

# eta/DYNAFORM

## *Training Manual*

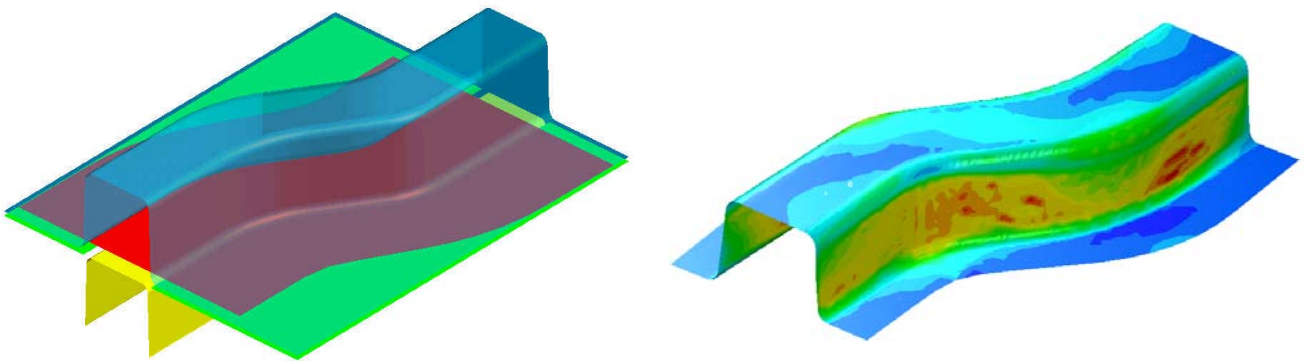

### Version 5.2

Engineering Technology Associates, Inc.  
1133 E. Maple Road, Suite 200  
Troy, MI 48083

Tel: (248) 729-3010  
Fax: (248) 729-3020  
Email: [support@eta.com](mailto:support@eta.com)

eta/DYNAFORM team  
November 2004

Copyright 1998, 1999, 2000, 2001, 2002, 2003, 2004 Engineering Technology Associates, Inc. All rights reserved.

# TABLE OF CONTENTS

INTRODUCTION .....	1
DATABASE MANIPULATION .....	2
I.    Creating an eta/DYNAFORM Database and Analysis Setup .....	2
II.   Practice Some Auxiliary Menu Operations.....	4
III.  Turning Parts On/Off .....	6
IV.  Editing Parts in the Database .....	7
V.    Current Part.....	9
MESHING .....	11
I.    Blank Meshing .....	11
II.   Meshing Surface Data.....	13
III.  Mesh Checking .....	16
IV.  QuickSetup vs. Traditional Setup .....	20
QUICKSETUP .....	22
I.    Define the Lower Ring from the Lower Tool .....	22
II.   QuickSetup interface:.....	27
III.  Define Tools .....	28
IV.  Defining the Blank Material .....	31
V.    Running the Analysis .....	35
TRADITIONAL SETUP .....	41
I.    Offsetting the Lower Tool Mesh to Create the Upper Tool .....	41
II.   Create the Lower Ring .....	44
III.  Separate LOWRING and LOWTOOL .....	48
IV.  Draw Type Setup.....	49
V.    Tool Definition.....	49
VI.   Defining the Blank and Setting up Processing Parameters.....	52
VII.  Tools Summary .....	56
VIII. Auto Positioning the Tools.....	57

IX.	Measuring the DIE Travel Distance.....	59
X.	Define DIE Velocity Curve.....	61
XI.	Defining the Binder (LOWRING) Force Curve .....	64
XII.	Preview Tool Animation .....	66
XIII.	Running the Analysis .....	67
POST PROCESSING (with eta/POST) .....		70
I.	Reading the Results File into the Post Processor .....	70
II.	Animating Deformation .....	72
III.	Animating Deformation, Thickness and FLD .....	73
IV.	Plotting Single Frames .....	76
V.	Writing an AVI and E3D File.....	77
MORE ABOUT DYNAFORM 5.2.....		80
CONCLUSION.....		81

# INTRODUCTION

Welcome to the **eta/DYNAFORM version 5.2** Training Manual. The **eta/DYNAFORM version 5.2** is the unified version of the DYNAFORM-PC and UNIX platforms. This manual is meant to give the user a basic understanding of finite element modeling for forming analysis, as well as displaying the forming results. It is by no means an exhaustive study of the simulation techniques and capabilities of **eta/DYNAFORM**. For more detailed study of **eta/DYNAFORM**, the user is urged to attend an **eta/DYNAFORM** training seminar.

This manual details a step-by-step sheet metal forming simulation process through traditional finite element (FE) modeling and the newer QuickSetup interface process. Users should take the time to learn both setup processes as each has inherent benefits and limitations.

The traditional setup procedure is extremely flexible and can be used to setup any forming simulation. Because the QuickSetup makes certain assumptions as to the type of tooling configuration selected it is not as flexible, however, it automates many of the procedures required for traditional model setup such as travel curves.

The following table outlines the major differences between the QuickSetup and the traditional setup procedure.

<b>QuickSetup</b>	<b>Traditional</b>
Automated interface limits flexibility	Manual interface can duplicate any tooling configuration; pads, multiple tools, etc
Reduces modeling setup time	Requires more setup time
Automated travel curves	Manual definition of travel curves
Contact Offset	Geometrical Offset

*Note: This manual is intended for the application of all **eta/DYNAFORM** platforms. Platform interfaces may vary slightly due to different operating system requirements. This may cause some minor visual discrepancies in the interface screen shots and your version of **eta/DYNAFORM** that should be ignored.*

# DATABASE MANIPULATION

## I. Creating an eta/DYNAFORM Database and Analysis Setup

### Start eta/DYNAFORM 5.2.

For workstation/Linux users, enter the command “df52” (default) from a UNIX shell.  
For PC users, double click the eta/DYNAFORM 5.2 (DF52) icon from the desktop.

After starting eta/DYNAFORM, a default database Untitled.df is created. Users will begin by importing CAD files to the current database.

### Import files

1. From the menu bar, select **File**⇒**Import**.

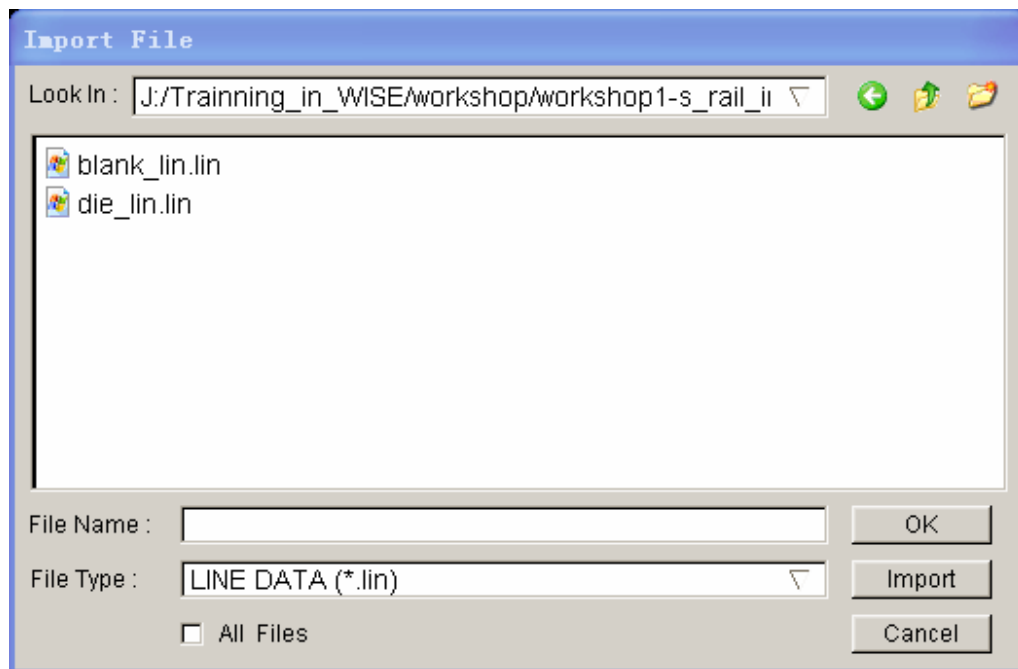

Change the file format to “LINE DATA (\*.lin)”. Go to the training input files located in the CD provided along with the eta/DYNAFORM installation. Locate two data files: die.lin and blank.lin. Then, import both files and select **OK** to dismiss the **Import File** dialogue window.

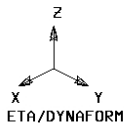
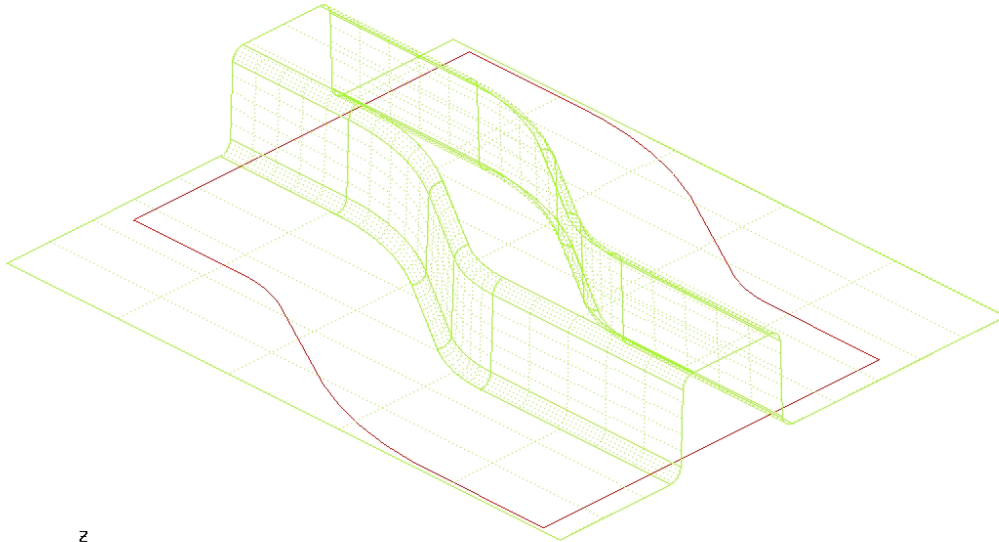

After reading in all of the data files, verify the display looks the same as the illustration shown above. The parts are displayed in the isometric view which is the default view setting of eta/DYNAFORM.

**Note:** *Icons may appear different depending on platform. Other functions on the **Toolbar** will be discussed further in the next section. You can also refer to the **eta/DYNAFORM User's Manual** for information on all of the **Toolbar** functions*

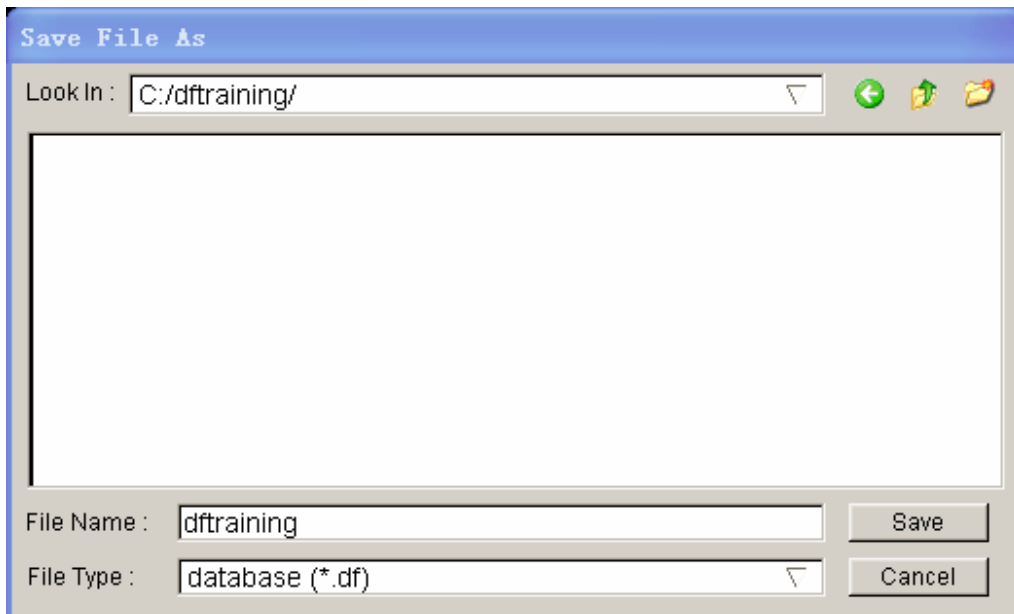

2. Save the database to the designated working directory. Go to **File**→**Save as**, type “dftrain.df”, and select **Save** to dismiss the dialogue window.

## Database metrics

The default unit system for a new eta/DYNAFORM database is **mm, Newton, second, and Tonne**. The default setting for draw type is **double action (toggle draw)**. The user is able to change these default settings from the **Tools**→**Analysis Setup** menu.

## File Types

eta/DYNAFORM has the ability to read the following types of input files:

- |                                |                                      |
|--------------------------------|--------------------------------------|
| 1. Abaqus (*.inp)              | 8. VDA (*.vda,vdas)                  |
| 2. LS-DYNA (*.dyn, *.mod, *.k) | 9. DYNAIN file (dynain*, *.din)      |
| 3. NASTRAN (*.nas, *.dat)      | 10. CATIA v4/v5 (*.model, *.CADPart) |
| 4. Stereo lithograph (*.stl)   | 11. ProE (*.prt, *.asm)              |
| 5. Autocad (*.dxf)             | 12. STEP (*.stp)                     |
| 6. Line Data (*.lin)           | 13. Unigraphics (*.prt)              |
| 7. Iges (*.igs, *.iges)        | 14. dynain file                      |

## II. Practice Some Auxiliary Menu Operations

After successfully reading in the needed files to begin the finite element modeling, practice to get familiar with some of the basic functions and menus.

### View Manipulation

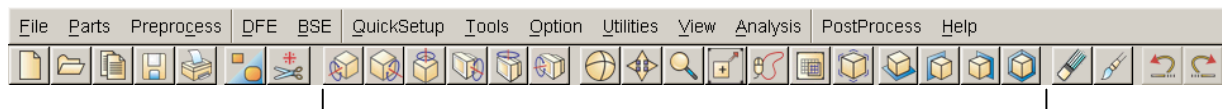

### View Manipulation

The view manipulation area of the **Toolbar** is one of the most visited spots in eta/DYNAFORM. These functions enable the user to change the orientation of the display area. Place the mouse pointer over each icon to display the name and function of each icon. Also, take notice of the **Display Options** area (shown below) at the bottom right hand side of the screen. This is another area enabling the user to manipulate the display area.



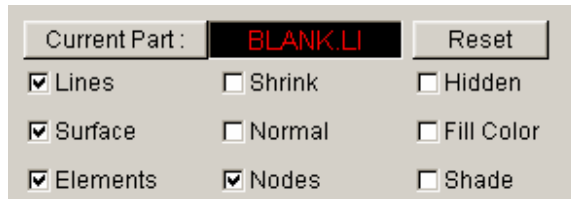

The following steps will help you become more familiar with the functions found in the **Toolbar**, and in the **Display Option** window.

1. Select **Isometric** from the **Toolbar**. This places the displayed geometry in an isometric view, as shown earlier. The function is shown below:



2. Rotate the geometry dynamically about the z-axis approximately 90° by using the **Rotate about Z-Axis** function. The function is shown below:

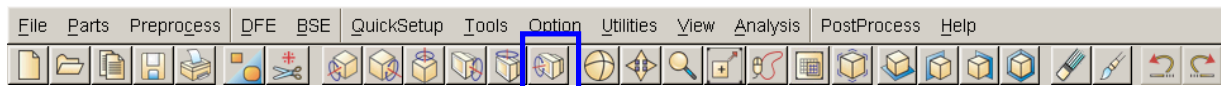

3. Select **Right View (YZ Plane)**. The result is shown below:

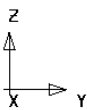
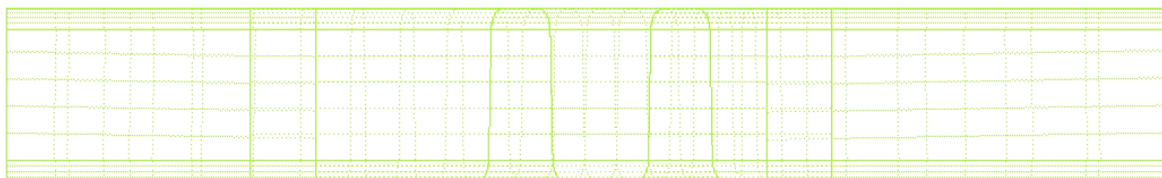

ETA/DYNAFORM

4. Select **Free Rotation to rotate the model**.

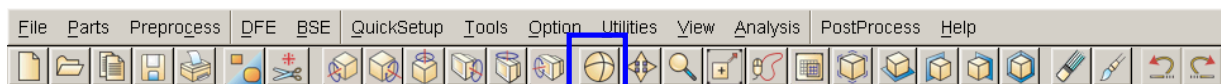

5. Select **Fill Screen** from the **Toolbar**, this makes the displayed geometry fill the screen.



6. Practice using the other viewing options before moving on.

### III. Turning Parts On/Off

All geometry in eta/DYNAFORM is arranged based on parts. Every entity, by default, will be created or read into a part. The user should practice using the **On/Off** function, located in the **Toolbar**,

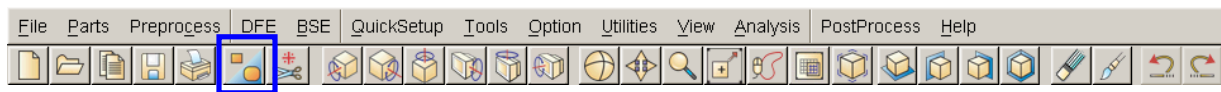

or in the Parts menu: **Parts**→**Turn On**.

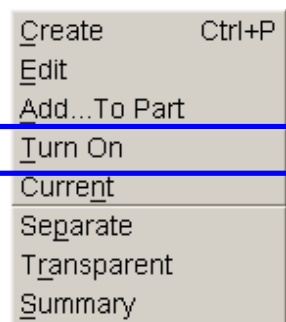

1. Notice the **Turn On/Off Part** dialogue that appears after selecting the **Part On/Off** button.

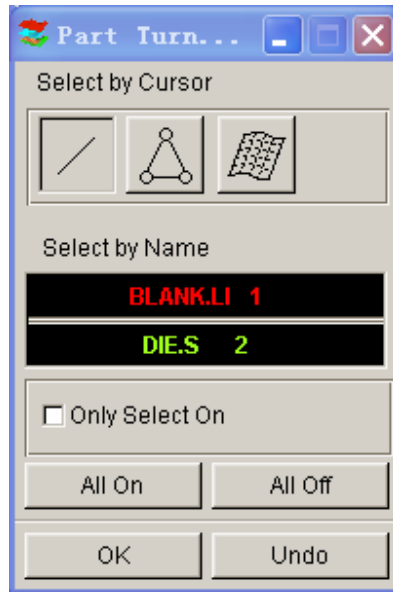

Place the cursor over different icons and buttons to learn the name of each function. This type of selection menu is common in the eta/DYNAFORM environment. It provides several different functions for selecting which parts will be turned off or on.

2. Since the part **BLANK.LIN** contains only line data, you will have to use either the **Select by Line** or the **Select by Name** function.
3. First, use the **Select by Line** icon to turn off the part, **BLANK.LIN**. Click the **Select by Line** icon, and select a line in the part, **BLANK.LIN**. The part will be turned off.
4. Next, use the **Select by Name** function, and select **BLANK.LIN** from the list in the window. In the **Select by Name** window, the parts that are turned on are displayed in their color and the parts that are turned off are displayed in white.
5. Before we continue, verify that all available parts are turned on. Select the **All On** button from the **Turn On/Off Part** dialogue.
6. After you have turned all the parts on, click the **OK** button on the **Turn On/Off Part** dialogue. This will end the current operation

#### IV. Editing Parts in the Database

The **Edit Part** command is used to edit part properties and delete parts.

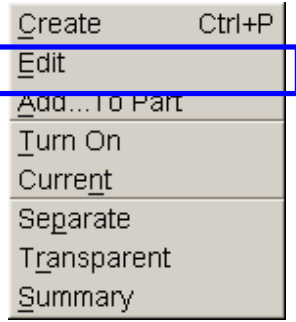

1. From the above menu, click the **Edit** button.

The **Edit Part** dialogue will be displayed, with a list of all the parts that are defined in the database. The parts are listed with the part name and identification number. From here, you can modify the part name, ID number and part color. You can also delete parts from the database.

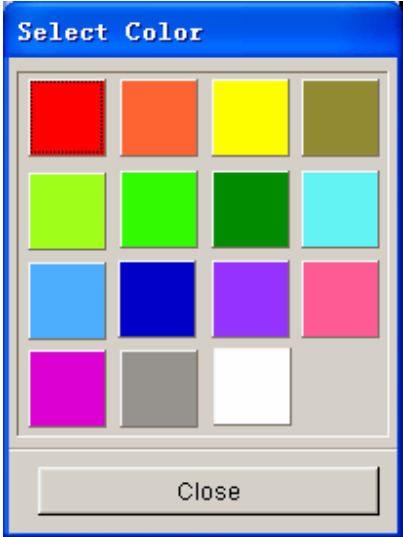
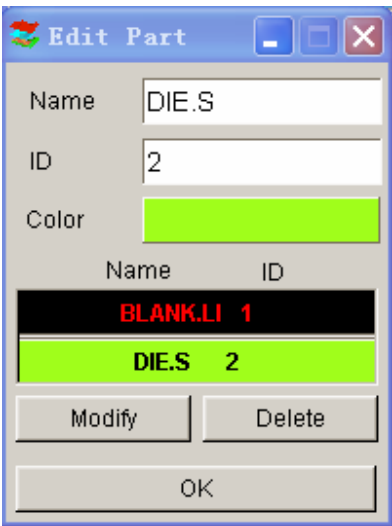

- 2. Select the part **DIE.S** from the part list. Change its color by clicking on the Color button and selecting a new color from the palette.
- 3. Select the part **DIE.S** from the part list. Change the **Name** by inputting **LOWTOOL** in the field as shown below.

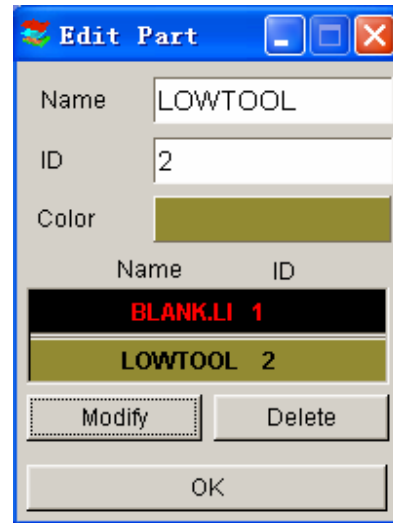

4. Once you have entered the new name (**LOWTOOL**) and selected the desired part color, click on the **Modify** button located at the bottom left of the dialogue to make the changes.
5. Click **Close** to end this operation.
6. Save your database.

***Note:** Designers often model only one surface of upper or lower die. The other die face will offset from the mating surface. In this case, we suppose the surface is the lower tool. And the upper tool will offset from the surface later. So we give the part name **LOWTOOL**.*

## V. Current Part

All lines, surfaces, and elements which were created will automatically be placed into the current part. When creating new lines, surfaces, or elements, always make sure the desired part is set as current.

***Note:** When auto-meshing surfaces, the user does have the option of assigning the created mesh to the parts that contain the individual surface data. In other words, you can keep the mesh in the original parts, rather than have them all created in the current part. This will be dealt with later.*

1. To change the current part, click on the **Current Part** dialogue in the **Display Options** dialogue.

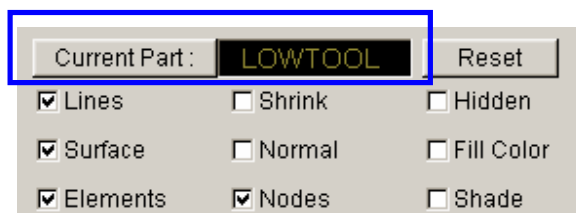

Or select **Parts**⇒**Current** on **Menu bar**

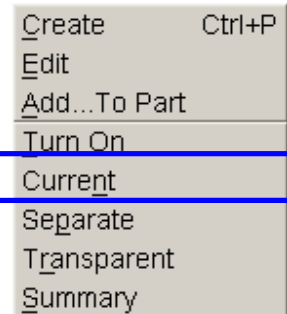

2. The **Current Part** dialogue window will be displayed.

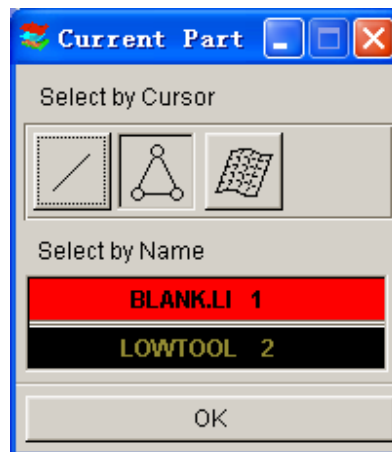

3. Similar to the **Part On/Off** window, this window allows you to select the current part in different ways. Place the cursor over each icon to identify its function.
4. Set the part **BLANK.LI** as current by selecting the part name from the **Select by Name** list that is displayed.
5. Practice setting the current part.
6. Turn off all of the parts except **BLANK.LI**, and set it as current.

# MESHING

Meshing from surface or line data is a very important step contributing to a successful simulation. There are many methods of creating mesh, however in this exercise, the Blank Generator and Surface Mesh will be used to generate meshes.

## I. Blank Meshing

Blank meshing is the most important mesh function since the accuracy of the forming results depends heavily upon the quality of blank mesh. There is a special function for blank meshing.

1. Select **Tools**→**Blank Generator** on **Menu bar**.
2. There are four lines in **BLANK.LI** so select the **BOUNDARY LINE** from the **Select Option** dialogue.

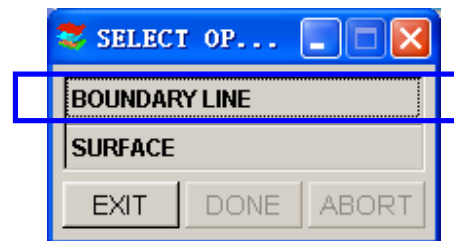
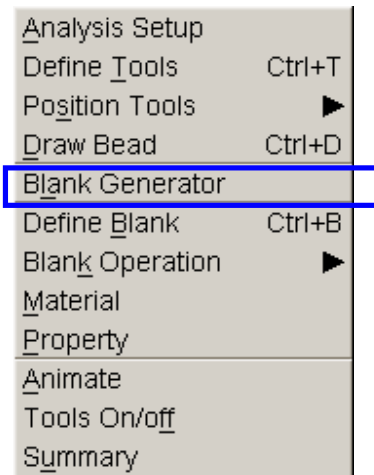

3. The **Select Line** dialogue window is shown as below.

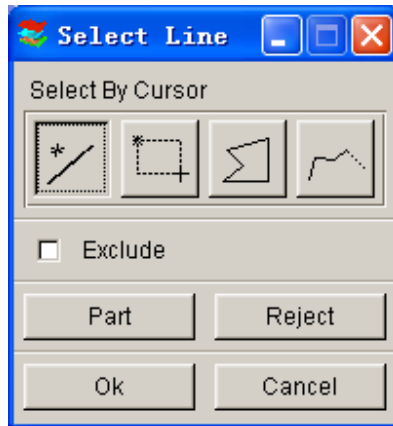

There are 4 lines in the part. Select the lines, one-by-one by left clicking on them. This Select Line dialogue window allows you to select the line(s) in different ways. Place the cursor over each icon and button to identify its function.

4. Select **OK** after selecting all four lines.
5. Use the default variable (6.0) for the concerned tool radii. This number reflects the tightest radii in the model. The smaller the radii the finer the blank mesh; a larger value will result in coarser mesh.



6. After you have entered the variable, press **OK**. A **Dynaform Question** dialogue prompts “**Accept Mesh?**”.

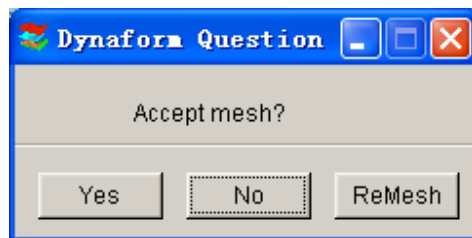

Press **YES** to accept the mesh.

If you have entered an incorrect value, click on the **ReMesh** button to correct the concerned tool radii value and accept the mesh, or **No** to cancel it and repeat the above steps to re-mesh.

7. Compare your mesh with the following picture.



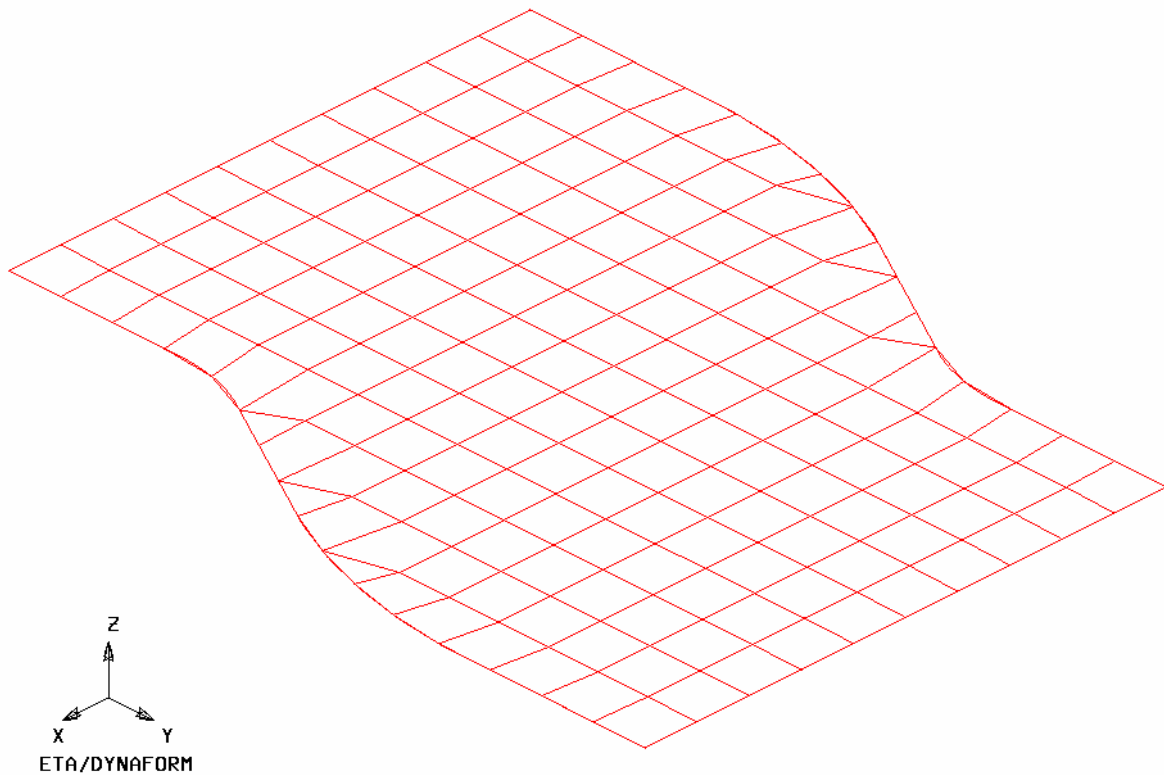

8. Save the database.

## II. Meshing Surface Data

Most of the meshing done in eta/Dynaform is carried out using the **Surface Mesh** function. This function will automatically create a mesh based on the provided surface data. This is a very quick and easy way of meshing the tools.

1. Turn off the part **BLANK.LI** and turn on the part **LOWTOOL**. Set the part **LOWTOOL** as current.
2. Select **Preprocess** ➔ **Elements** on **Menu bar**.

Line/Point	Ctrl+L
Surface	Ctrl+S
<b>Element</b>	<b>Ctrl+E</b>
Node	Ctrl+N
Mesh Repair	Ctrl+R
Model Check	Ctrl+M
Boundary Condition	Ctrl+U
Node/Element Set	Ctrl+V

3. Select **Surface Mesh** from the **Element menu** as shown below.

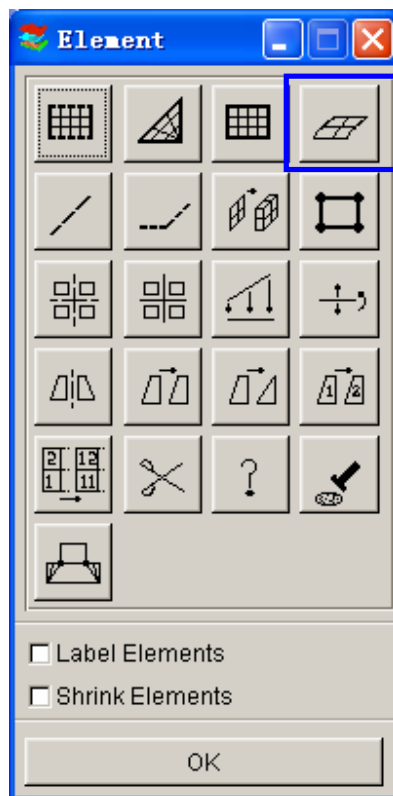

4. In the displayed **Surface Mesh** dialogue window, default values will be used for all fields. Toggle off the **in Original Part** option, toggle off the **Boundary Check** option dialogue,

**Note:** *Chordal deviation* controls the number of elements along the line/surface curvature;  
*Angle* controls the feature line, ;  
*Gap Tol.* Controls whether two adjacent surfaces are connected.

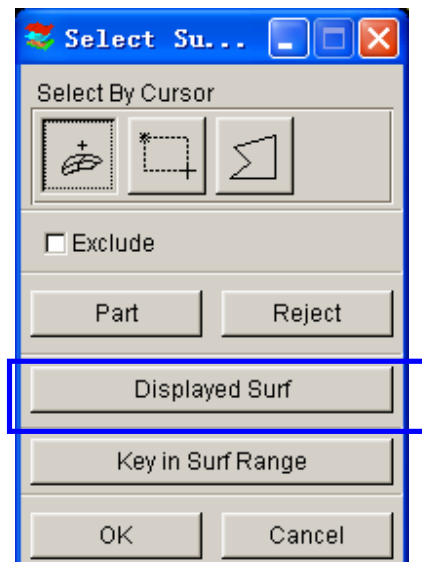
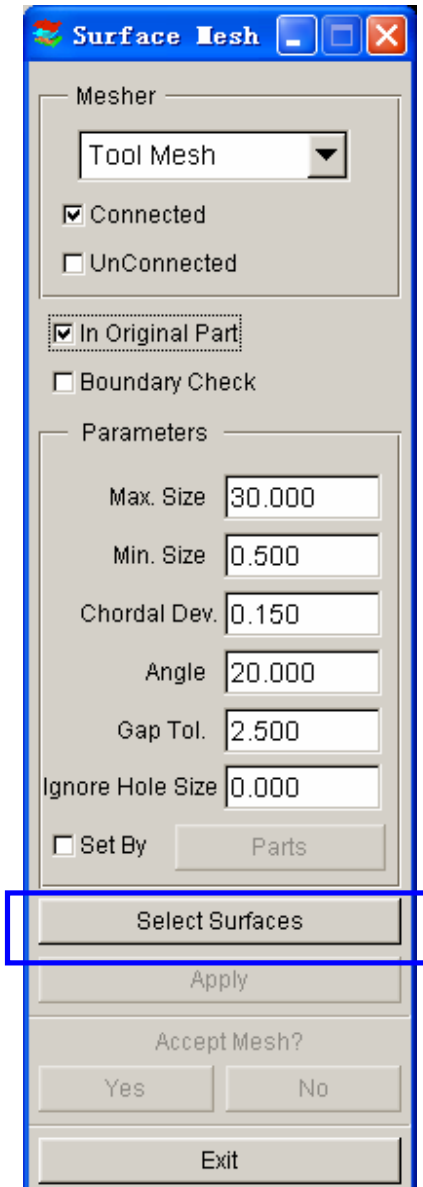

5. Choose the **Select Surfaces** button from **Surface Mesh** dialogue.
6. From the **Select Surface** dialogue, choose the **Displayed Surf** icon

Notice all of the displayed surfaces will turn white. This verifies they have been selected. This dialogue window allows you to select the surface(s) in different ways. Place the cursor over each icon and button to identify its function.

7. Click **Apply** button on the **Surface Mesh** dialogue.

- The mesh will be created and will be displayed in white. To accept the mesh, click the **Yes** button when prompted, “**Accept Mesh?**” in the **Surface Mesh** dialogue. Check your mesh with the mesh displayed below.

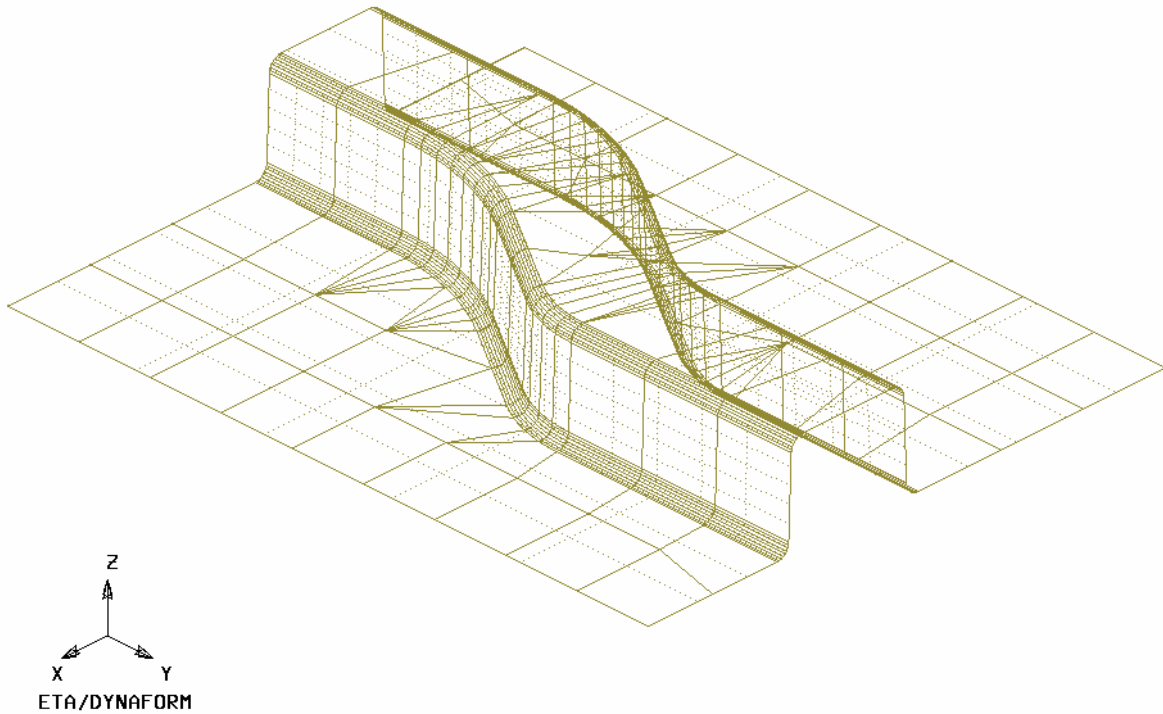

- Press **Exit** on the **Surface Mesh** dialogue to exit the function.

Now that we have all the parts meshed, you can turn off the surfaces and lines by turning off **Surfaces** and **Lines** in the **Display Option** dialogue. This makes it easier to view the mesh. Save the changes.

- Save the database.

### III. Mesh Checking

As the mesh has been created, its quality has to be checked to verify that there aren't any defects that could cause potential problems in the simulation.

All the utilities used for checking the mesh are located under the **Preprocess**⇒**Model Check** on the **Menu bar**.

Line/Point	Ctrl+L
Surface	Ctrl+S
Element	Ctrl+E
Node	Ctrl+N
Mesh Repair	Ctrl+R
<b>Model Check</b>	<b>Ctrl+M</b>
Boundary Condition	Ctrl+U
Node/Element Set	Ctrl+V

As shown above, the Model Check dialogue consists of several functions that enable the users to check the quality of mesh. Only two of the functions are described in this training manual. Please refer to **eta/DNAFORM online help** for information regarding to the remaining functions.

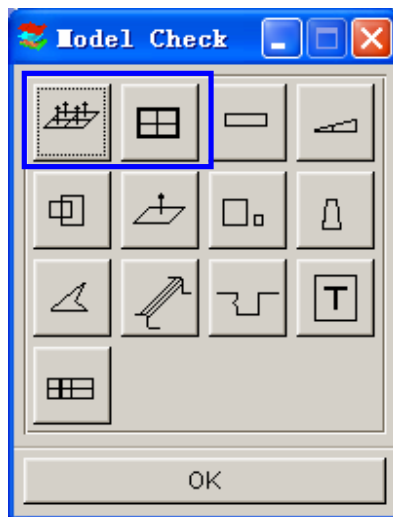

### **Auto Plate Normal**

1. Select **Auto Plate Normal** from the **Model Check** dialogue. A new dialogue will be displayed.
2. The displayed dialogue prompts you to pick an element to check all the active parts or an individual part for element normal consistency. Select an element on the part **LOWTOOL**.

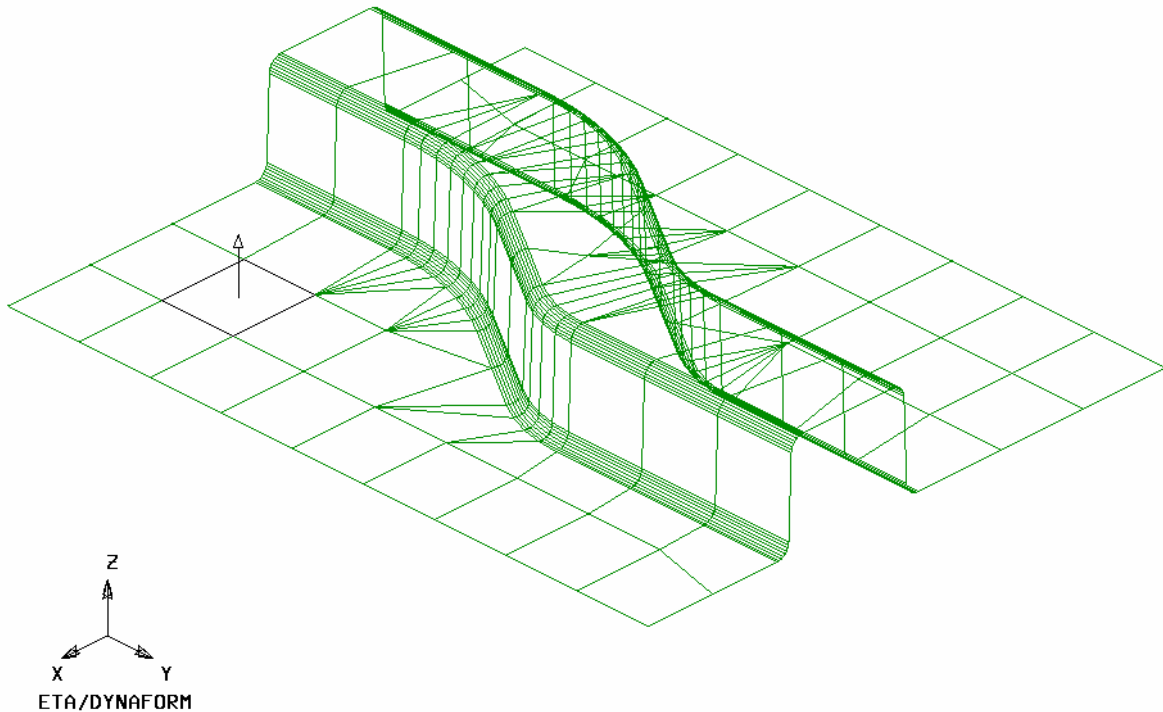

3. An arrow will be displayed showing the normal direction of the selected element. A prompt will ask “**IS NORMAL DIRECTION ACCEPTABLE?**” Click No reject that direction.

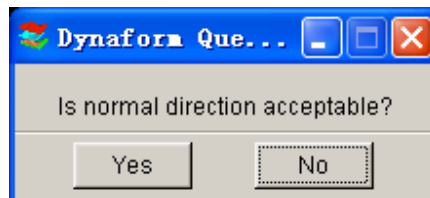

Pressing **YES** will check all elements in the part and reorient as needed to the direction that is displayed. Pressing **NO** will check all elements and reorient as needed to the opposite of the direction that is displayed. In other words, press **YES** if you want the normal to point in the direction of the displayed arrow, or **NO** if you want it to be the opposite. As long as the normal direction of most elements in a part is consistent, program will accept that. If half of the total element’s normal is pointing upper ward and other half pointing downward, program will be confused how to constrain the blank through contact.

**Note:** *In this case, we will offset upper tool from the lower tool by the normal direction. So select **YES** to make sure the normal to point in the direction of the displayed arrow.*

- Now that the **LOWTOOL** elements are consistent, check the rest of the parts in the database. Turn off all the parts and turn each one at a time. Check the normal direction and make sure it is consistent.
- Once all the normal directions are consistent, turn on all of the parts and save the changes.

### Display Model Boundary



This function will check the mesh for any gaps or holes, and highlight them so you can manually correct the problem.

- Select **Display Model Boundary** from the **Model Check** dialogue window.
- Minor gaps in the tool mesh are acceptable. Blank mesh should not contain any gaps unless the blank is lanced or is designed with gaps. Select the isometric view and make sure that your display looks like the following.

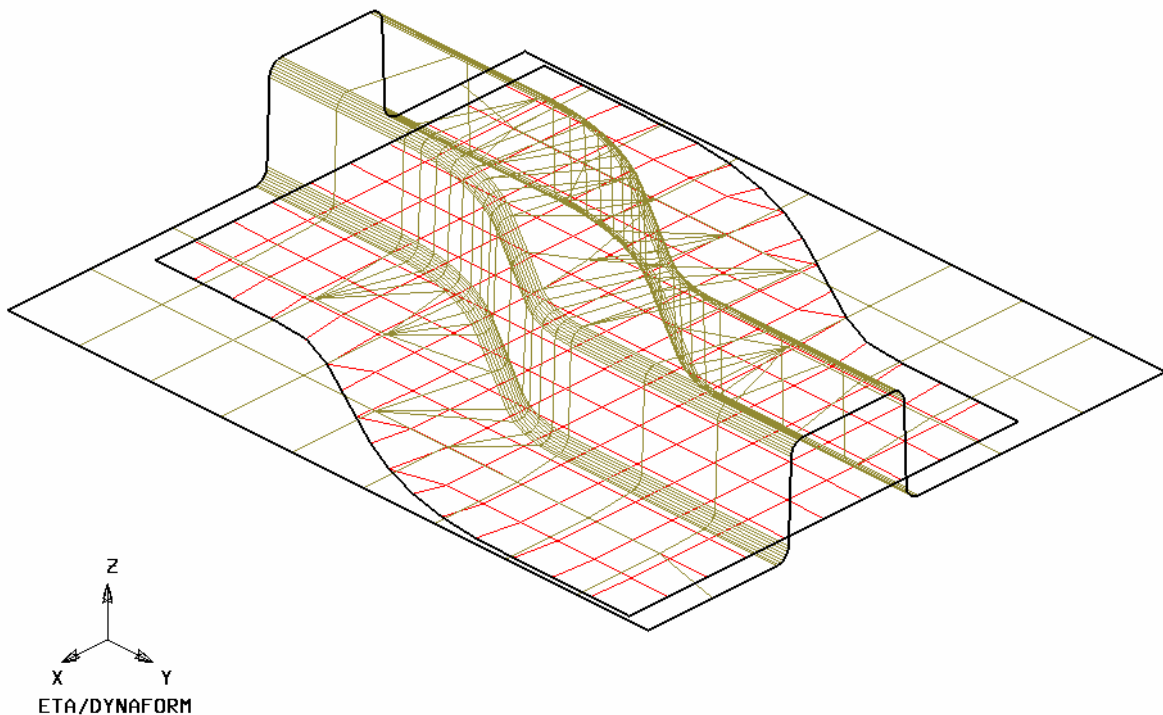

- Turn off all of the elements and nodes from the **Display Options** dialogue (**Note:** the boundary lines are still displayed). This allows you to inspect any small gaps that might be difficult to see when the mesh is displayed. The results are shown in the following picture.

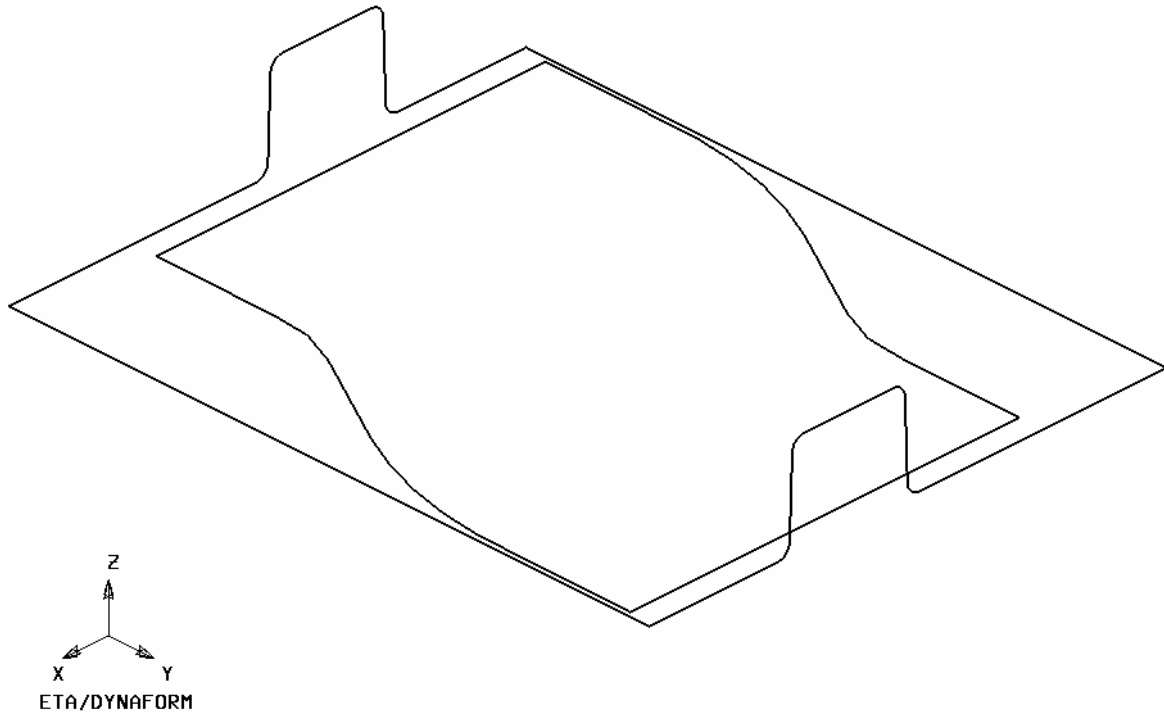

4. Check for overlapping elements and minimum element size. Delete the duplicate elements if there were found.
5. Turn only the part **LOWTOOL** on and click the **Clear** icon on the **Toolbar** to remove the boundary lines.



6. Save your database.

#### IV. QuickSetup vs. Traditional Setup

The analysis setup depending on whether the user is going to use QuickSetup or Traditional setup. Save the changes to your initial database and make a note of this file name. We will use this file later in this training manual to perform a manual setup. Now use the Save As function to save this as another duplicate database that we will use for the QuickSetup portion of this manual, for example, dftraining\_qs.df. The new database name and directory path should be displayed in the upper right portion of the DYNAFORM interface.



This manual will first detail the QuickSetup process, then the Traditional setup. Skip to the Traditional Setup portion (page 41) of this manual if you are already familiar with the QuickSetup interface and analysis setup procedure.

# QUICKSETUP

Before entering the QuickSetup interface we will need to separate the binder run-out (lower ring) from the lower tool. This will allow the QuickSetup to automatically offset the upper binder from this run-out. This procedure is common to all QuickSetup models that require a binder.

## I. Define the Lower Ring from the Lower Tool

Next step is to separate the **Lower Ring** from the **LOWTOOL**, and Move Elements on Run-out of **LOWTOOL** into **Lower Ring**.

1. Turn on **LOWTOOL** and turn off all other parts.
2. Create a new part called **LOWRING**. This part will hold the elements that we separate from the **LOWTOOL**. Click **Parts**⇒**Create** on **Menu bar**.

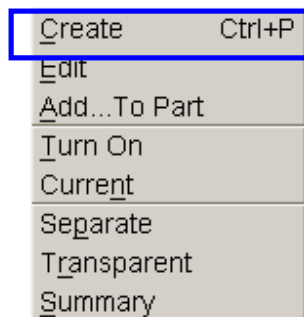

3. Enter **LOWRING** in the name field. Click **OK** to create the part.

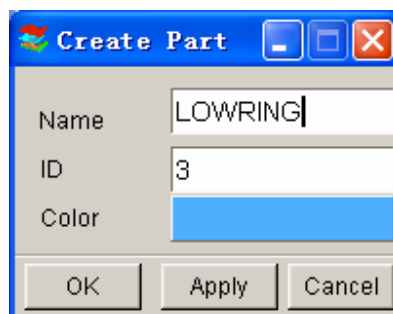

4. The part **LOWRING** has been created and set as the current part automatically. We can now place the lower ring elements in this part.

5. Click on **Parts**⇒**Add... To Part** on Menu bar.

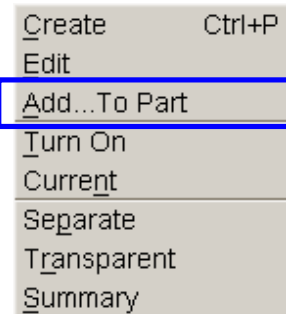

6. The **Add...To Part** window appears as follows. Click the **Element(s)** button as shown below.

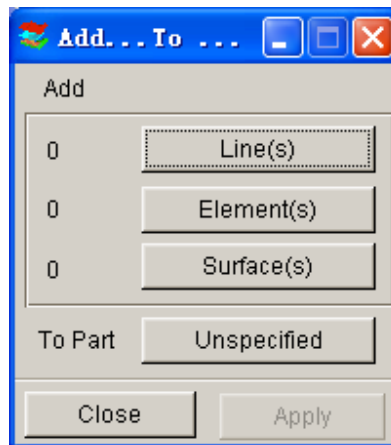

7. The program displays the **Select Elements** window as shown in next page. The easiest way to select all elements of the ring is to switch the view to the **YX plane** on the **Tool Bar**, then select the **Spread** icon, press and drag the left mouse button on the **Angle Slider** to set a small angle. Since the Ring surface is flat, set the smallest angle you can select (e.g. 1 as one degree).

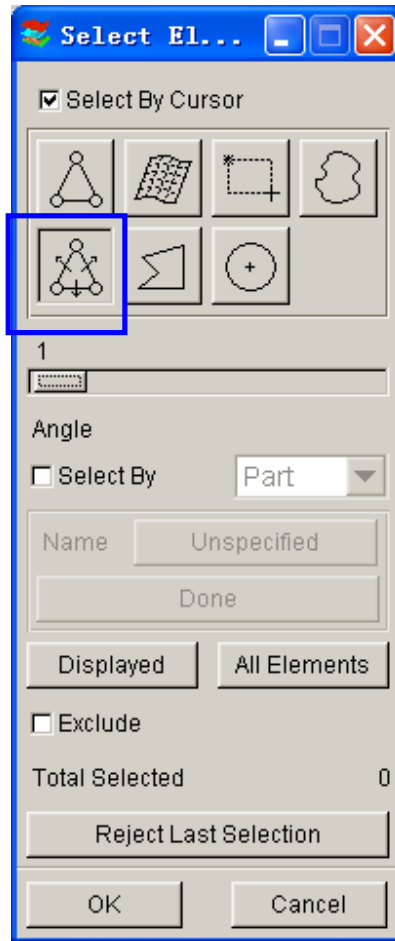

8. Click any element on the right-ring of **LOWTOOL**.

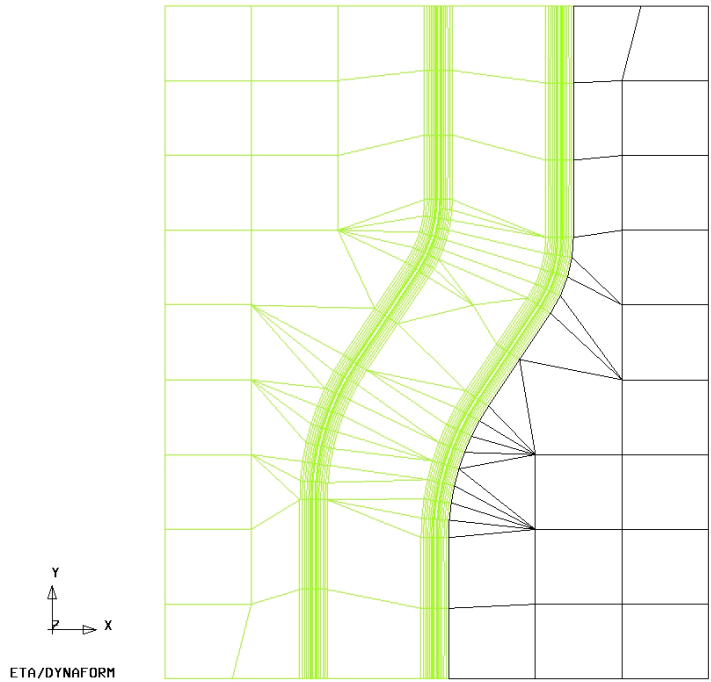

All elements in the flat area before an element angle change of larger than 1 degree should be highlighted. Compare your display to the preceding image. If your results differ, repeat the above steps to re-select.

- 9. Click any element on the left-ring of **LOWTOOL**.
- 10. Select **OK** on the **Select Elements** window. You will find the number of elements (67) is shown on the left side of the **Element(s)** button as below.
- 11. Select the **Unspecified** button.

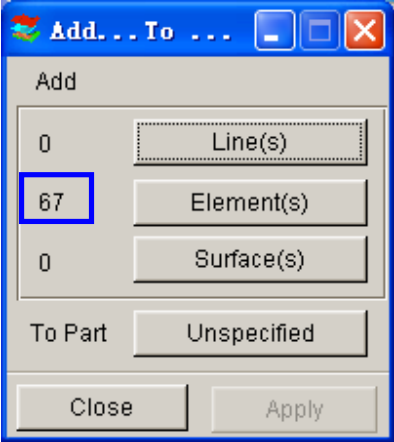

12. Dynaform displays the **Select Part** window. Select **LOWRING** in the **Select by Name** list. The program changes the **Unspecified** button will change to **LOWRING**.

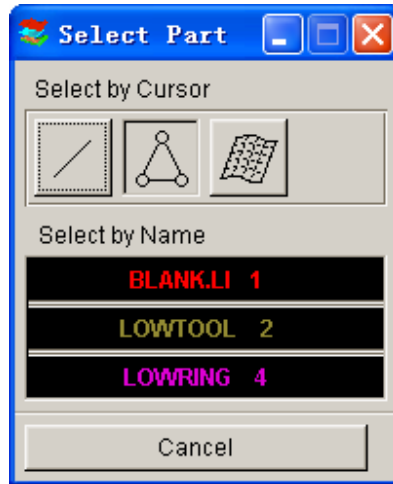

13. Click **Apply**, all selected elements are moved into **LOWRING**.

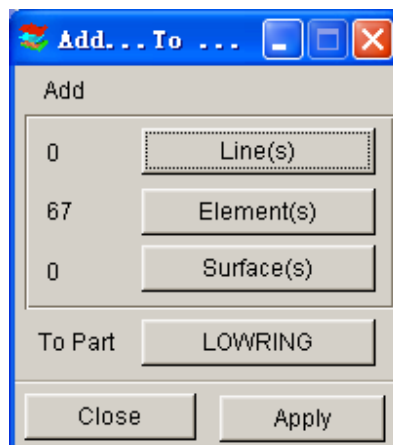

14. Turn on only **LOWRING** and display the part using Top view. The program displays the result as the following. If the result differs, repeat the above steps.

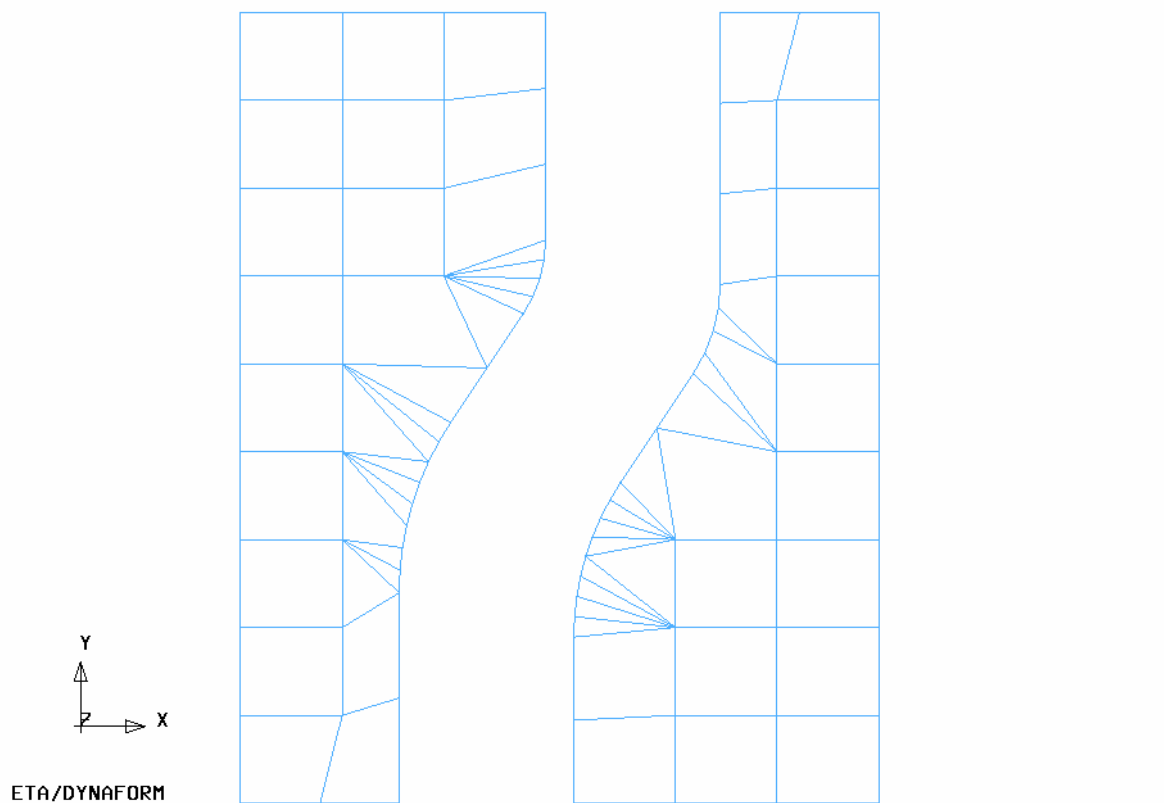

15. Save the changes.

## II. QuickSetup interface:

1. Select the **QuickSetup** menu, **QuickSetup**→**Draw Die**.

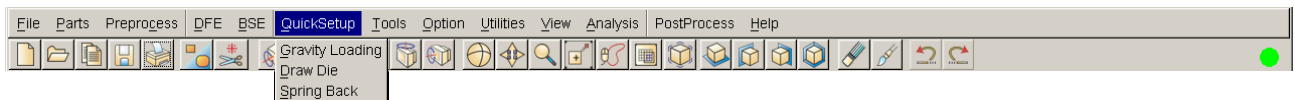

2. As shown in the following QS menu, the undefined tools are highlighted in red. The user needs to select the **draw type** and **available tool** first. In this application, the draw type is “**Single action**” or **Inverted draw**. The available tool is the **lower tool**.

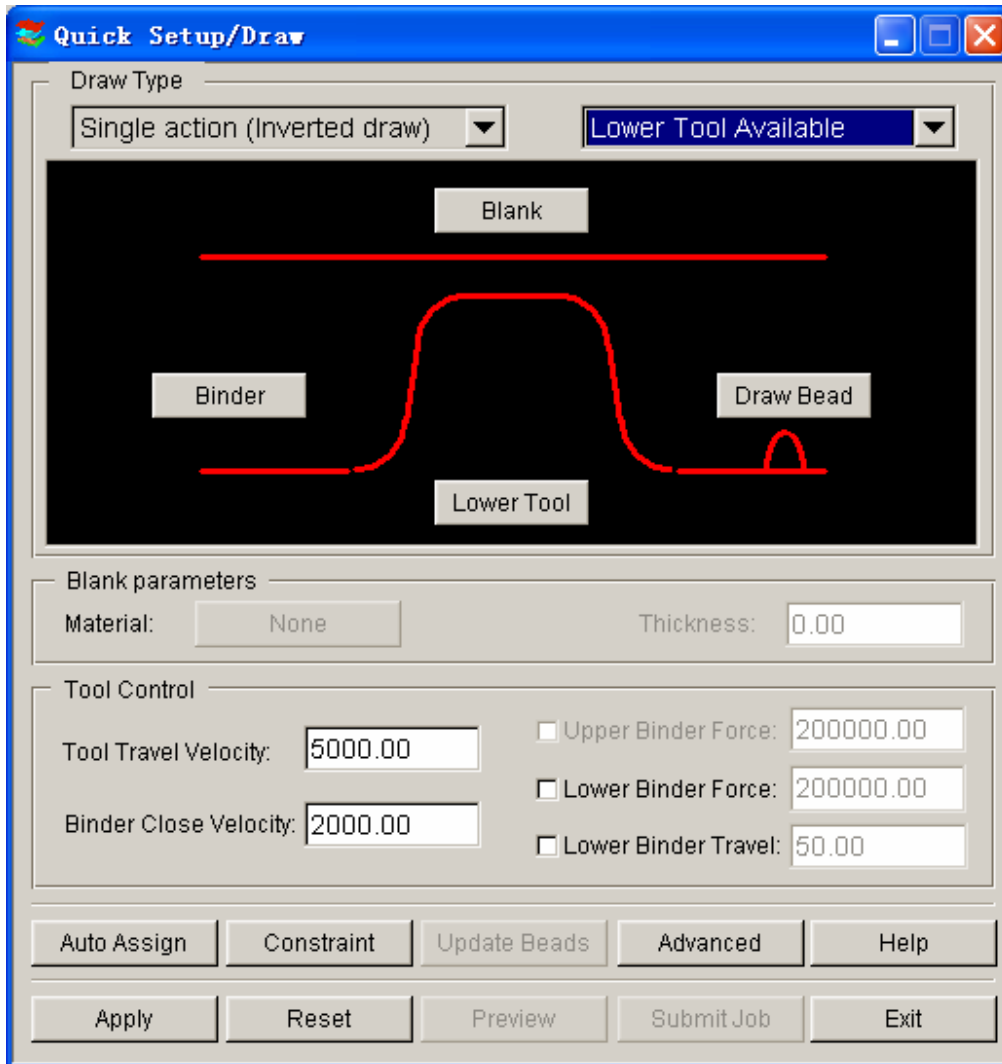

3. Define the blank and tools by clicking the appropriate buttons.

### III. Define Tools

The parts **LOWTOOL** and **LOWRING** are meshed and can be defined as the Binder and Lower Tool, respectively.

To define the Binder:

1. Click the **Binder** button, then select **SELECT PART button** from the **DEFINE TOOL dialog** window.



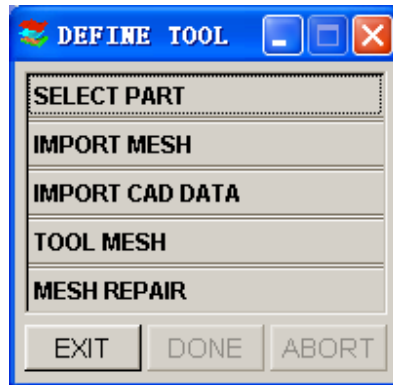

2. **Add** from the **Define Binder** window.

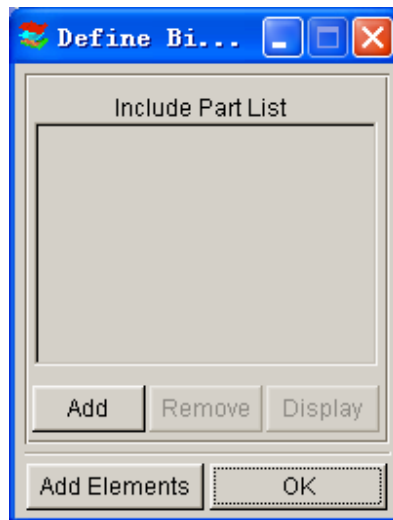

3. Select the part name from the part list: **LOWRING**.

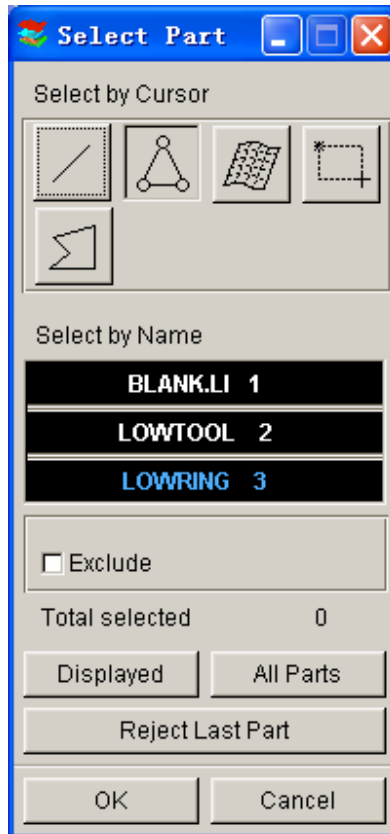

Repeat the same procedure to define the **Lower Tool**. Once both tools have been defined, the color in the Quick Setup/Draw window will be changed to green as shown in the following picture.

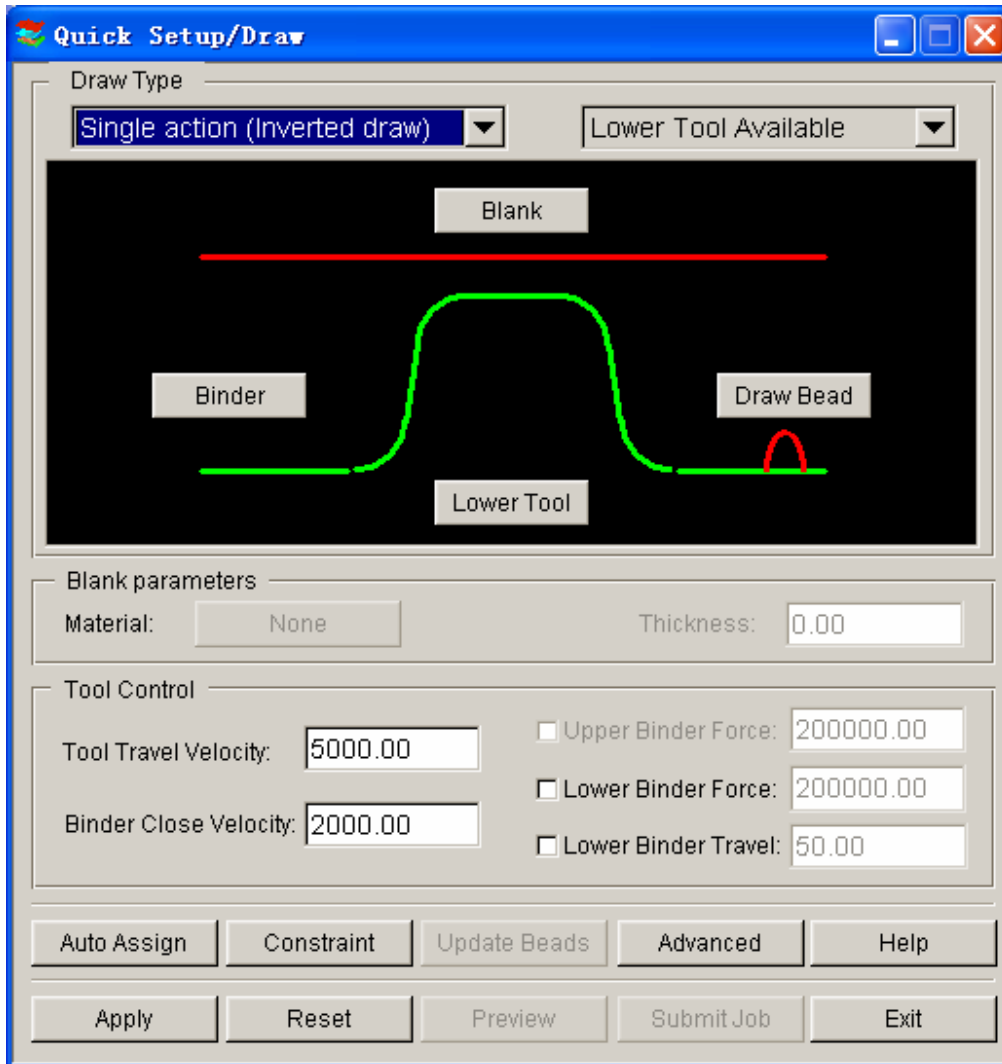

#### IV. Defining the Blank Material

1. Click the **Blank** button from QS GUI, and click “**SELECT PART**” from the **Define Blank** dialogue.
2. Click “**Add**”, and pick the blank part name.
3. The user needs to define the material and thickness. For the blank thickness the user may enter the number in the thickness field. In this case, we will use the default value of 1mm.
4. The blank material can be selected from the **Material Library** under the material definition window.

The Material Library will be shown as in the image below. Select the **mild steel “DQSK”**

under material type 36(**Note:** material type 36 and 37 are recommended for most simulations).

Strength Level	Material Name	Type 1	Type 18	Type 24	Type 36	Type 37	Type 39	Type 64	
		ELASTIC	POWER	LINEAR	3-PARAM	ANISOTR	FLD_TRA	RATE_SEN	
STEEL	Mild	CQ	+	+	+	+	+	-	-
		DQ	+	+	+	+	+	-	-
		DQSK	+	+	+	+	+	-	-
		DDQ	+	+	+	+	+	-	-
	Medium	BH180	+	+	+	+	+	+	-
		BH210	+	+	+	+	+	+	-
		BH250	+	+	+	+	+	+	-
		BH280	+	+	+	+	+	+	-
	High	HSLA250	+	+	+	+	+	+	-
		HSLA300	+	+	+	+	+	-	-
		HSLA350	+	+	+	+	+	-	-
		HSLA420	+	+	+	+	+	-	-
	Advanced High	DP500	+	+	+	+	+	-	-
		DP600	+	+	+	+	+	-	-
	Hot Rolled	CQ	+	+	+	+	+	-	-
		DQSK	+	+	+	+	+	-	-
		DDQIF	+	+	+	+	+	-	-
		HSLA400	+	+	+	+	+	-	-
	Stainless	SS11CrCb	+	+	+	+	+	-	-
		SS18CrCb	+	+	+	+	+	-	-
SS304		+	+	+	+	+	-	-	
SS409NI		+	+	+	+	+	-	-	
ALUMINUM	AA5182	+	+	+	+	+	-	-	
	AA5454	+	+	+	+	+	-	-	
	AA5754	+	+	+	+	+	-	-	
	AA6009	+	+	+	+	+	-	-	

5. Select **OK** to use the default material parameters (following image) for the DQSK material model (**Note:** ETA makes no guarantees as to the validity or accuracy of the generic material models in the material library. Users should contact their material suppliers to determine material parameters). To complete the material definition, select OK from the material dialogue and return to the QuickSetup interface. Save the changes.

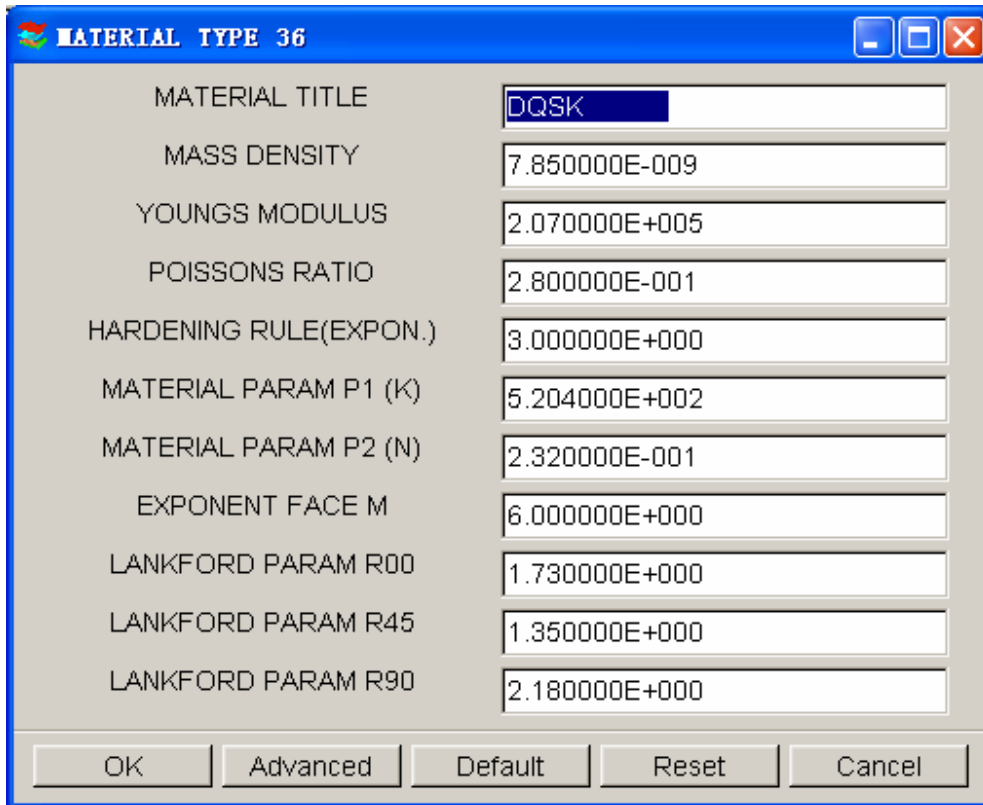

The following are the description of other functions in the QS interface:

- **Auto Assign** will assign parts as tooling that follow the QuickSetup default naming convention; for example, if the blank part name is named “BLANK”, once the auto assign button is selected, the part “BLANK” will be defined as the model BLANK. “DIE” and “BINDER” are the other tooling names recognized and automatically assigned. Drawbeads are not recognized by the Auto Assign function.
- **Constraint** allows the user to define SPC (single point constraint) for symmetric or other boundary conditions.
- **Advanced** allows the user to change default parameters related to QuickSetup.
- **Apply** automatically offsets all defined tooling with its mating tool and defines the travel curves.
- **Reset** deletes all mating tools and travel curves “resetting” the database to the state it was before the apply button was selected.
- **Preview** allows the user to animate and check the tooling travel curves.
- **Submit job** brings the user to the analysis menu.
- **Exit** will allow the user to exit the QS menu.

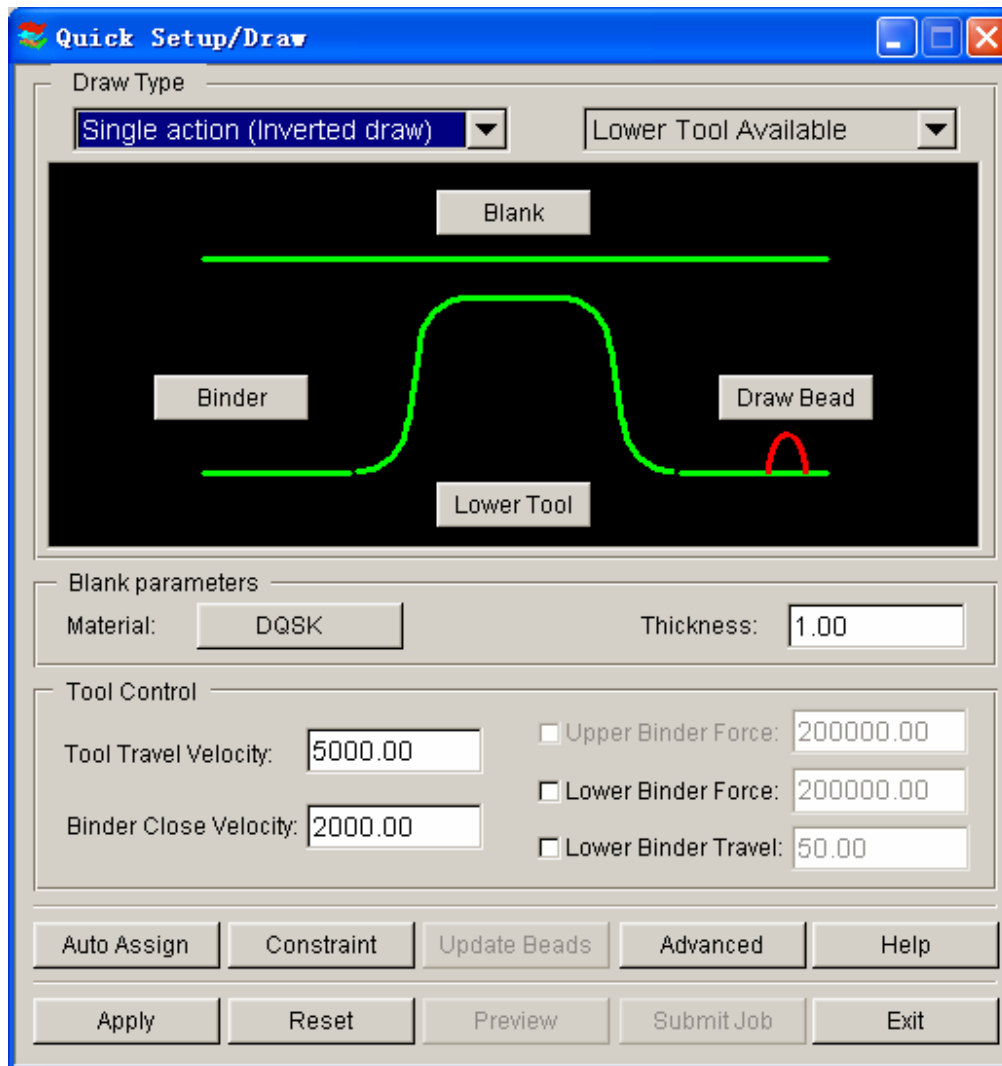

6. Now back to our exercise: Select **Apply**; the program will automatically create mating tools, position the tools and generate the corresponding travel curves.
7. Select **Preview** to check the tooling motion.
8. Compare your display with the illustration as shown below.

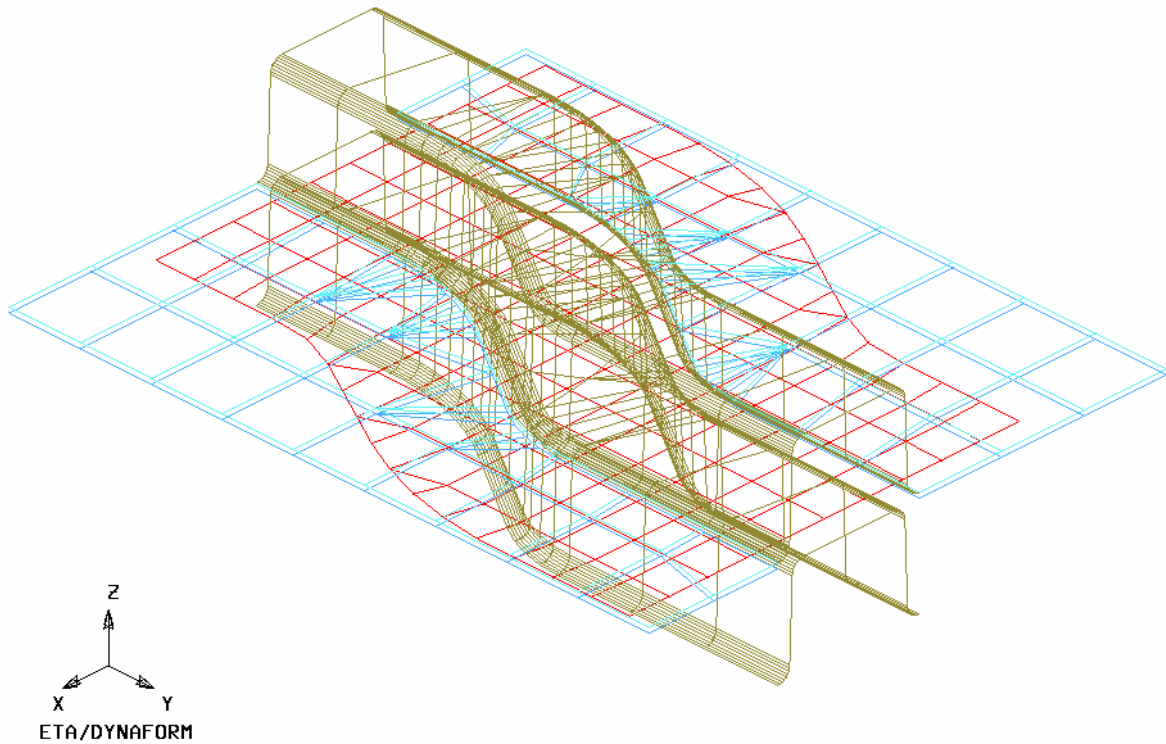

## V. Running the Analysis

After verifying the tool motion is correct, we can define the final parameters and run the analysis.

1. Click **Submit Job** button to display the “**Analysis**” dialogue window shown on next page.

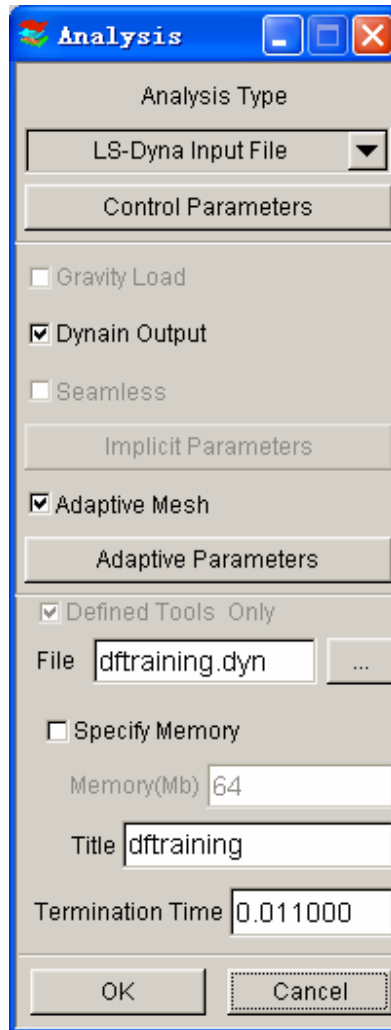

2. Click the **Control Parameters** button in the **Analysis** dialogue.

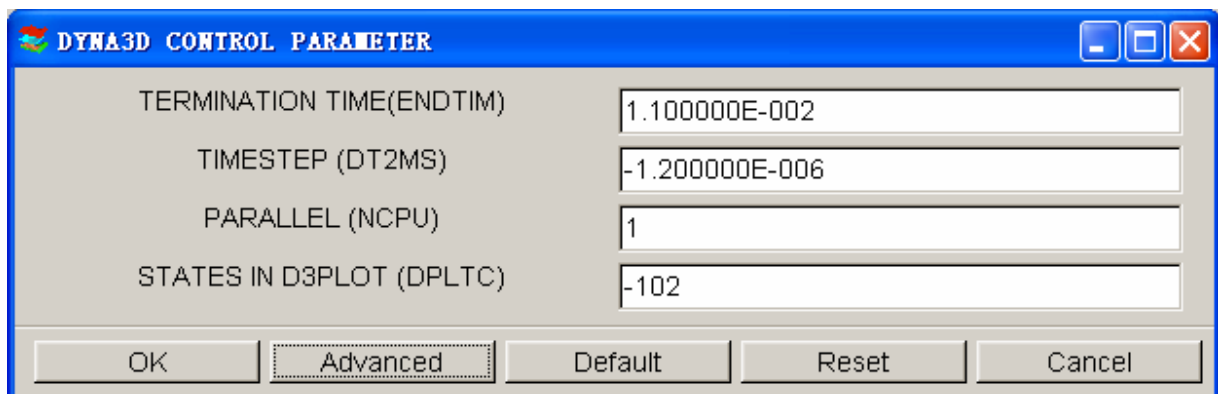

As a new user, it is recommended that you use the default control parameters (for more information on them, please refer to the *LS-DYNA User's Manual*). Click **OK**.



- By default, the **Adaptive Mesh** option is checked. Adaptive mesh allows for more accurate results by re-meshing the blank as needed. In other words, as the die deforms the blank, areas that demand a finer mesh to capture the tooling geometry will divide to create finer and smaller elements.
- Click **Adaptive Parameters** to display the **ADAPTIVE CONTROL PARAMET** dialogue window. Set the **LEVEL (MAXLVL)** to be 3. This means that the mesh will split up to 2 times if needed. Higher levels of adaptivity will result in better accuracy but require longer processing time. Since this is a simple part, level 3 will be sufficient. The default values will be used for other parameters. Click **OK**.

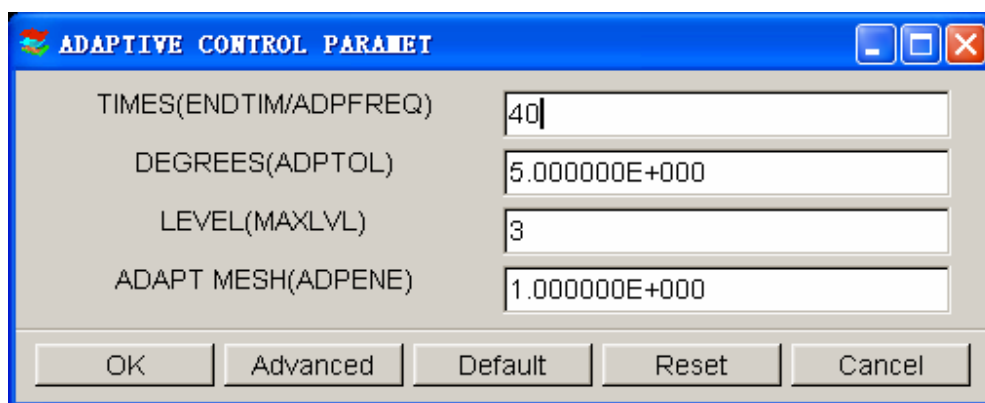

- To submit the job, select **Full Run Dyna**. Toggle on “**Specify Memory**” check box and key in **120** (Mb). Then, click **OK** to run the job. The solver will now be running in the background.

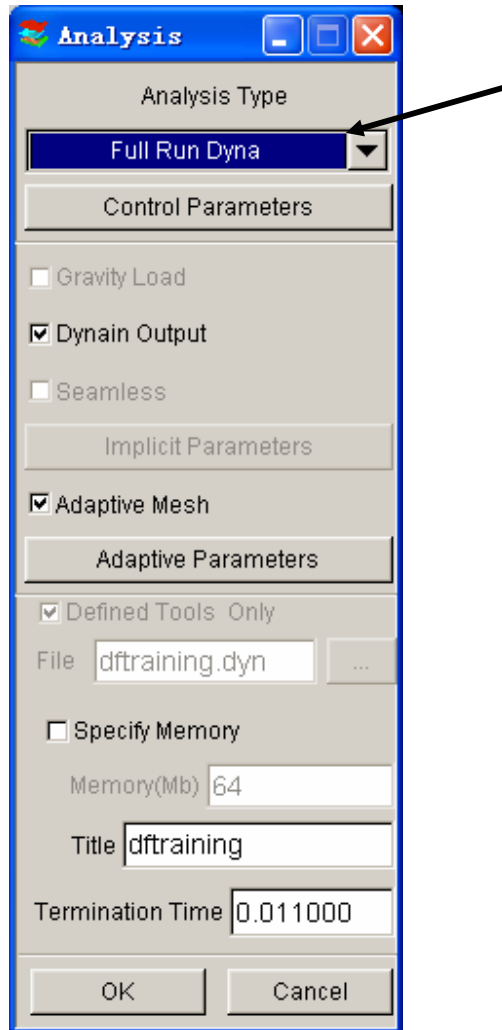

The solver displays a DOS window showing the status of the job. You will notice that an estimated completion time is given. This time is not accurate since we are using adaptive mesh and the model will re-mesh several times. Also, the number and speed of CPU influence it. However, it does give you a general idea.

Proceed to page 70 for post-processing after the program is completed.

```

D:\eta\SOLVER~1\lsdyna.exe
eroded kinetic energy..... 0.00000E+00
eroded internal energy..... 0.00000E+00
total energy..... 1.00000E-20
total energy / initial energy.. 1.00000E+00
energy ratio w/o eroded energy. 1.00000E+00
global x velocity..... 0.00000E+00
global y velocity..... 0.00000E+00
global z velocity..... 0.00000E+00

number of shell elements that
reached the minimum time step.. 0
cpu time per zone cycle..... 0 nanoseconds
average cpu time per zone cycle... 0 nanoseconds
average clock time per zone cycle.. 174593 nanoseconds

estimated total cpu time      =      0 sec <      0 hrs  0 mins>
estimated cpu time to complete =      0 sec <      0 hrs  0 mins>
estimated total clock time    =    2130 sec <      0 hrs 35 mins>
estimated clock time to complete =    2130 sec <      0 hrs 35 mins>

added mass      =  0.0000E+00
percentage increase =  0.0000E+00

1 t 0.0000E+00 dt 1.55E-06 flush i/o buffers
1 t 0.0000E+00 dt 1.55E-06 write d3plot file

```

3. Once the solver has given you the preliminary estimated time, you can refresh this estimate by pressing **Ctrl-C**. This will momentarily pause the solver which will prompt you to “**.enter sense switch:**”. Type the switch command you would like to use and press enter:

**sw1** – Terminates the Solver

**sw2** – Refreshes the Estimated Solving Time

**sw3** – Creates a d3dump Restart File

**sw4** – Creates a d3plot File

*Note:* These switches are case sensitive and must be all lower case when entered.

Enter **sw2** and press **Enter**. Notice the estimated time has changed. You can use these switches at anytime while the solver is running.

```
D:\eta\SOLVER~1\lsdyna.exe

input of data is completed

initialization completed
 896 t 1.1006E-03 dt 1.08E-06 write adaptivity stress file
 896 t 1.1006E-03 dt 1.08E-06 add shell elements from 2858 to 2891

memory needed for solution= 814165

input of data is completed

initialization completed
 989 t 1.1999E-03 dt 1.08E-06 write d3plot file
1151 t 1.3760E-03 dt 1.08E-06 write adaptivity stress file
1151 t 1.3760E-03 dt 1.08E-06 add shell elements from 2891 to 2912

memory needed for solution= 821408

input of data is completed

initialization completed

.enter sense switch:sw2
```

When you submit a job from eta/DYNAFORM, an input deck is created which the solver, LS-DYNA, uses to process the analysis. The default input deck names are **yourdatabasename.dyn** and **yourdatabasename.mod**. The **.dyn** file contains all of the control cards, and the **.mod** file contains the geometry data. Advanced users are encouraged to study the **.dyn** input file. For more information, refer to the **LS-DYNA User's Manual**.

Again, the eta/DYNAFORM Quick Setup interface is designed to help the user to quickly setup a standard draw simulation. The user is encouraged to learn the traditional, a more flexible way of setting up a draw simulation (Traditional Setup). Following the traditional setup procedure is a section on post processing the results, which is applicable to both types of setup.

# TRADITIONAL SETUP

Open the saved database as described in meshing section of this manual (on page 20). This file should contain the clean mesh data of the lower tool before it was separated for the QuickSetup procedure. If you do not have this database, repeat the procedure of MESHING.

## I. Offsetting the Lower Tool Mesh to Create the Upper Tool

1. Create a new part called **UPTOOL**. This part will hold the elements that we offset from the **LOWTOOL**. Click **Parts**→**Create** on **Menu bar**.
2. In the **New Part** dialogue, enter “**UPTOOL**” in the name field. Click **OK** and the part will be created.

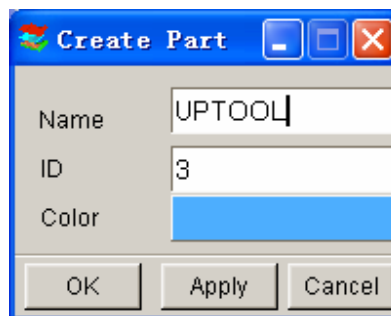

The part **UPTOOL** has been created and set as the current part automatically. We can now offset elements into this part. Turn on **LOWTOOL** and turn off **BLANK.LI**.

3. Select **Preprocess**→**Elements** on the **Menu bar**.

<u>L</u> ine/Point	Ctrl+L
S <u>u</u> rface	Ctrl+S
<u>E</u> lement	Ctrl+E
<u>N</u> ode	Ctrl+N
M <u>e</u> sh <u>R</u> epair	Ctrl+R
M <u>o</u> del C <u>h</u> eck	Ctrl+M
<u>B</u> oundary C <u>o</u> ndition	Ctrl+U
N <u>o</u> de/E <u>e</u> l <u>e</u> ment <u>S</u> et	Ctrl+V

4. Select the **Copy Elements** icon from the **Elements** dialogue.

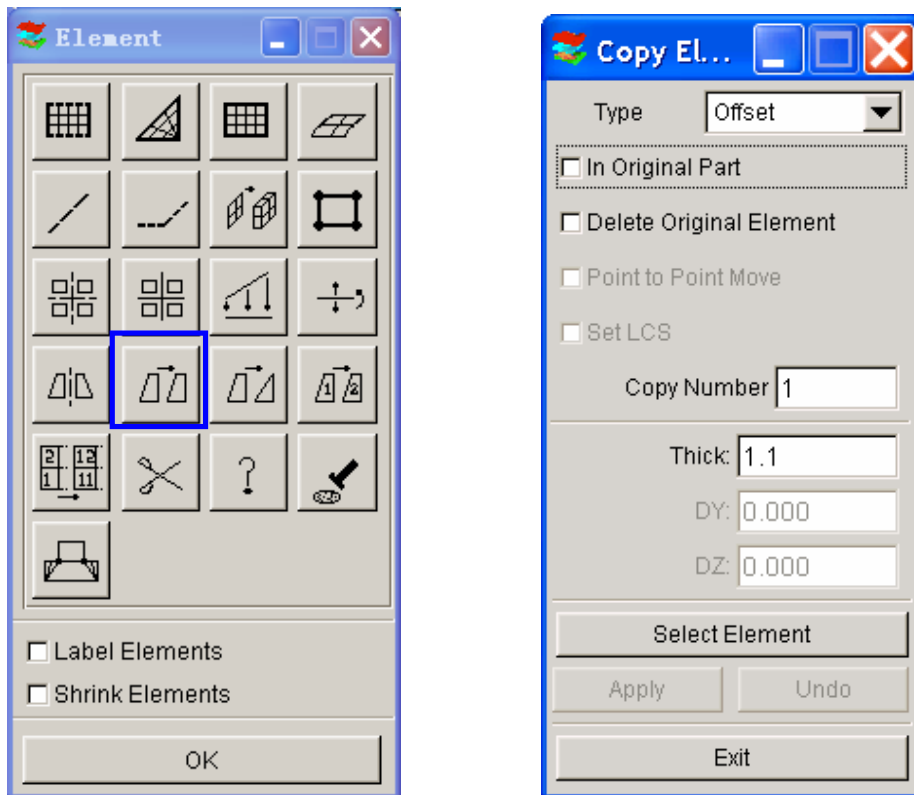

5. Click the drop-down menu to the right side where it says **Type**, and select **Offset**.
6. Toggle off **In Original Part** so that the offset elements will be put in the current part. Make sure **UPTOOL** is set as current. Toggle off **Delete Original Part**, the original part will be kept.
7. Enter **1** in the field where it says **Copy Number**, as the number of copies. Enter **1.1** in the field where it says **Thick**, as the offset thickness. In eta/DYNAFORM, the offset thickness is based on the material thickness of the blank plus 10% tolerance. Since we will be using a blank thickness of 1, enter 1.1 in the field.

**Note:** We use 10% of the thickness for simulation because when we do the post-processing, wrinkle data can be lost if there is not enough space between the punch and die after it has completed its travel path. If we use only the blank thickness as a gap, the punch will iron the blank flat, creating the impression that no wrinkling has occurred.

8. Click **Select Element** button.
9. **Select Elements** dialogue appears. Click the **Displayed** button, you will notice that the selected elements will turn white.

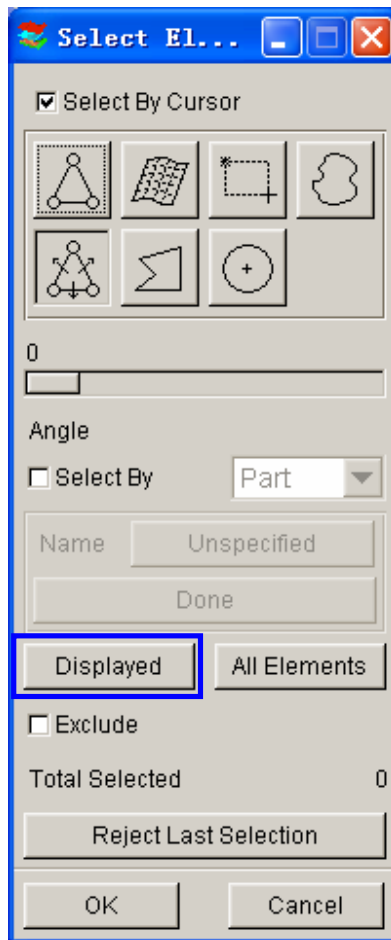

10. Click **OK** to accept the selected elements and return to the **Copy Elements** dialogue.
11. Click on **Apply**, all offset elements are placed into the part **UPTOOL**. Check your display by clicking the **Left View** icon.

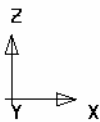
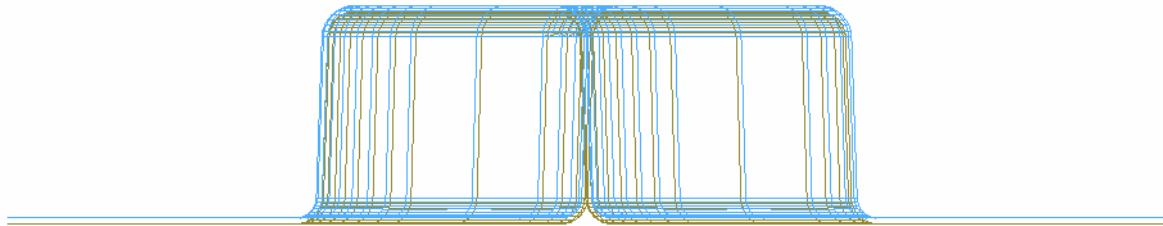

ETA/DYNAFORM

12. If your results differ, select **Undo**. Repeat the above steps to create mesh of **UPTOOL**.
13. Turn off the part **LOWTOOL** so that only **UPTOOL** is displayed. Switch to the isometric view.
14. Save the changes.

## II. Create the Lower Ring

Now we will separate the **Lower Ring** from the **LOWTOOL** and Move Elements on Run-out of **LOWTOOL** into **Lower Ring**.

1. Turn on **LOWTOOL** and turn off all other parts.
2. Create a new part called **LOWRING**. This part will hold the elements that we separate from the **LOWTOOL**. Click **Parts**⇒**Create** on **Menu bar**.
3. Enter **LOWRING** in the name field. Click **OK** and the part will be created.



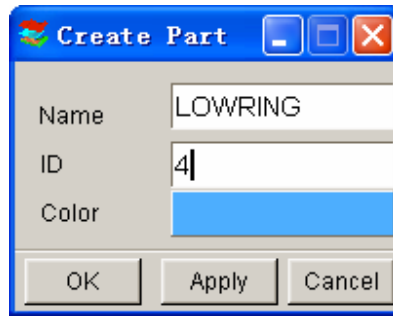

4. The part **LOWRING** has been created and set as the current part automatically. We can now place the lower ring elements in this part.
5. Click on **Parts** → **Add...To Part** from **Menu bar**.
6. The **Add...To Part** window appears as follows. Click the **Element(s)** button as shown below.

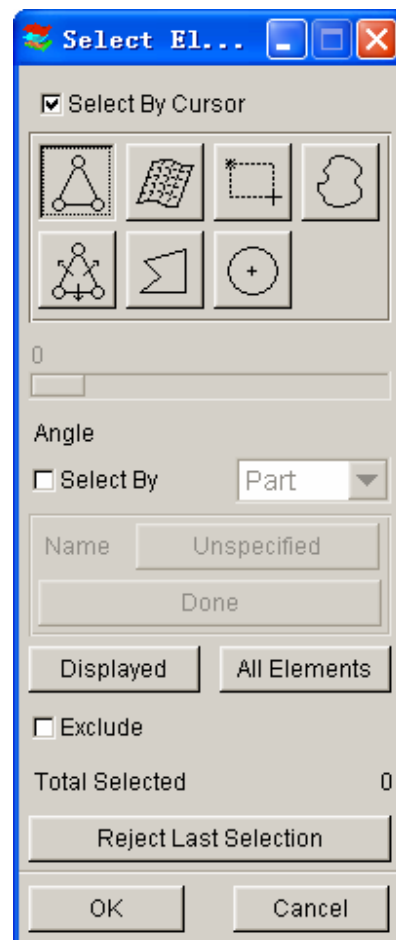
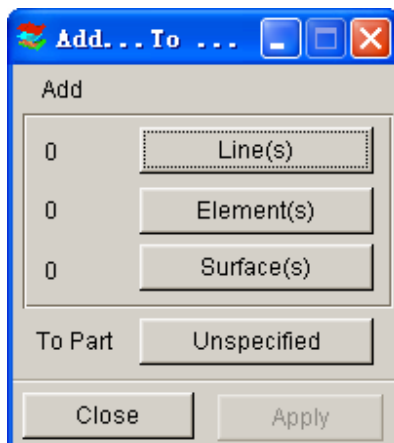

7. The **Select Elements** window appears (as shown above). The easiest way to select all elements of the ring is to switch the view to the **Top View (YX plane)**. Then, select the **Spread** icon. Click the slider and drag it to set an angle. Since the ring surface is flat, set a small angle, such as 1 degree.
8. Click any element on the right ring of **LOWTOOL**.
9. Click any element on the left-ring of **LOWTOOL**.

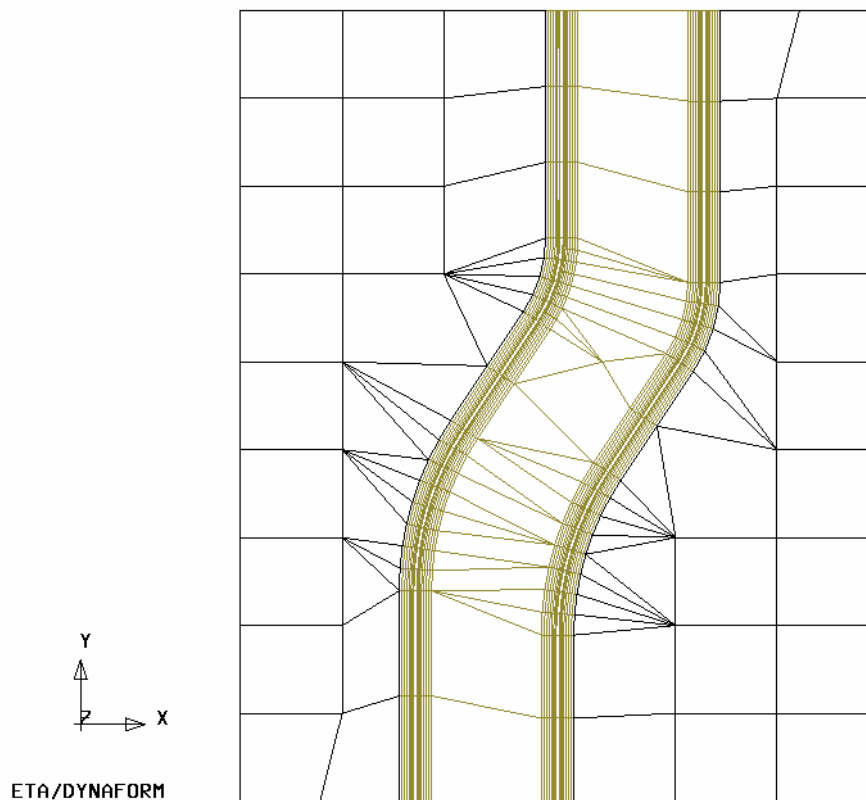

All elements in the flat area before an element angle change of larger than 1 degree should be highlighted. Compare your display to the preceding image. If your results differ, repeat the above steps.

10. Select **OK** on the **Select Elements** window. You will find the number of elements (67) is shown on the left side of the **Element(s)** button as below.
11. Select the **Unspecified** button.

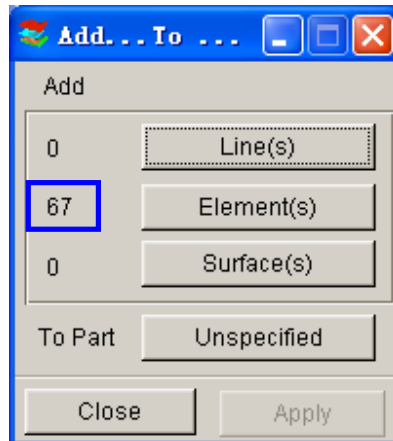

12. The **Select Part** window shows up. Select **LOWRING** in the **Select by Name** list. At this time, the **Unspecified** button will change to **LOWRING**.
13. Click **Apply**, all selected elements are moved into **LOWRING**.
14. Turn on only **LOWRING** and display the part using **Isometric view**, the resulting display should be as the following. If the result differs, please repeat the above steps.

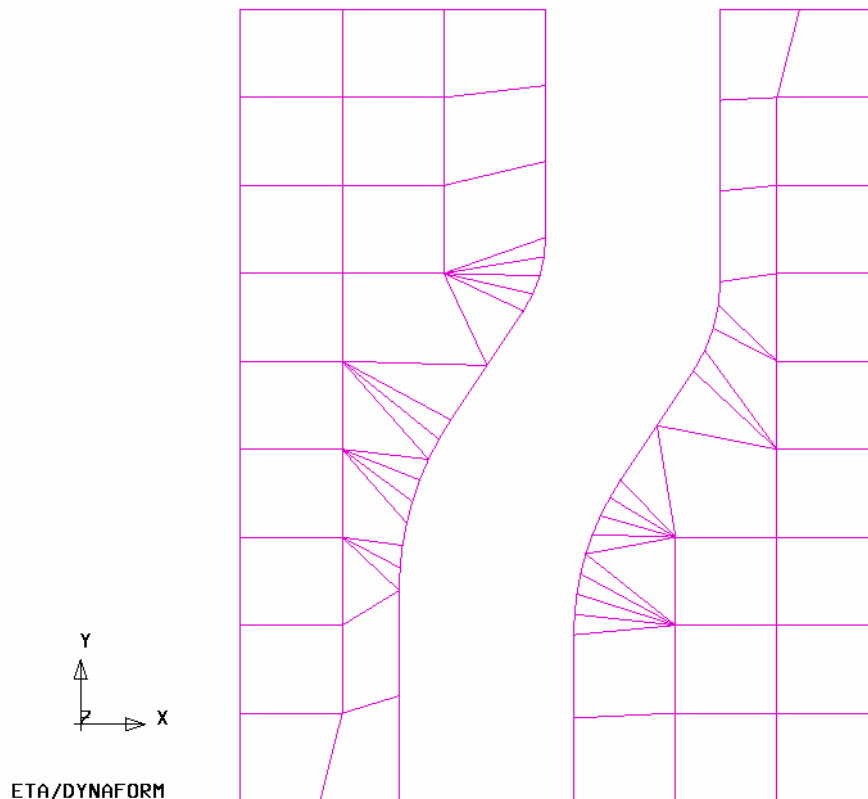

15. Save the database

### III. Separate LOWRING and LOWTOOL

Now **LOWRING** and **LOWTOOL** have two different groups of elements but they share common nodes along the boundaries. We need to separate them so that **LOWRING** and **LOWTOOL** can move independently.

Let's turn on **LOWRING** and **LOWTOOL** and turn off other parts.

1. Click **Parts**⇒**Separate** on the **Menu bar**.

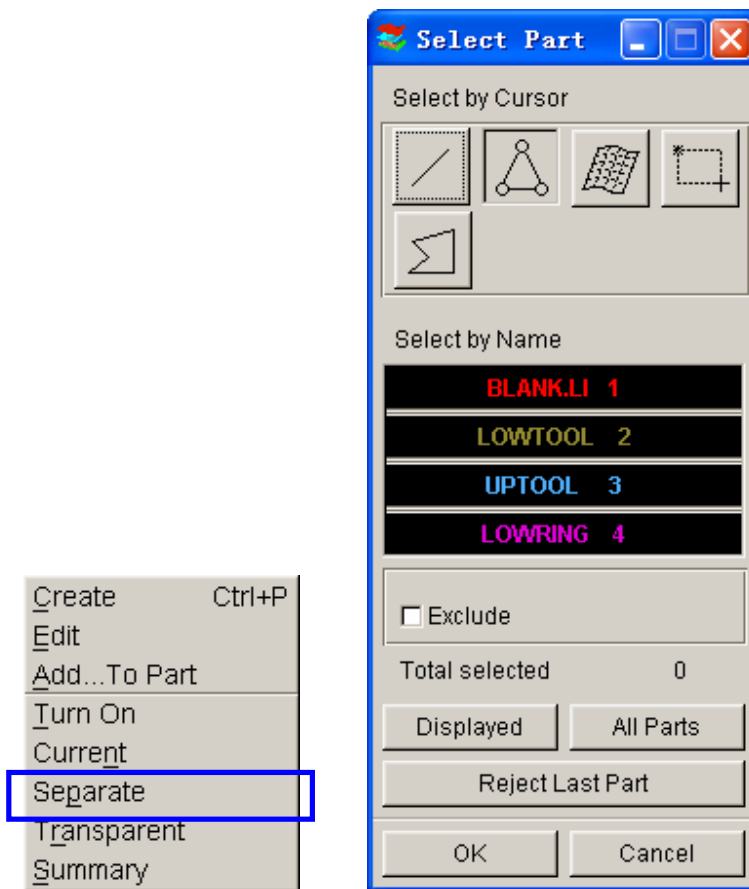

2. The **Select Part** window appears. Select **LOWTOOL** and **LOWRING** in the **Select by Name** list. Click **OK** to finish the function.

3. Save the changes.

## IV. Draw Type Setup

Prior to defining the tools, we first setup the draw type.

Click **Tools**⇒**Analysis Setup** from Menu bar. Select the Single Action as the **Draw Type**.

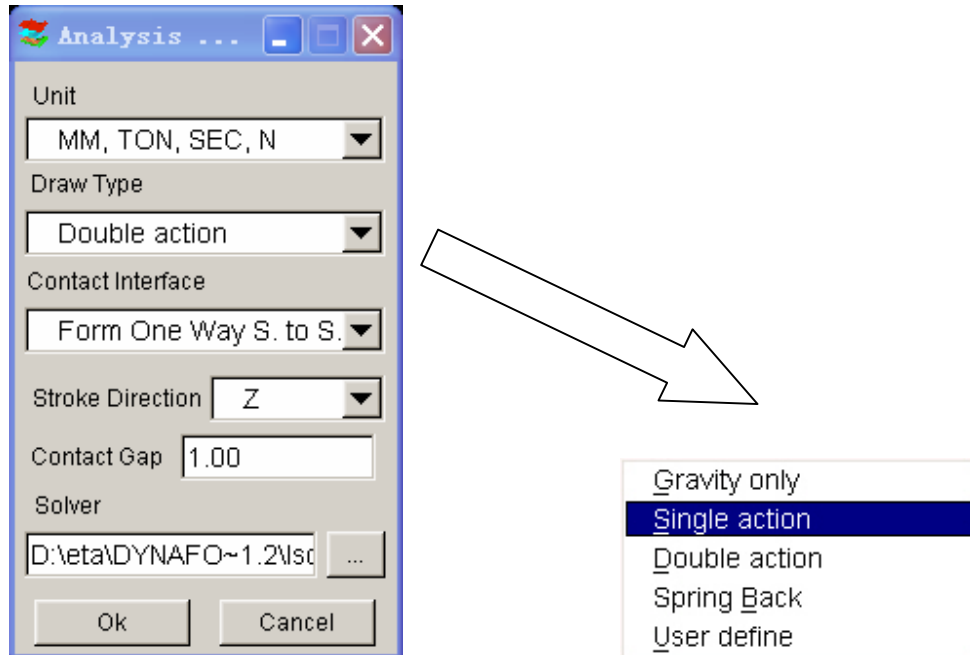

The **Draw Type** should correspond to the type of machine used to produce the actual work piece. This parameter defines the default moving direction of the punch and binders. If you are not sure, or are performing a new process, you should select **User Defined**. You can also refer to the **eta/DYNAFORM User's Manual** for information on the **draw type**.

## V. Tool Definition

### Defining Parts as Tools

The parts **BLANK.LI**, **LOWTOOL**, **UPTOOL**, and **LOWRING** are all meshed and can now be defined as tools.

1. Select **Tools**⇒**Define Tools** on **Menu bar**.

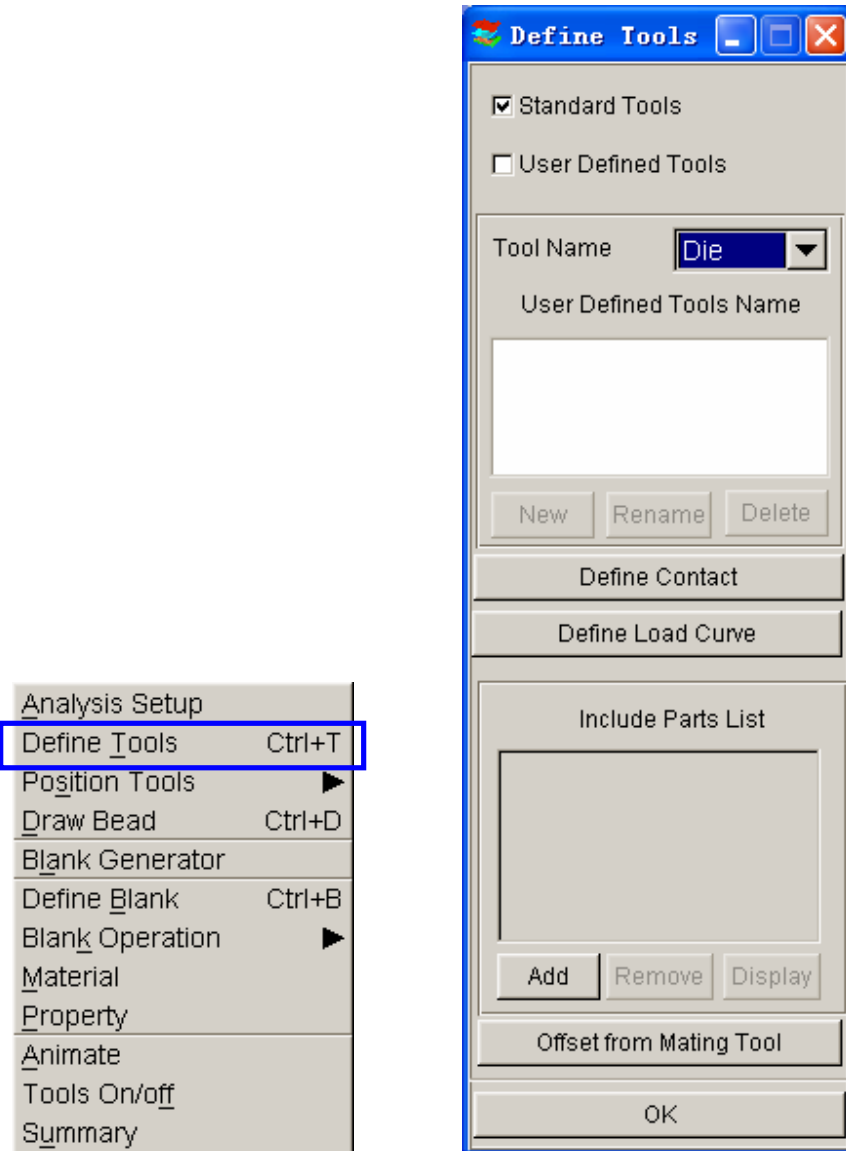

2. In the **Define Tools** dialogue, select **DIE** from the **Tool Name** menu as below.
3. Select **ADD**.
4. The **Select Part** dialogue will be displayed, prompting you to select which part will be defined as the DIE. Choose **UPTOOL** from the **Select by Name list** and then click **OK**.
5. Return to the **Define Tools** dialogue. You will find the **UPTOOL** is placed in the **Include Parts List**.

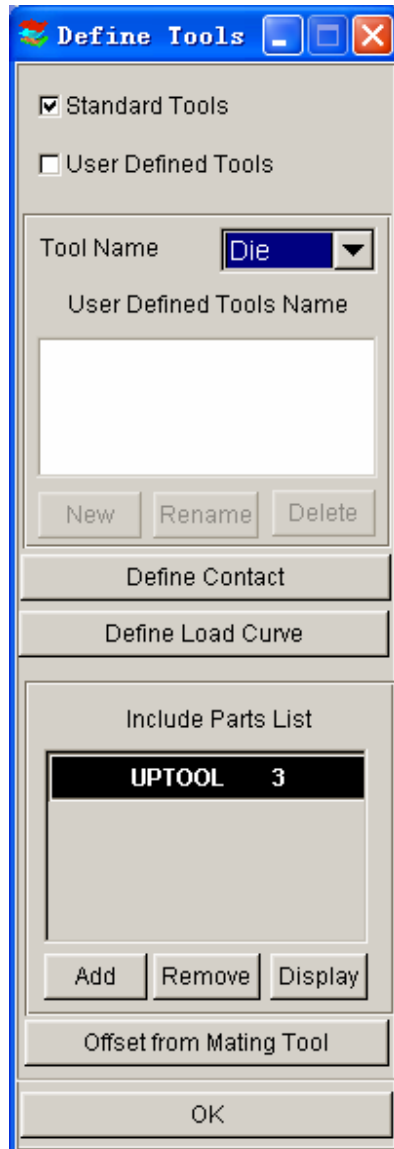

- Repeat the above steps to define the Punch (**LOWTOOL**) and Binder (**LOWRING**). Remember to select the correct Tool Name in Step 2.
- Once you have all of the tools defined, click **OK** on the bottom of **Define Tools** dialogue to finish this step. Save the changes.

## VI. Defining the Blank and Setting up Processing Parameters

### Define the Blank

1. Select **Tools**→**Define Blank** on the Menu bar.

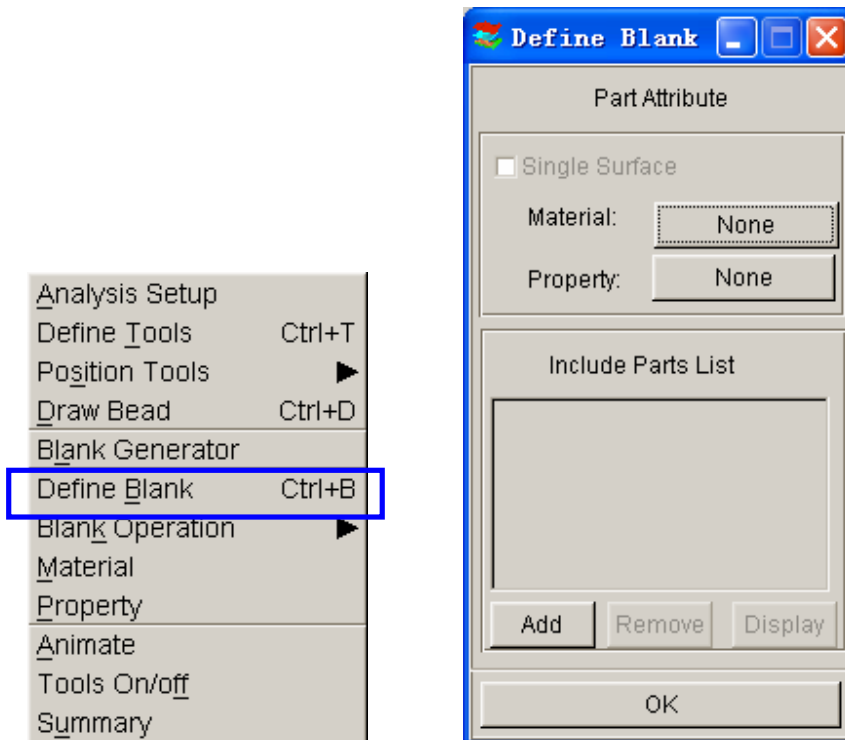

2. Click the **Add** button in the **Define Blank** dialogue.
3. The **Select Parts** dialogue is displayed. Select **BLANK.LI** from the **Select by Name** list.
4. Click **OK**. The **BLANK.LI** is added in the **Include Part List** as shown below.

### Define the Blank Material

1. The **Define Blank** dialogue should still be opened, click the button located right next to “**material:**”



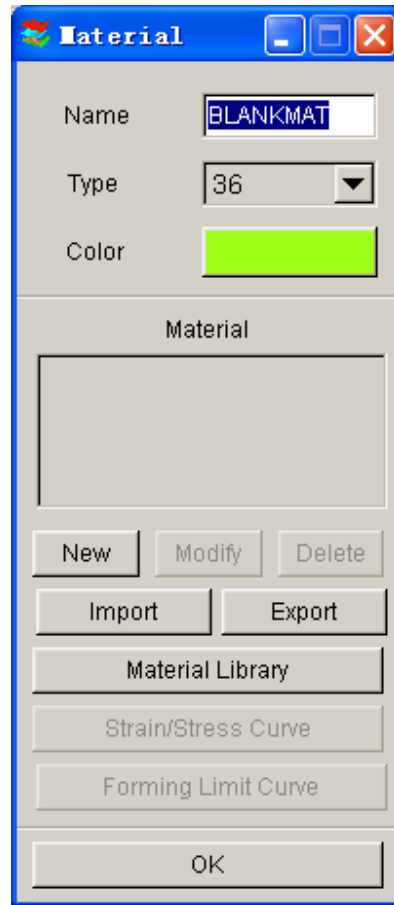
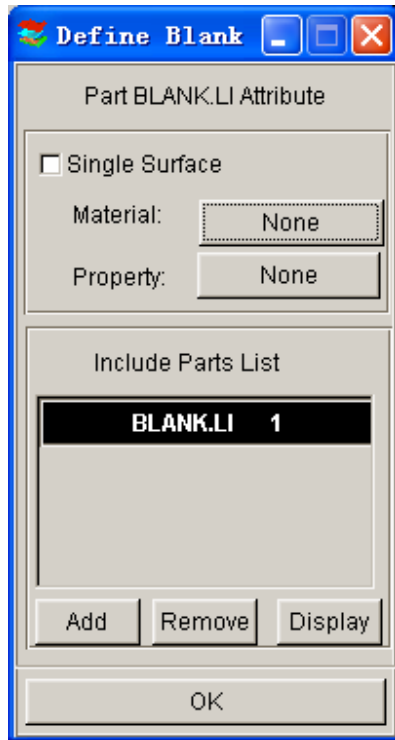

2. Select **Material Library**. A list of materials will be shown as in the illustration below. In this dialogue, select the **mild steel “DQSK”** under material type 36 (**Note:** material type 36 and 37 are recommended for most simulations).

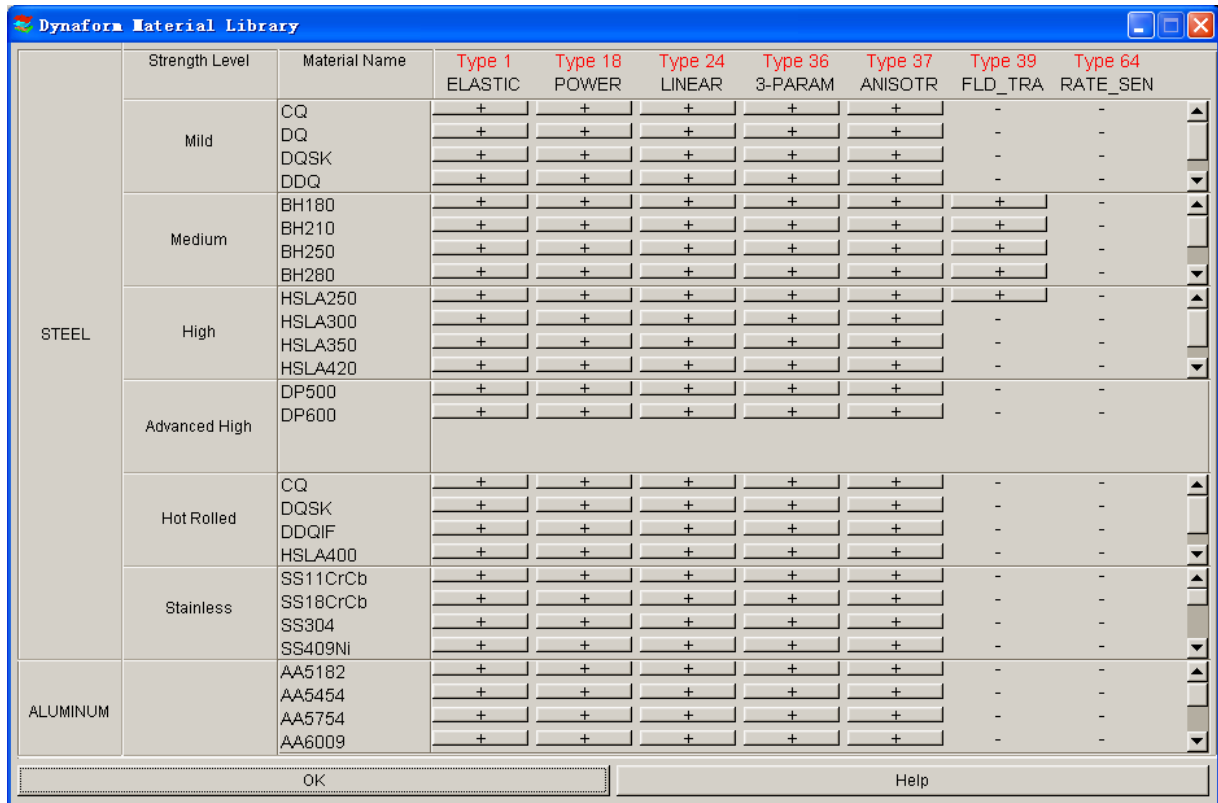

3. Select **OK** to use the default material parameters (following image) for the DQSK material model (**Note:** ETA makes no guarantees as to the validity and/or accuracy of the generic material models from the material library. Users should contact their material suppliers to determine proper material parameters).

### Define Blank Property

1. The **Define Blank** dialogue should still be open, click the button just right of where it says **Property:** (This button will say **None** because the property has not been defined yet).

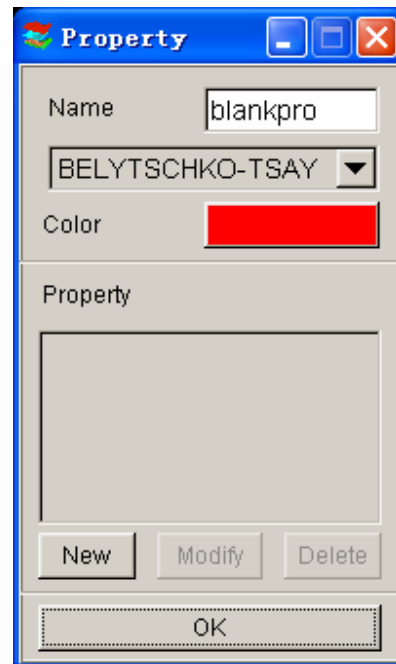
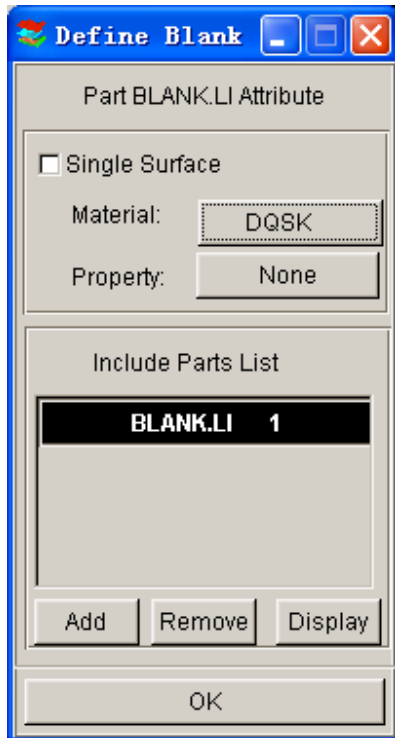

2. In the **Property** dialogue, enter a name for the material, For example put “blankpro” for material property. (If there is a default property name exists, user can skip the typing). Be sure to select type **BELYTSCHKO-TSAY** (default) and select any color from **Color** dialogue. Click **New**.
3. The **BELYTSCHKO-TSAY Property** card will be displayed. In this dialogue, you can edit the thickness of the material. To edit a field, left click on the field and change the value in the **Current Value** dialogue. Make sure **UNIFORM THICKNESS** is 1.000. Leave all other fields at their default values and select **OK**.

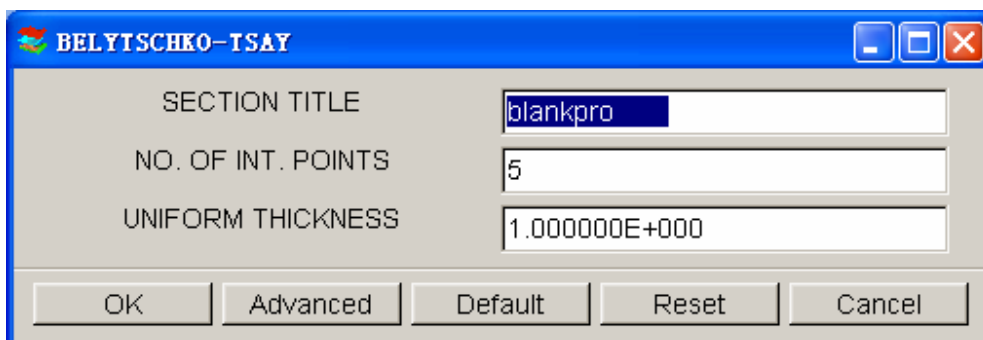

4. eta/DYNAFORM returns to the **Property** dialogue. Click **OK**.
5. Select **OK** to finish defining the Blank, Material and Property.

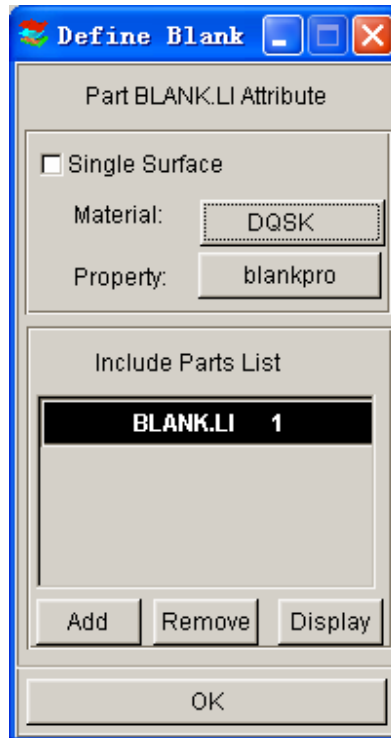

## VII. Tools Summary

1. Verify that all of the needed tools are defined by selecting the **Tools Summary** function in the **Tools** menu.
2. After you have verified the tooling definition, click **OK**. Save the changes.



## VIII. Auto Positioning the Tools

Now that all of the tools have been defined, we need to place them in the correct position by doing the following:

1. Turn on all of the parts in the database and select the **isometric view**.
2. Click **Tools**⇒**Position Tools**⇒**Auto Position** on the **Menu bar**.

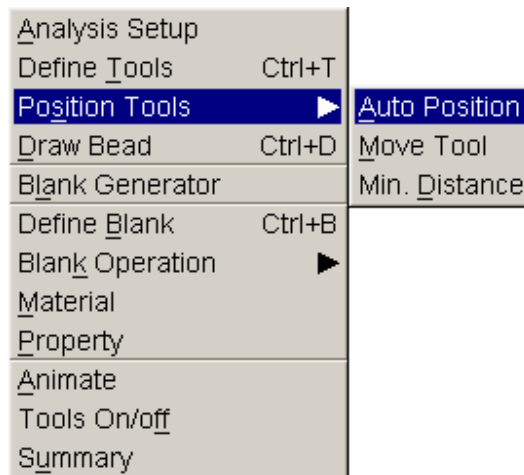

3. The **Auto Position Tools** dialogue will be displayed. In this dialogue, define the Master and Slave Tools. The Master Tool is the tool that will not move while you Auto Position; it should be the Blank. Select **BLANK** in the **Select Master Tool** dialogue and then select the remaining tools in the **Select Slave Tools** dialogue. (For the PC version, the user needs to hold down the control key to select all three slave tools).

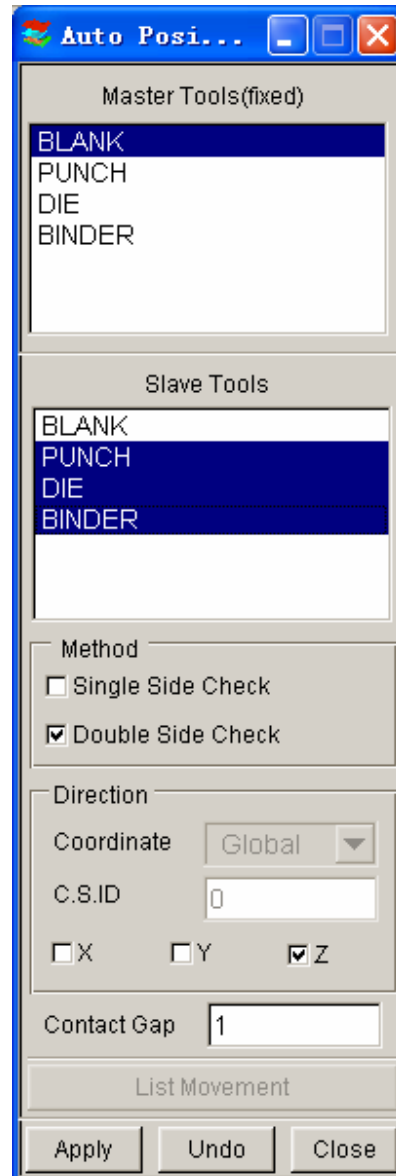
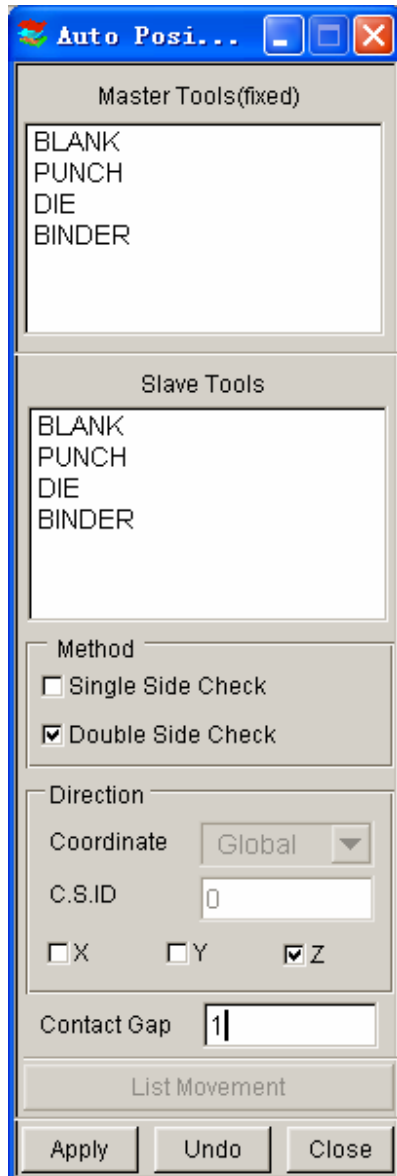

Once the correct Master and Slave Tools are selected, be sure that **Z** (direction) is selected as the moving direction and enter a **Contact Gap** of **1**. The gap value should be the Blank Thickness to avoid initial penetration. Press **Apply** and the tools will be automatically positioned.

4. Compare your display with the following image.

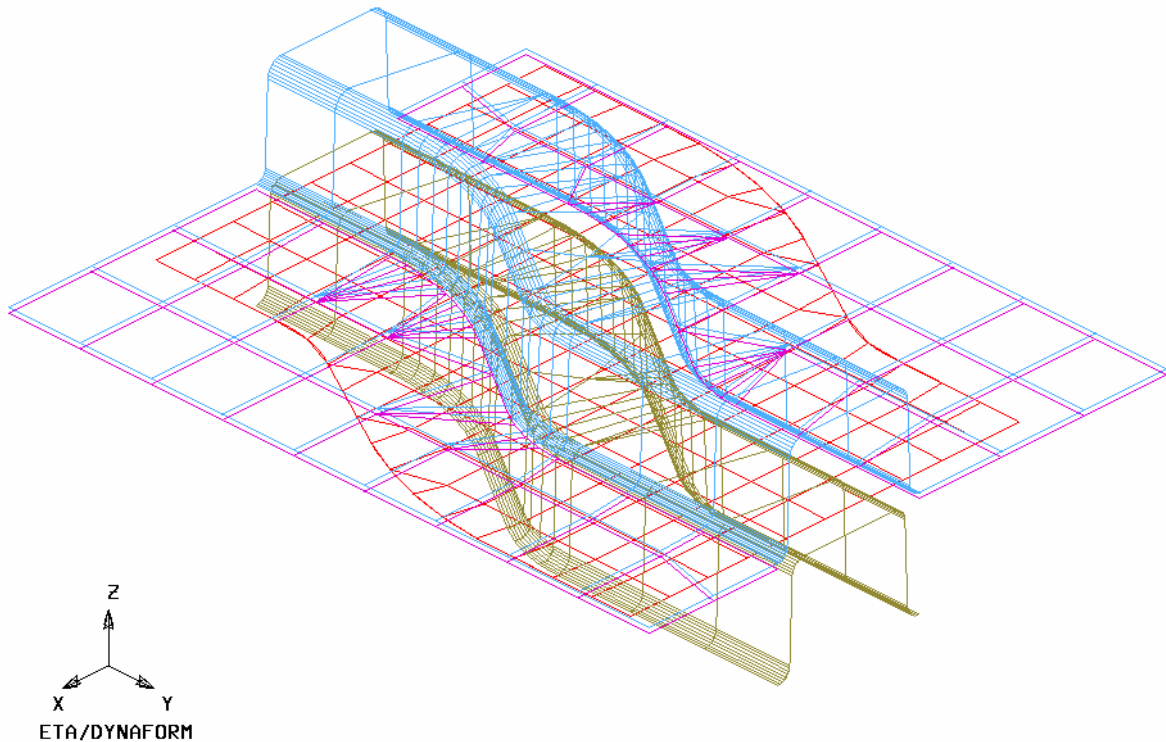

5. If your result differs, select **UNDO** to repeat the above steps and make sure the result is correct. If the position is wrong, check **Tools/Analysis Setup**, make sure the “Draw type” is set to inverted.
6. Select **CLOSE** to exit the auto position menu.
7. Save the changes.

## **IX. Measuring the DIE Travel Distance**

Now that the parts have been meshed and defined as tools, we can setup the motion curves. The first step is to find the travel distance of the tools.

1. Click **Tools**➔**Position Tools**➔**Min Distance** on **Menu bar**.

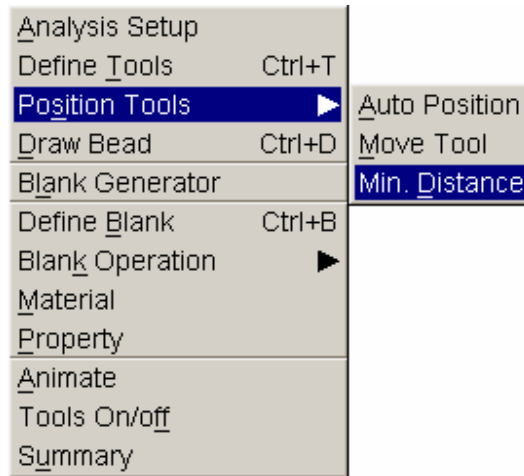

2. The **Min. Distance** dialogue will be displayed. Select **Z** (direction) as the direction to measure in, then highlight the **DIE**, following by the **PUNCH**. This will allow user to measure the distance, in the Z-direction, between the Punch and the Die, and display it in the **Distance** dialogue.

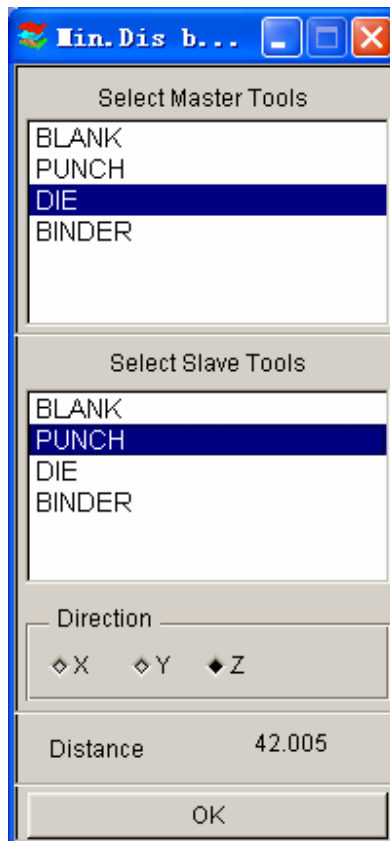



3. The total distance between the Punch and the Die is approximately 42. To find the Punch travel distance, subtract the offset thickness (blank thickness + 10%). We will obtain a Punch travel distance of approximately 40.9. Take note of the number you calculated.
4. Select **OK** located at the bottom of the **Min. Distance** dialogue, and end this step.

The automatic distance measurement is reliable for flat binders. For more complicated binder shapes, the user should measure the travel distance using the distance measurement tool between nodes found under the Utilities menu.

## **X. Define DIE Velocity Curve**

1. Click **Tools**→**Define Tools** on the **Menu bar**.
2. Select Die from the **Tool Name** list and then select the **Define Load Curve** button.

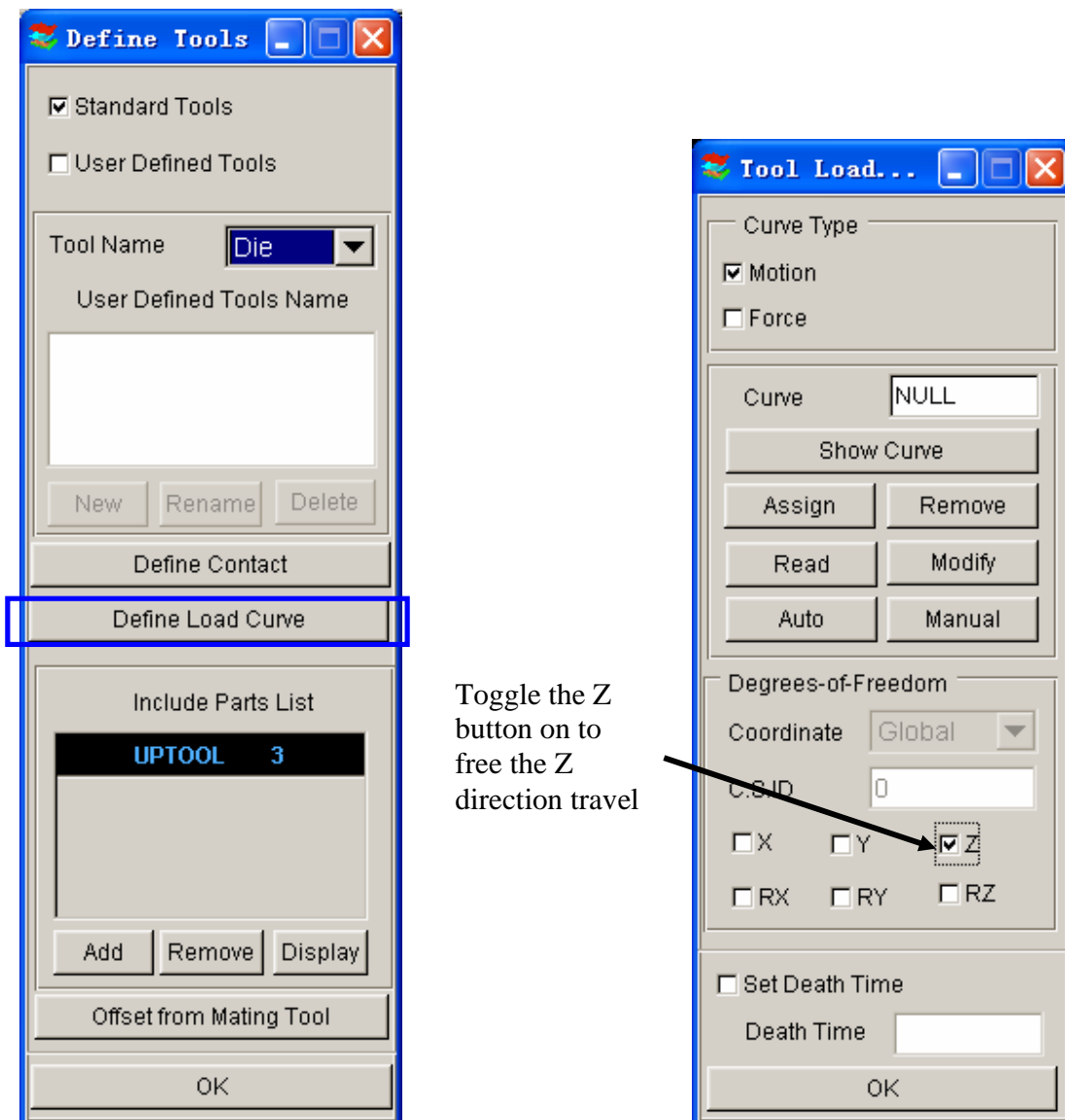

Toggle the Z button on to free the Z direction travel

3. Click on **Auto**. Make sure the **Z** is selected as the Degrees-of-Freedom to define the moving direction. Use the default curve type (**Motion**) (see the following illustration).
4. Choose Velocity as the default **Curve Type** (see illustration below) and default **Curve Shape** as **Trapezoidal**. Keep the beginning time of 0.000E+000. In the **Velocity** field, enter 8000 (mm/s). For the **Stroke Dist.**, use the value that we found after measuring the Punch travel distance and subtracting the Blank thickness. The value should be approximately 40.9. After entering the values, click **Yes** and a new Velocity vs. Distance motion curve will be created and displayed (as shown in the following illustration).

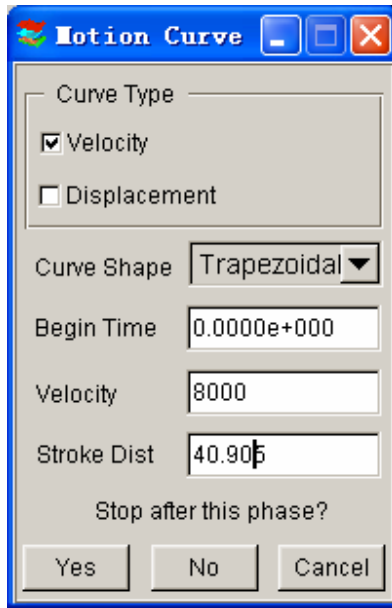

5. Verify that the load curve is identical to the graph as shown on next page.

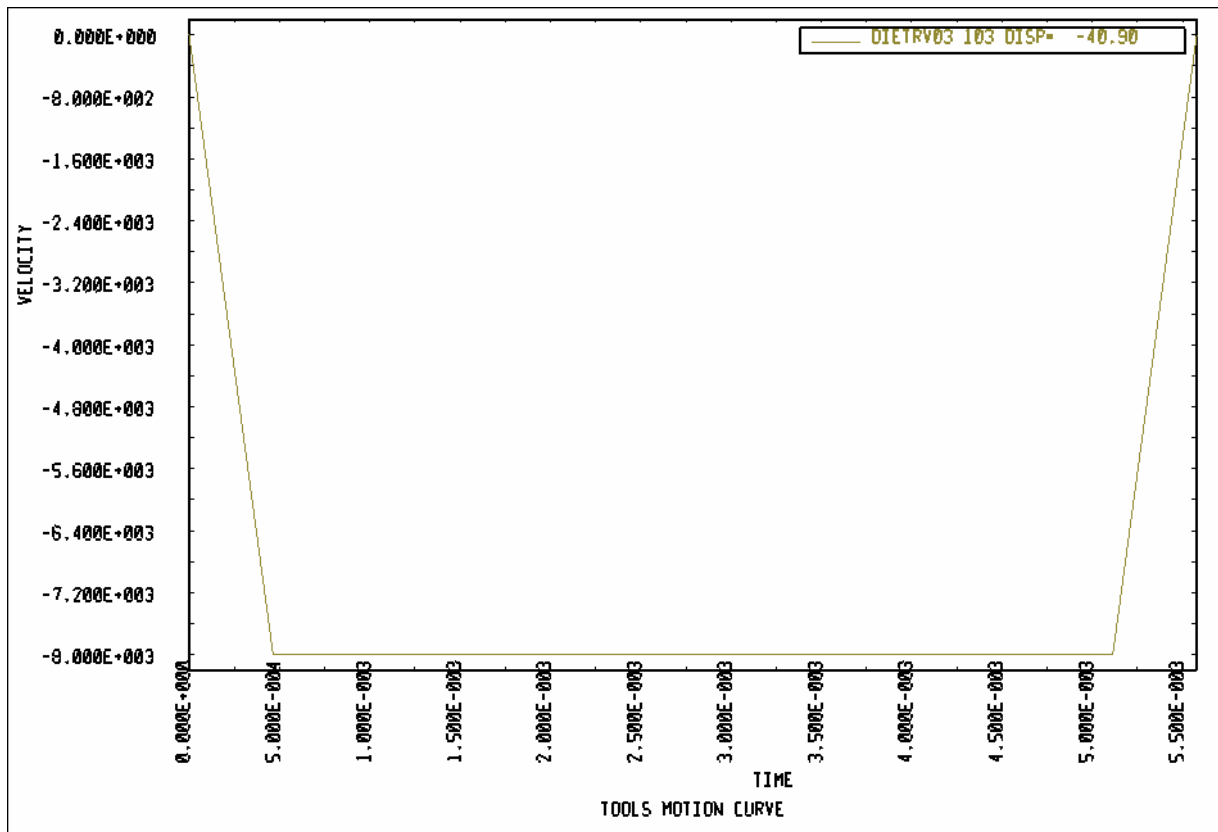

6. Select **Ok** in the **Curves** dialogue to return to the **Tool Load Curve** dialogue. From here, click **Ok** once more to return to the **Define Tools** dialogue. Do not close this dialogue, the next step will start from here.

## XI. Defining the Binder (LOWRING) Force Curve

As the Punch travel curve has been created, we can create the force curve for the Lower Ring.

1. From the **Define Tools** dialogue, select **Binder** from the **Tool Name** menu and select the **Define Load Curve** button.

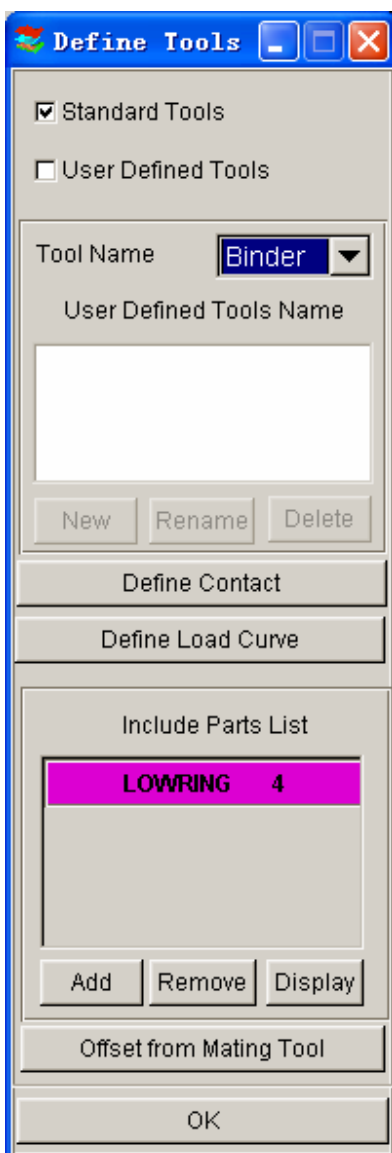

2. Select **Curve Type (Force)**. Make sure to select **Z** to define the moving direction and then click **Auto** button.
3. Enter 200000 (N) in the **FORCE** and close the window by clicking **OK**.

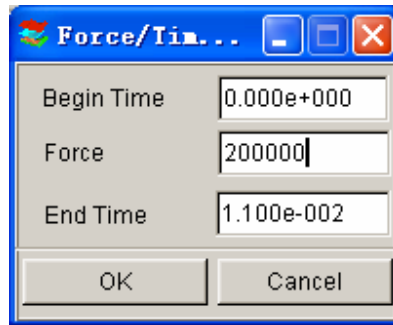

4. The **Lower Ring force** curve will be displayed. Verify that it is identical to the curve shown on next page.

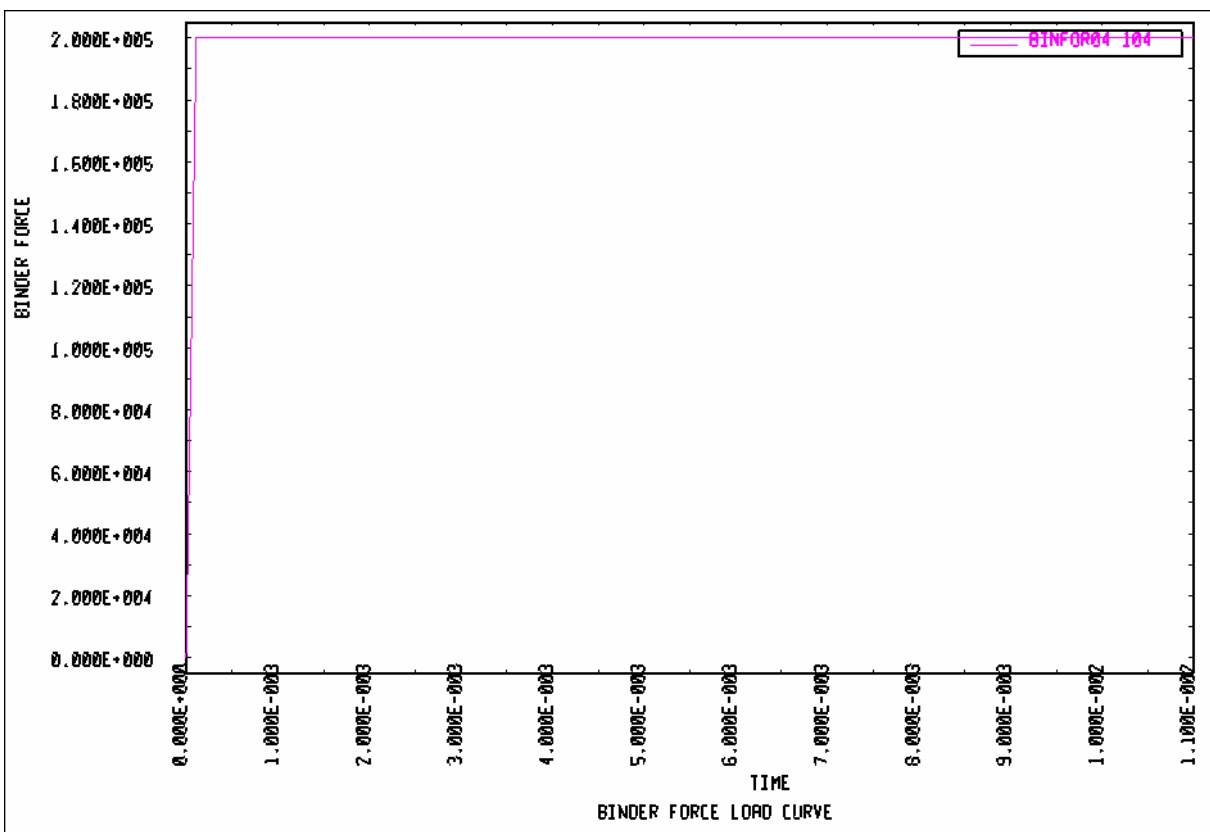

5. Select **OK** in the **Curves** dialogue to return to the **Tool Load Curve** dialogue. From here, select **OK** once more to return to the **Define Tools** dialogue.

6. Click **OK** in the **Define Tools** dialogue; we are done defining the motion curves for the tools.

7. Save the changes.

## XII. Preview Tool Animation

We have now completed all of the pre-processing outside of setting up the final simulation parameters and submitting the job. Before we can do that however, we should verify that the tools are moving correctly, based on the motion curve information we have assigned.

1. Click **Tools**⇒**Animate** on **Menu bar**.

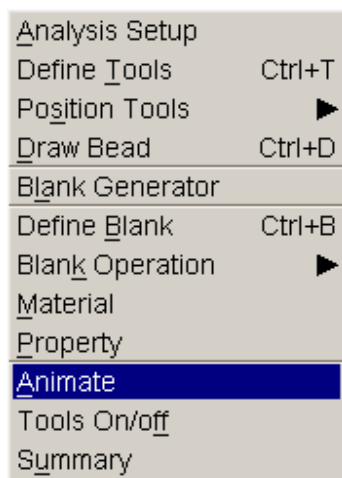

2. Click **Play** to animate the tooling using the default parameters.

***Note:** Depending on the speed of the machine that is used to run eta/DYNAFORM, the animation might move too quickly. If this is the case, enter a larger number of frames.*

3. You can change the view while running the preview animation. Verify that the Punch is moving in the Z-direction, and make sure it is moving the full distance into the Die. Since we are using a force curve for the Binder, you will not see it move. Also, notice the **Individual Frames** switch on the dialogue. After viewing the animation, click the **Stop** button on the **Animate** dialogue to exit the function.

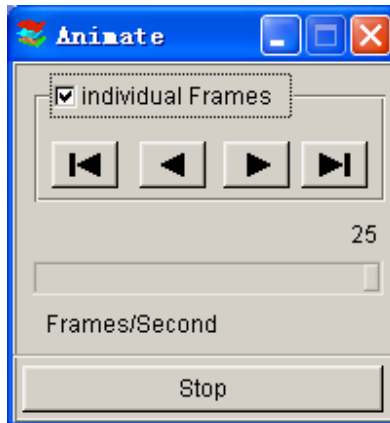

4. Save the database.

### **XIII. Running the Analysis**

After verifying that the tool motion is correct, we can define the final parameters and run the analysis.

#### **Running the Analysis with Adaptive Mesh**

Adaptive mesh allows the user to obtain more accurate results by refining the blank mesh as needed during the simulation. In other words, as the die deforms the blank, areas that demand a finer mesh to capture the tooling geometry will divide to create finer and smaller elements.

1. Select **Analysis**→**LS-DYNA...** from the **Menu Bar**.

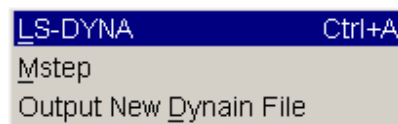

2. Click the **Control Parameters** button in the **Analysis Parameters** dialogue.
3. As a new user, it is recommended to use the default control parameters (for more information on them, please refer to the *LS-DYNA User's Manual*). Click **OK**.

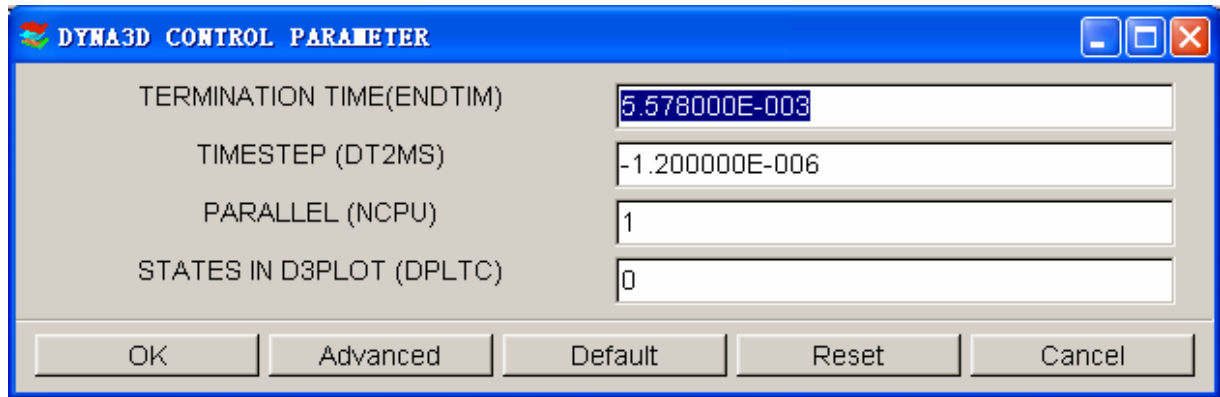

4. There are two methods to run the job.

1. Select **Full Run Dyna** and press **OK**. The solver will now be running in the background.
2. For manual submission of the input deck:
  - a. Select **LS-Dyna Input File** and enter a file name (e.g. training) and press **Ok**.
  - b. Find the directory that includes your current example file (training.df), you will find two files “training.dyn” and “training.mod”. All files generated by either eta/DYNAFORM or LS-DYNA will be placed in the directory in which the eta/DYNAFORM database has been saved. This includes all input decks and post processing files.
  - c. Then select **File->Submit Dyna from Input Deck**, find the “training.dyn”, then press **OK**.
  - d. Give a right memory, press **OK** to start the solver.

The solver displays a DOS window showing the status of the job. You will notice that an estimated completion time is given. This time is not accurate since we are using adaptive mesh and the model will re-mesh several times. Also, it is influenced the speed and number of CPU of the machine. However, it does give you a general idea.

5. Once the solver has given you the preliminary estimated time, you can refresh this estimate by pressing **Ctrl-C**. This will momentarily pause the solver which will prompt you to “**.enter sense switch:**”. Type the switch command you would like to use and press enter:

**sw1** – Terminates the Solver

**sw2** – Refreshes the Estimated Solving Time

**sw3** – Creates a d3dump Restart File

**sw4** – Creates a d3plot File

***Note:** These switches are case sensitive and must be all lower case when entered.*



Enter **sw2** and press **Enter**. Notice the estimated time has changed. You can use these switches at anytime while the solver is running.

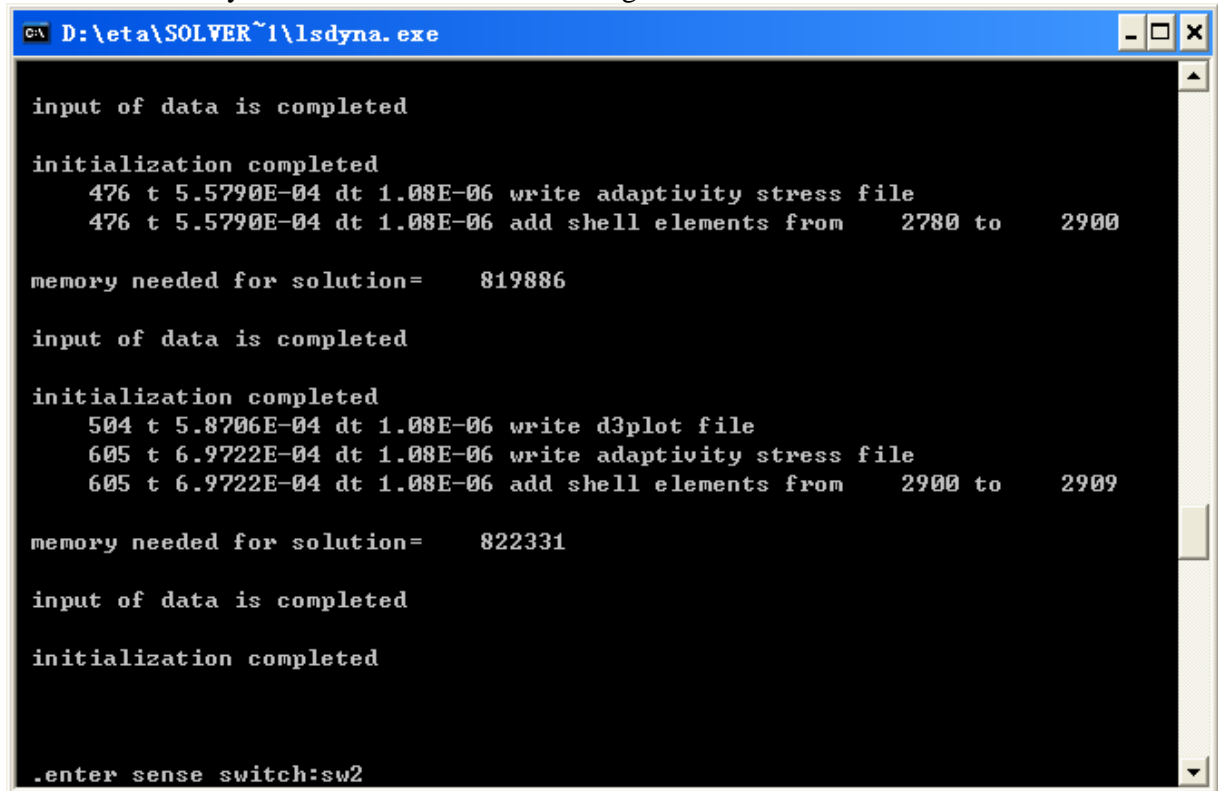

```
D:\eta\SOLVER~1\lsdyna.exe

input of data is completed

initialization completed
  476 t 5.5790E-04 dt 1.08E-06 write adaptivity stress file
  476 t 5.5790E-04 dt 1.08E-06 add shell elements from 2780 to 2900

memory needed for solution= 819886

input of data is completed

initialization completed
  504 t 5.8706E-04 dt 1.08E-06 write d3plot file
  605 t 6.9722E-04 dt 1.08E-06 write adaptivity stress file
  605 t 6.9722E-04 dt 1.08E-06 add shell elements from 2900 to 2909

memory needed for solution= 822331

input of data is completed

initialization completed

.enter sense switch:sw2
```

When you submit a job from eta/DYNAFORM, an input deck is created which the solver, LS-DYNA, uses to process the analysis. The default input deck names are **yourdatabase name.dyn** and **yourdatabasename.mod**. The **.dyn** file contains all of the control cards, and the **.mod** file contains the geometry data. Advanced users are encouraged to study the **.dyn** input file. For more information, refer to the *LS-DYNA User's Manual*).

**Note:** All files generated by either eta/DYNAFORM or LS-DYNA will be placed in the directory in which the eta/DYNAFORM database has been saved. It is necessary to make sure the fold doesn't include other resultant files before running the current job in case part of files are overwritten.

# POST PROCESSING (with eta/POST)

The eta/POST reads and processes all the available data in the **d3plot** file. In addition to the undeformed model data, the **d3plot** file also contains all result data generated by LS-DYNA (stress, strain, time history data, deformation, etc.).

## I. Reading the Results File into the Post Processor

To execute eta/POST, click **PostProcess** from eta/DYNAFORM menu bar. The default path for eta/POST is C:\Program Files\Dynaform 5.2. In this directory, double click the executable file, **EtaPostProcessor.exe**. The eta/POST can also be accessed from the programs listing under the start menu under **DYNAFORM 5.2**.

The eta/DYNAFORM Menu Bar

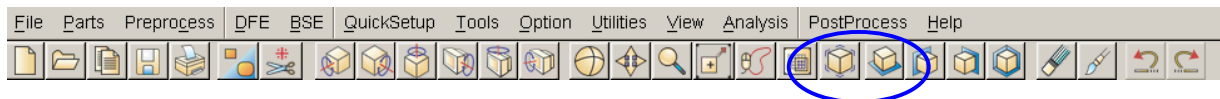

The eta/POST GUI

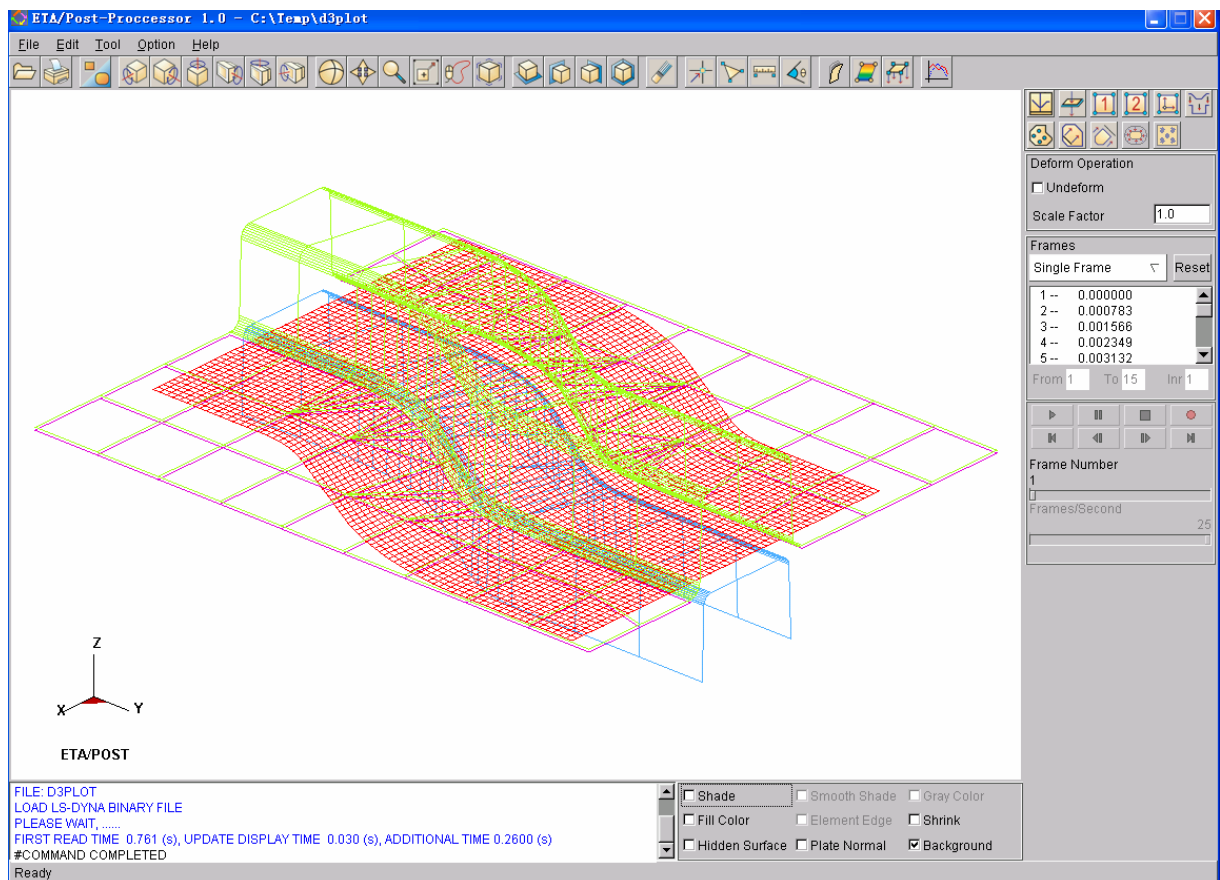

1. From the **File** menu of **eta/POST**, select **Open**. The Open File dialogue will be displayed.

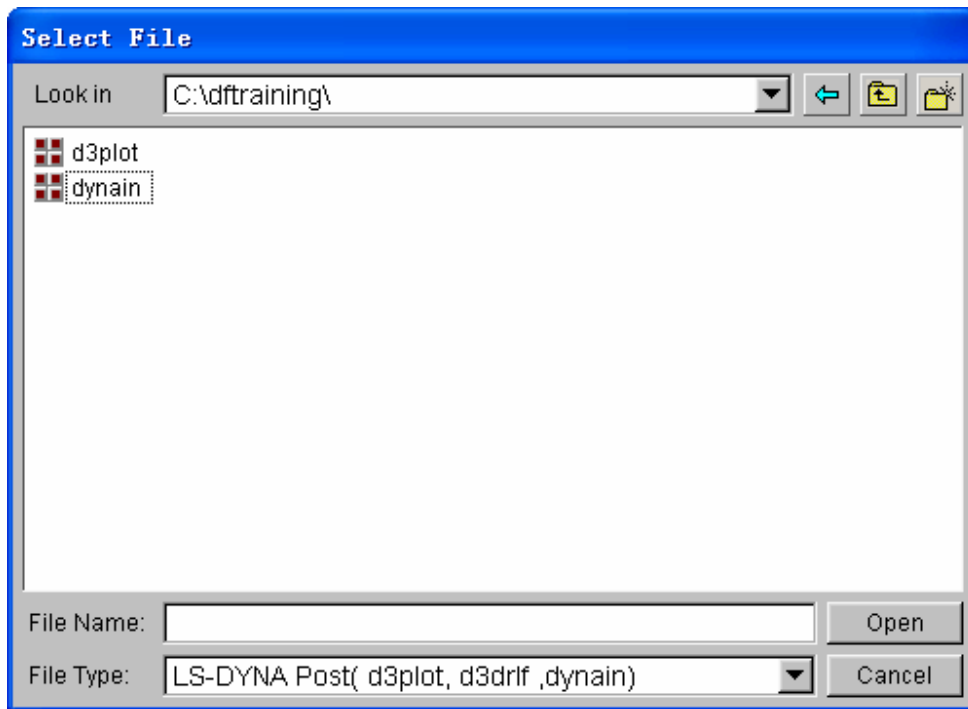
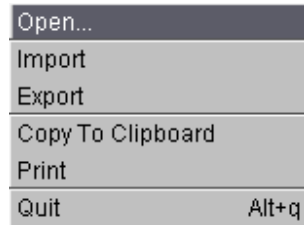

2. Select **LS-DYNA Post (d3plot, d3drif, dynain)** from the **Files of Type** list. This option will allow you to read in the **d3plot, d3drif or dynain** file. The **d3plot** is output from forming simulation (drawing, binder wrap and springback), while **d3drif** is generated during gravity loading simulation, the **dynain** is generated at the end of simulation and put the deformed blank information.

After moving to the directory where you saved the result files, be sure you have the correct file of type selected, pick the **d3plot** file, and press **Open**.

3. The d3plot file is now completely read in. You are ready to process the results using the result manipulation menu bar as shown below.



## II. Animating Deformation

1. The default **Plot State** is **Deformation**. In the **Frame** dialogue, select **All Frames** and then press **Play** button to animate the results.

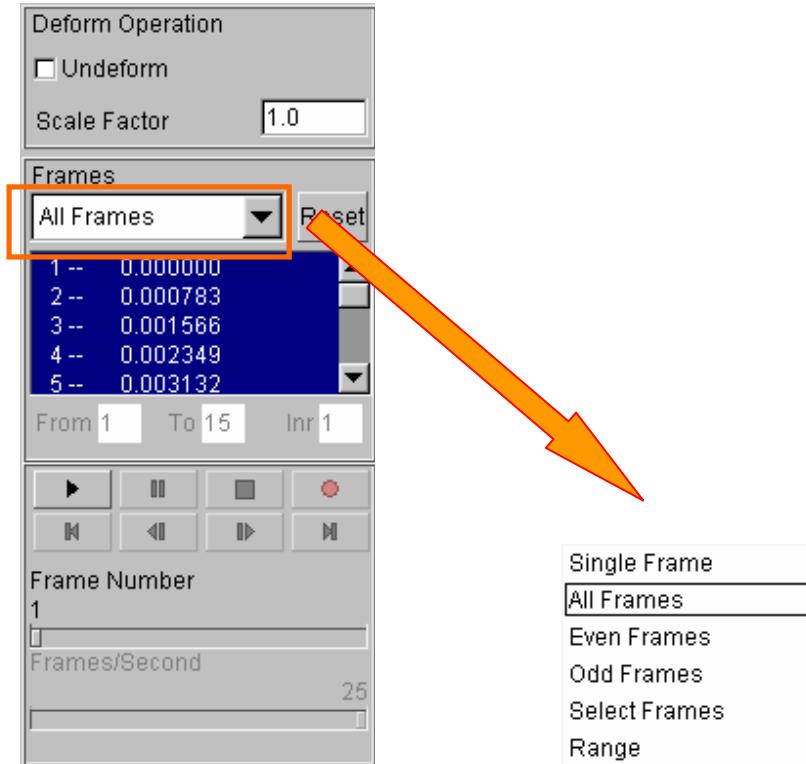

2. Toggle on the **Shade** check box near the bottom right of the screen to shade the model. The user can toggle on **Smooth Shade** to display a smooth model.

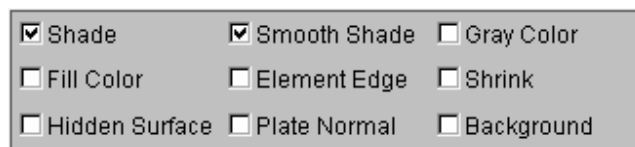

3. Since it is difficult to see the Blank with all of the other tools displayed, you can turn them all off, except for the Blank. From **Toolbar** menu, select **Part on/off** button.



4. In Part Operation dialogue, turn off all of the parts except for the Blank and press **Exit**.

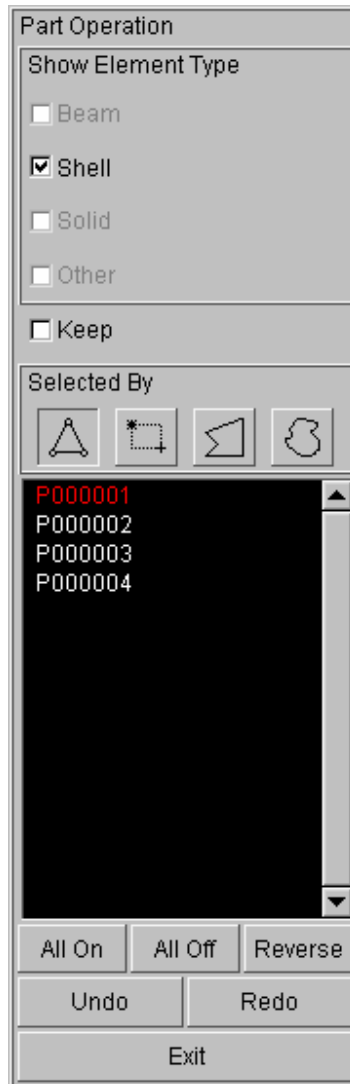

5. You can also change the view with the view manipulation icons on the tool bar, just as we did in the pre-processor.



**View Manipulation**

### III. Animating Deformation, Thickness and FLD

eta/POST can animate deformation, thickness, FLD and various strain/stress distribution of the blank. To do this, refer to the following examples.

## Deformation

The deformation in result manipulation menu bar is set as the default display.

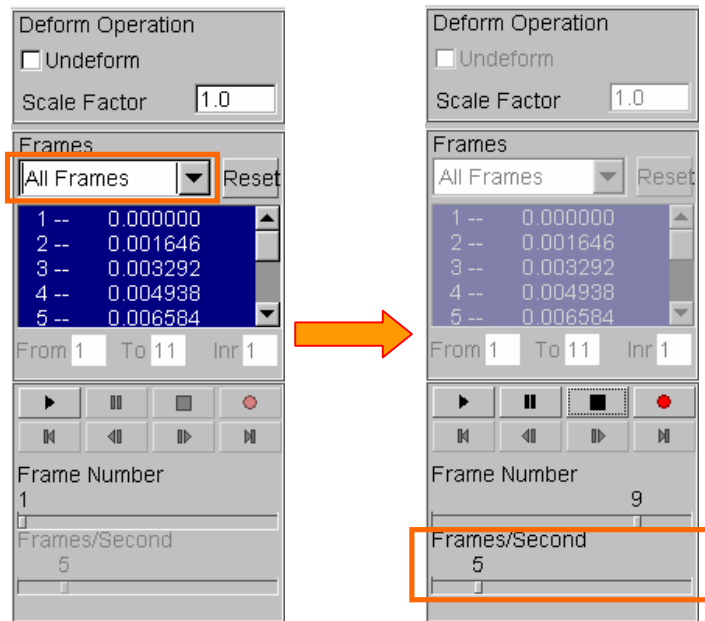

1. Select **All Frames** from the combo box (drop down menu). All the frames are highlighted.
2. Click **Play** button to display animation of deformation.
3. Use the slider to set the desired frame speed.
4. Click **Stop** button.

## Thickness/Thinning



1. Select **Thickness** from the result manipulation menu bar.
2. Select **Current Component** from combo box, either THICKNESS or THINNING
3. Click **Play** button and the animation will begin.
4. Use the slider to set the desired frame speed.
5. Click **Stop** button to stop the animation.

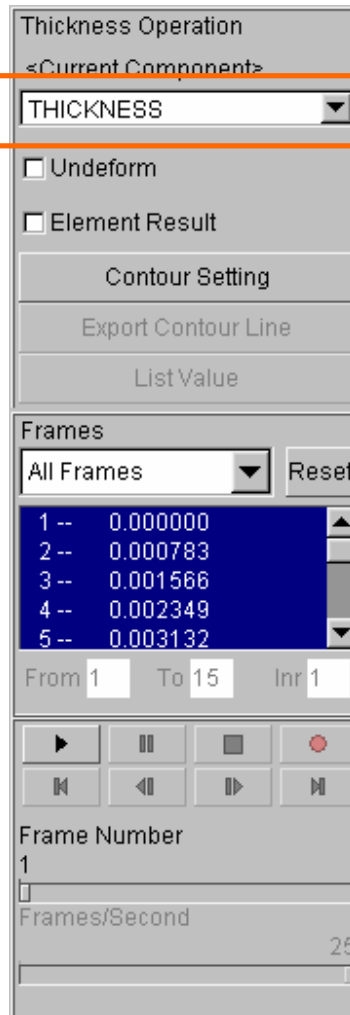

## FLD



1. Pick **FLD** from the result manipulation menu bar.
2. Select **Middle** from the **Current Component** list.
3. Set FLD parameters (n, t, r, etc.) from **FLD Curve Option**.
4. Select **Edit FLD Window** to define location of FLD plot on the display window.
5. Click **Play** button and the animation will begin.
6. Click **Stop** button.

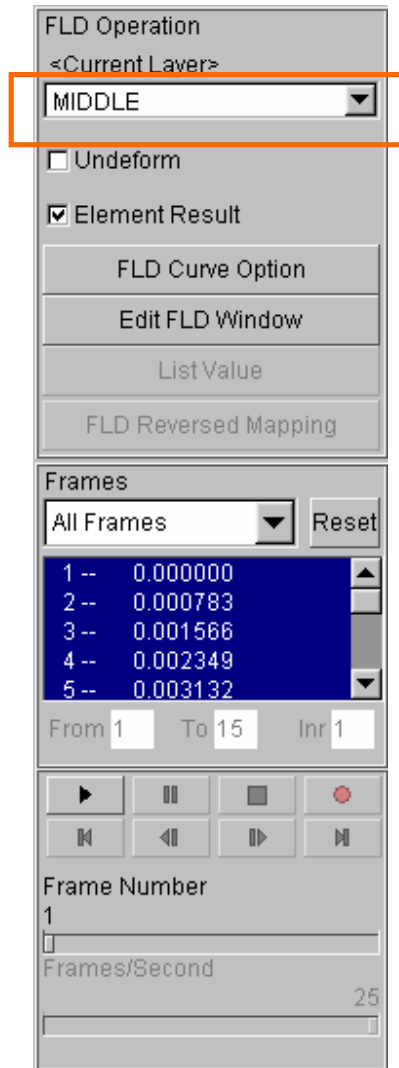

#### IV. Plotting Single Frames

Sometimes, it is more convenient to view single frames rather than the entire animation. To do this, select **Single Frame** from the **Frame** combo box. Then, select with your mouse, the frame you would like to view from the frame list. Users can also drag the slider of frame number to select the frame accordingly.



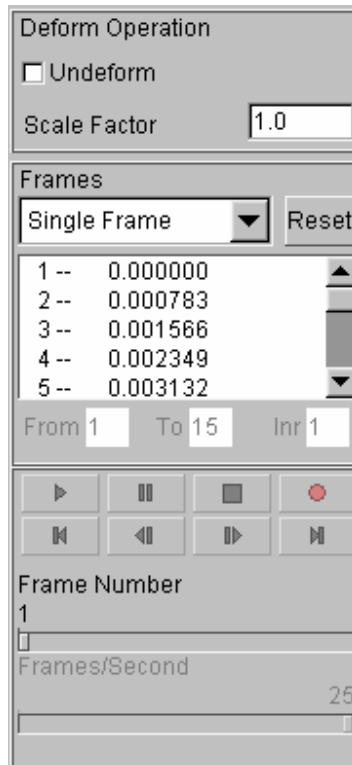

## V. Writing an AVI and E3D File

eta/POST has a very useful tool that allows the user to automatically create an **AVI** movie and **E3D** files via an animation screen capture. This will be the last function covered in this training case.

### AVI movie

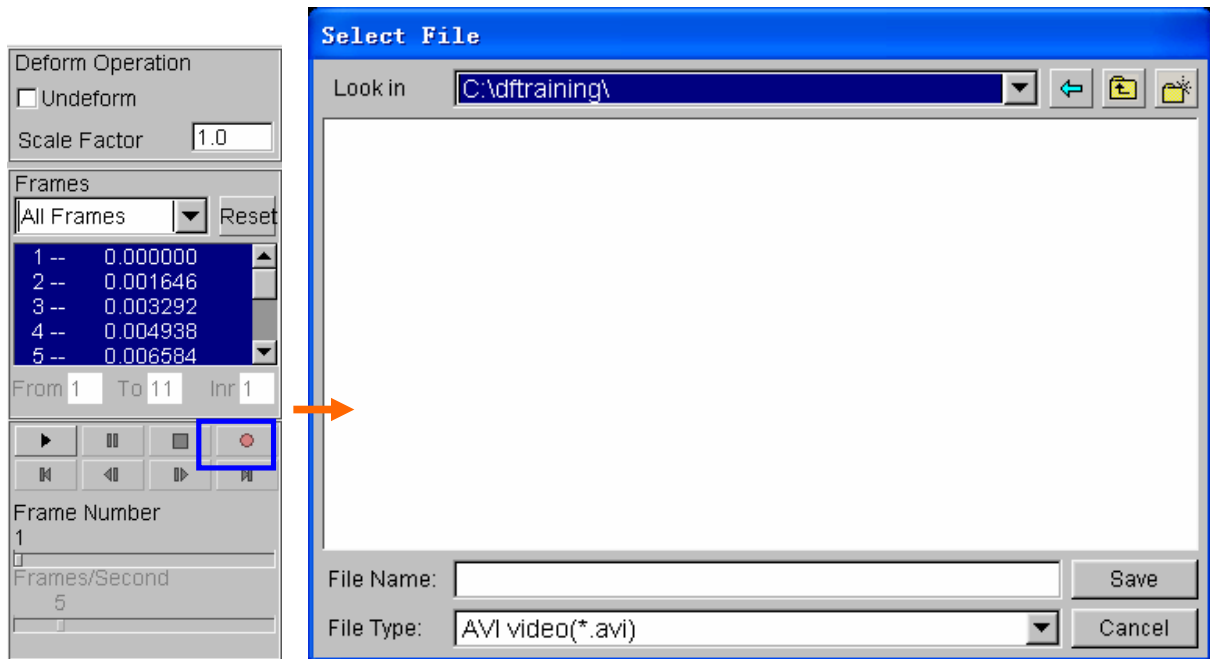

1. Start a new animation using all available steps.
2. Once the animation is running, click the **Record** button located on the dialogue.
3. The **Select File** dialogue will be displayed. Enter a name to save the **AVI** file under (e.g. traincase.avi), and click **Save**.
4. Select **Microsoft Video 1** from the **Compressor** list and click **Ok**.

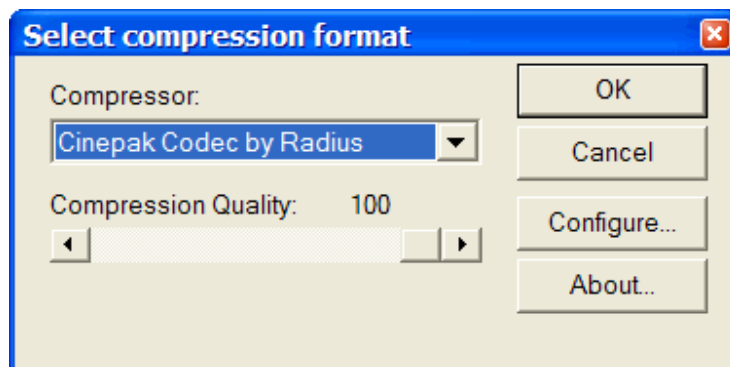

5. eta/POST will take a screen capture of the animation and write the output.

## E3D file

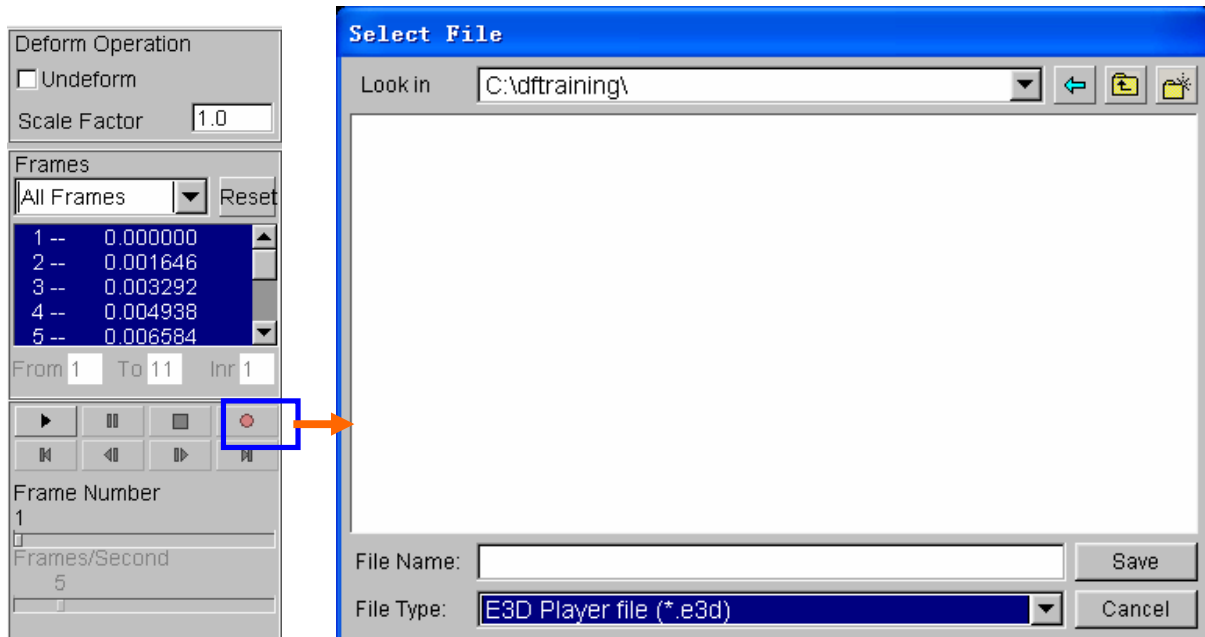

eta/POST allows the user to save simulation results in a much compact file format (\*.e3d). The \*.e3d file can be viewed using **eta/3DPlayer** which is provided free to any users. The users can view 3D simulation results using the player. To start the player, select Start→All Programs→Dynaform 5.2→Eta3DPlayer.

## MORE ABOUT DYNAFORM 5.2

Inside the DYNAFORM 5.2 installation directory, there is a file called **.DyanformDefault**. Many key default parameters are included in this file. Advanced users can change these default parameters to customize the program.

For Unix/Linux users, the **.DynaformDefault** file is located under both the installation directory and the user's home directory. The **.DynaformDefault** file located under the installation directory will take precedence over the one located in the user home directory.

## CONCLUSION

This concludes the training guide's basic overview of **eta/DYNAFORM 5.2**. This manual is meant to give the user a basic understanding of finite element modeling for forming analysis, as well as displaying the forming results. It is by no means an exhaustive study of the simulation techniques and capabilities of **DYNAFORM**. For more detailed study of **DYNAFORM**, the user is urged to attend a **DYNAFORM** training seminar.

Please reference the **DYNAFORM** and the **LS-DYNA User's Manuals** for detailed explanation of individual functions and analysis settings.