



A new advanced THOR 5th crash test dummy finite element model development representing small female occupant

# Agenda

1. Background
2. Possible NCAP Tests
3. Differences towards THOR-50<sup>th</sup>
4. Overview
5. Instrumentation and Sensors
6. Biofidelity tests
7. Certification tests
8. Ribcage deformation in the sled
9. Sled comparison with HIII-5<sup>th</sup>
10. Outlook and roadmap
11. Conclusion

# Background

- THOR 5<sup>th</sup> percentile female ATD (THOR-5F) is needed to represent the small **female occupant group** for restraint system development
- First THOR-5F **prototype** was built in the early **2000's**
- Humanetics started its own THOR-5F **development** in **2014**
- **NHTSA awarded Humanetics** a contract to develop a THOR-5F in **2015**
- **Final design decisions** were made collectively through discussions between **NHTSA and Humanetics**
- **LS-DYNA** model 0.5 FE model available since **January 2018**
- NHTSA **Biofidelity Ranking System** (BioRank) **1.28** (good biofidelity)

# Possible NCAP Tests

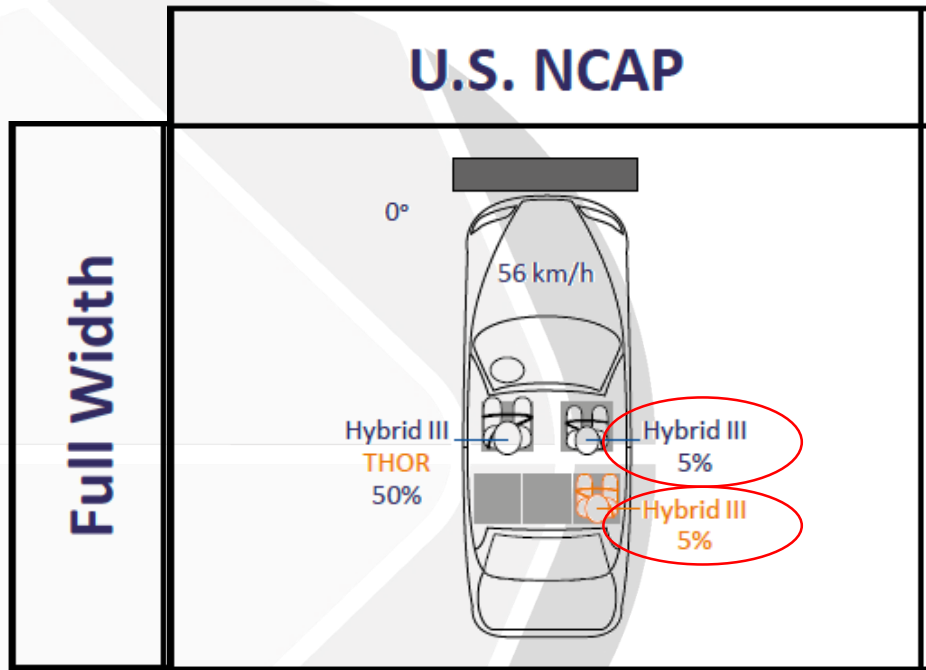

# Differences towards THOR-50<sup>th</sup>

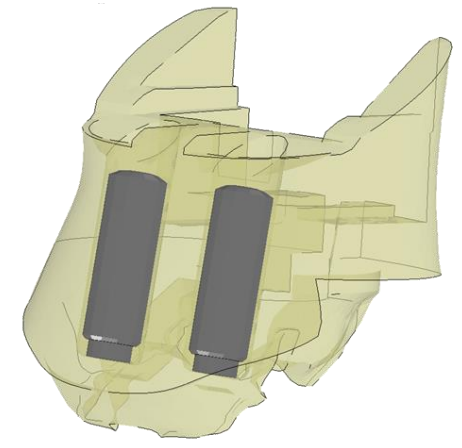
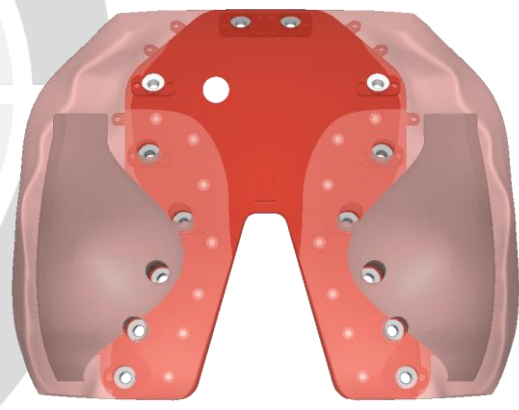
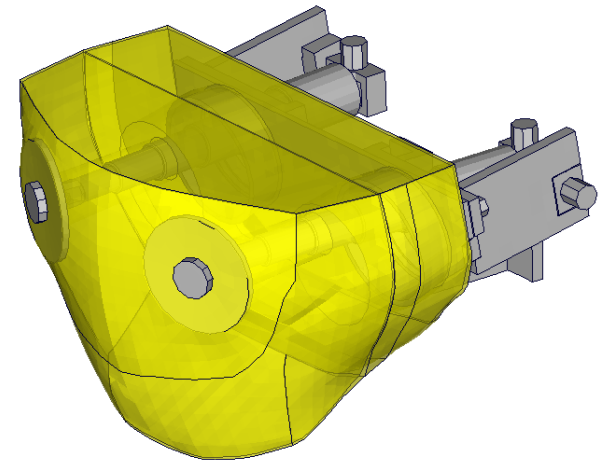

Head with honeycomb structure

Chest flesh with foam insert

Abdominal pressure twin sensors

# Overview

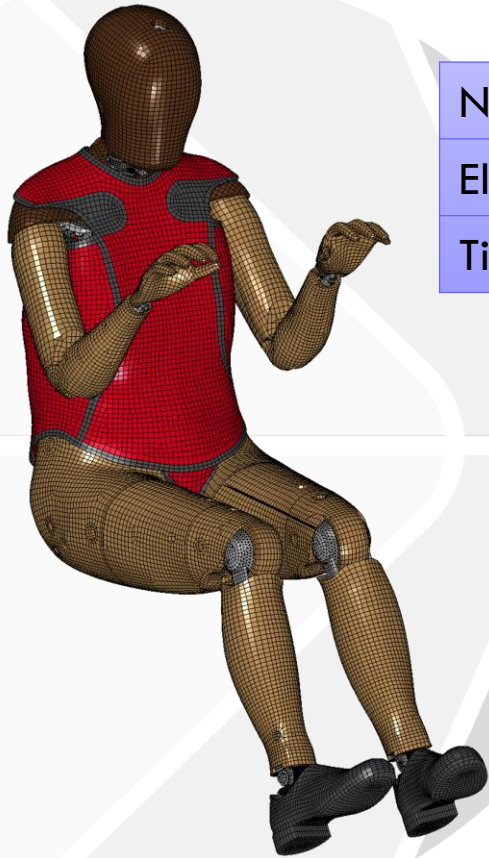

Nodes	< 400K
Elements (All)	< 670K
Time-step	0.7 micro-sec





# Biofidelity Tests

# Face bar impact (Biofidelity test)

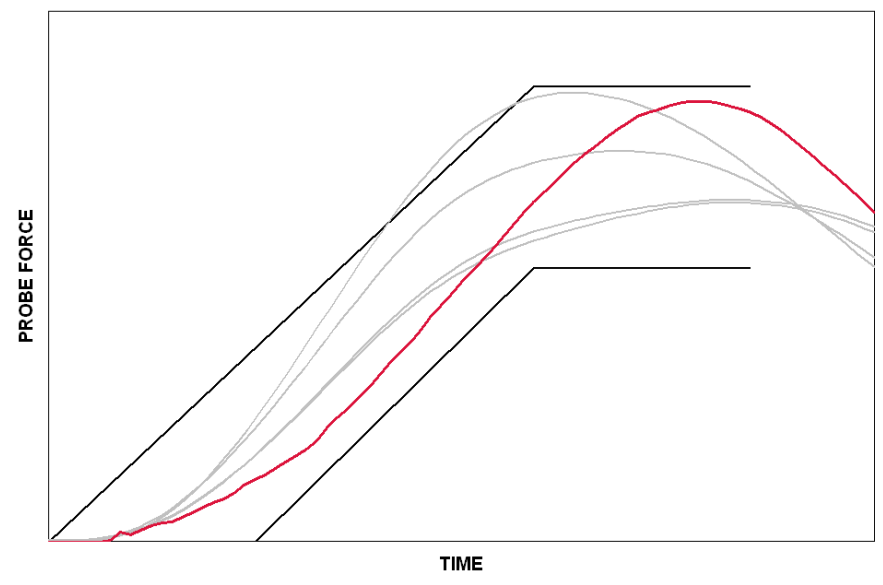
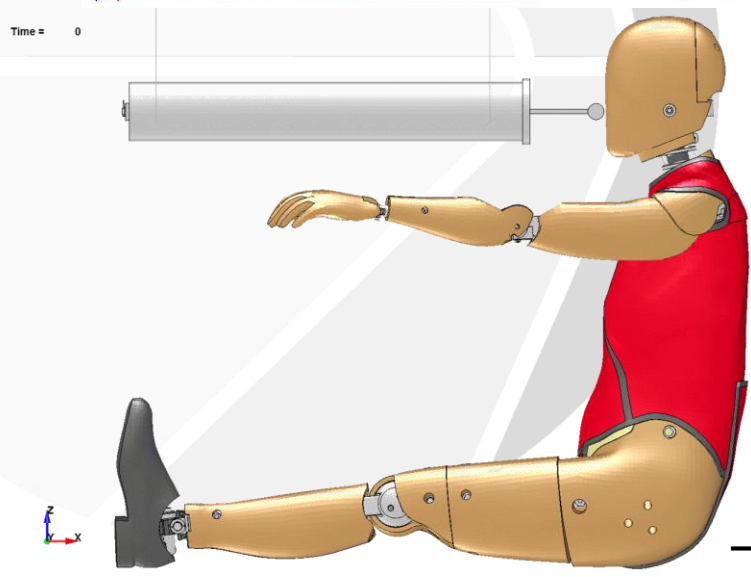
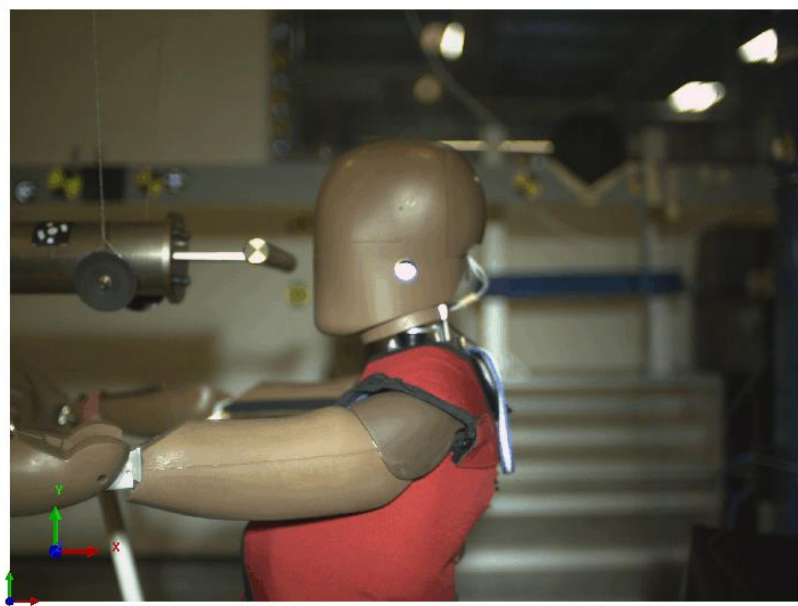

— Biofidelity Corridors — Test — FEA V0.5



# Thorax impact (Biofidelity test)

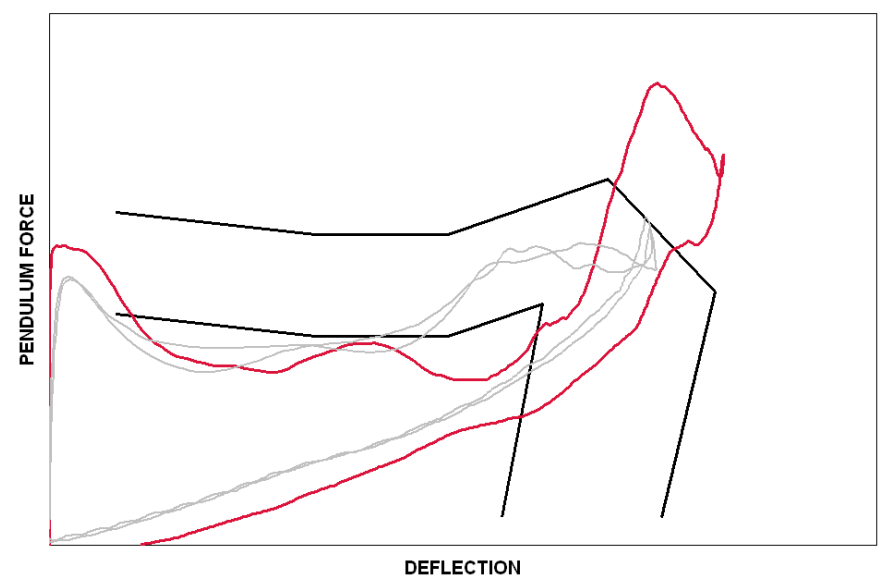
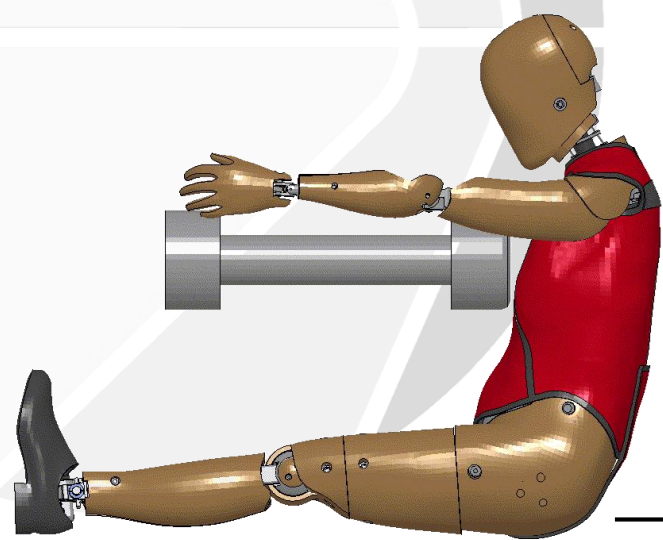

— Biofidelity Corridors — Test — FEA V0.5

# Upper abdomen steering wheel impact (Biofidelity test)



Time = 0

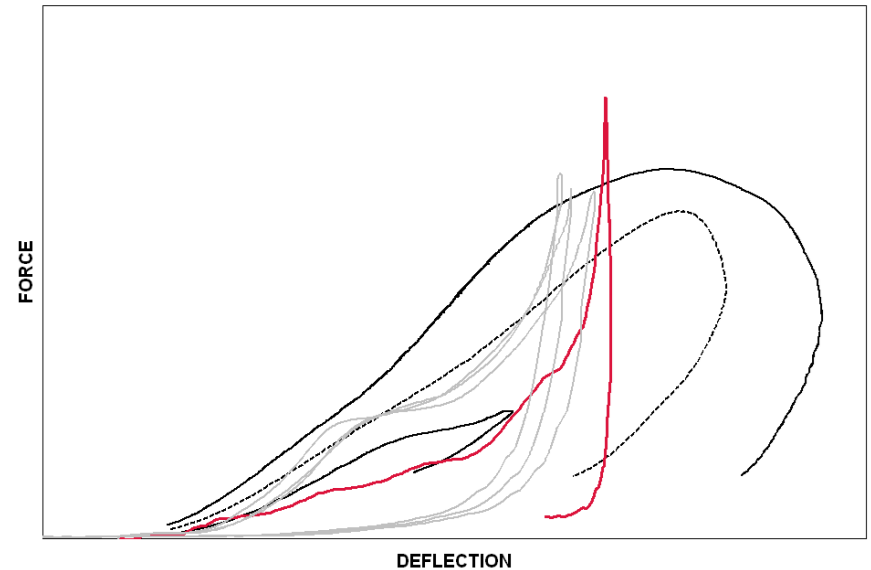
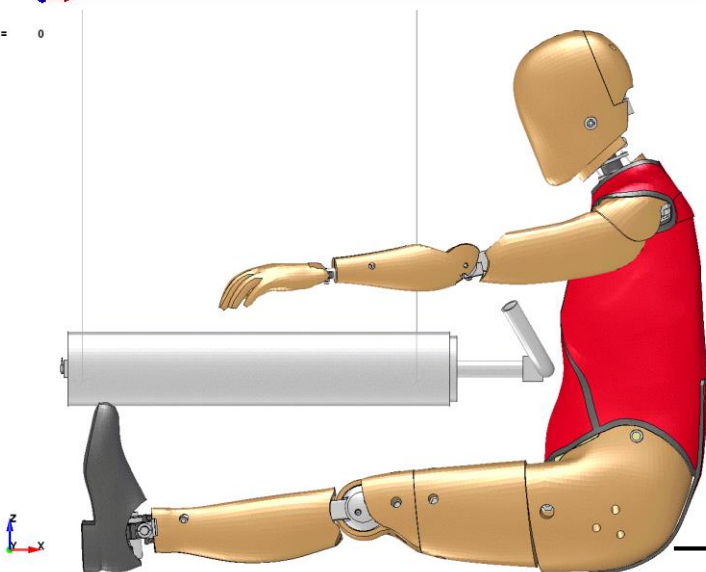

— Biofidelity Corridors — Test — FEA V0.5

# Lower abdomen bar impact (Biofidelity test)

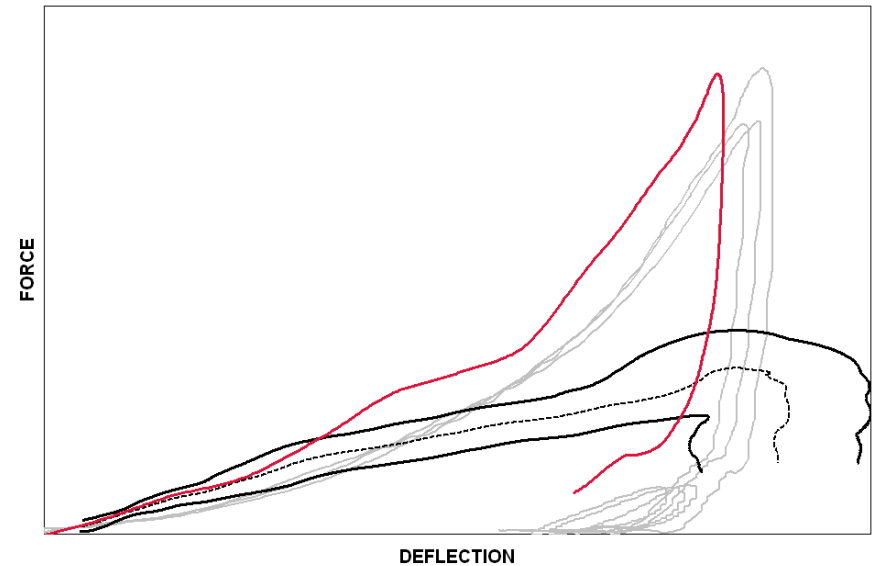
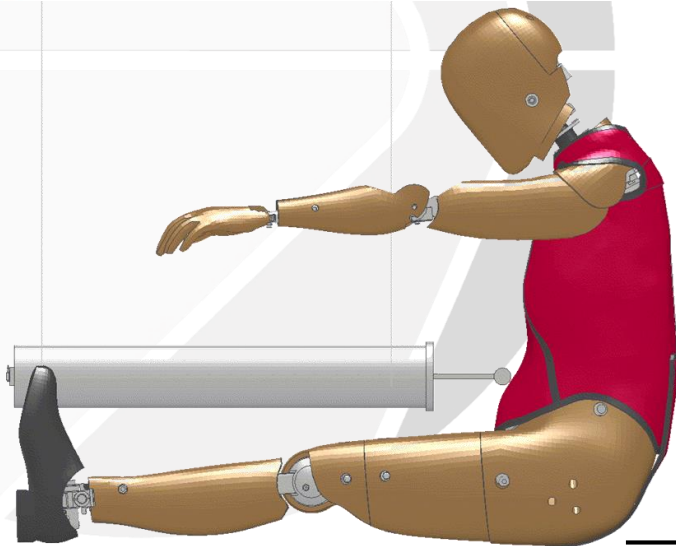

— Biofidelity Corridors — Test — FEA V0.5



# Certification Tests

# Certification test matrix

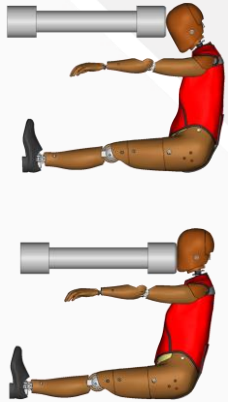

Forehead
Face Rigid Disk



Upper Thorax
Lower Thorax



Lower Abdomen
---------------

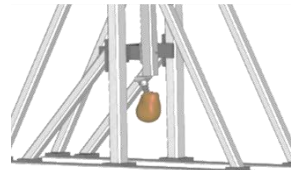

Flexion
Extension
Lateral Flexion
Torsion



Knee Impact
Knee Slider

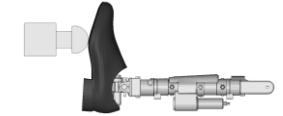
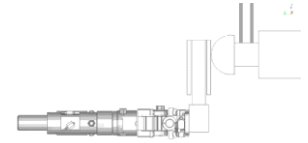

Ankle Inversion
Ankle Eversion
Ball of Foot
Heel of Foot

5  
10  
15

Full dummy tests  
Component tests  
Tests

# Forehead Impact

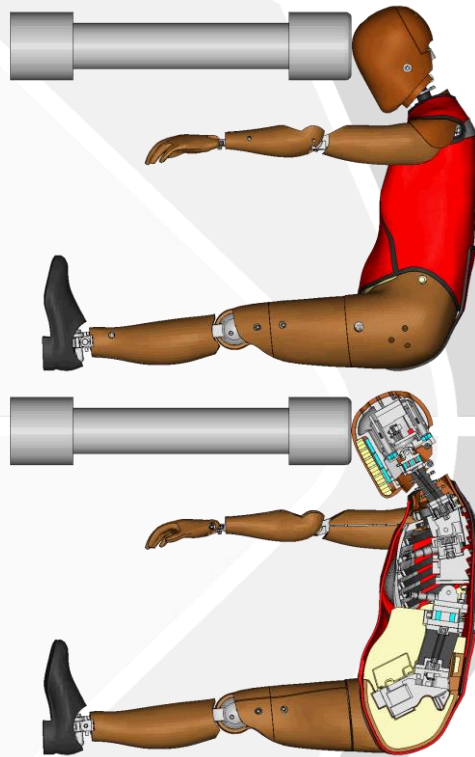

Force (kN)

Probe Force

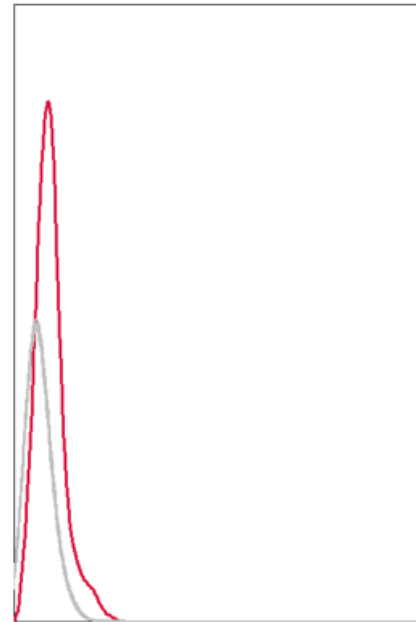

Time (ms)

Head Resultant Acceleration

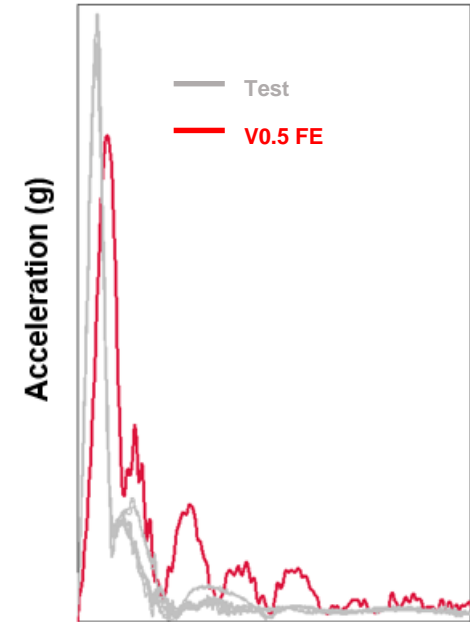

Time (ms)

# Face Rigid Disk Impact

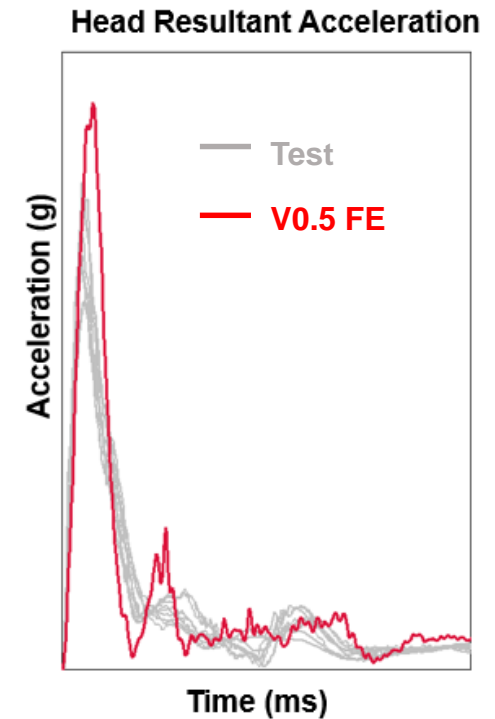
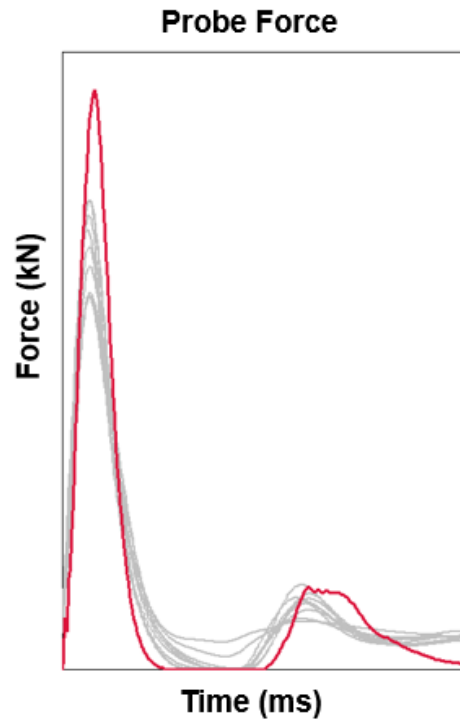
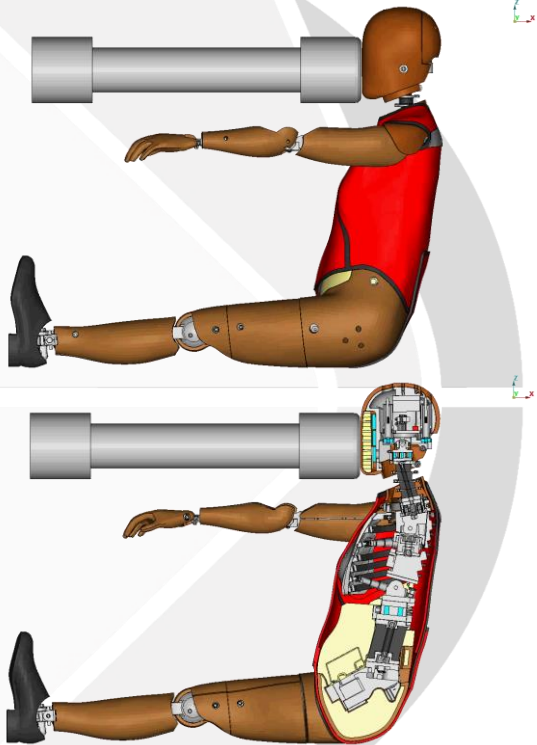

# Neck Flexion

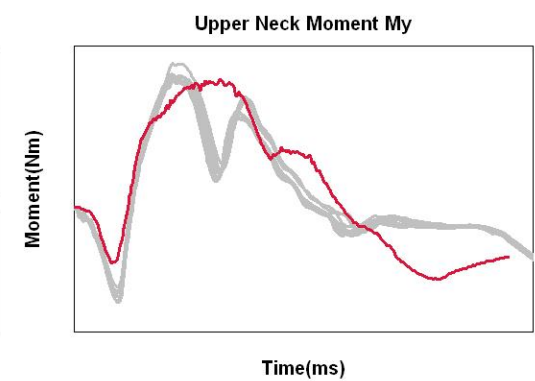
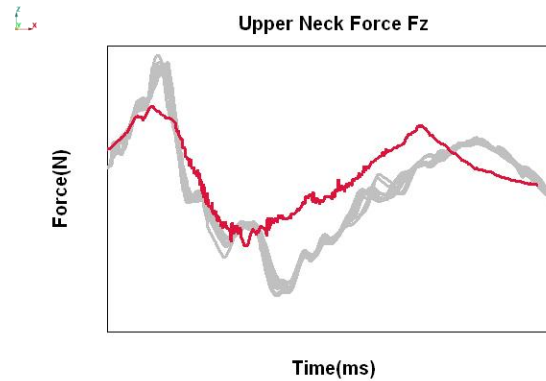
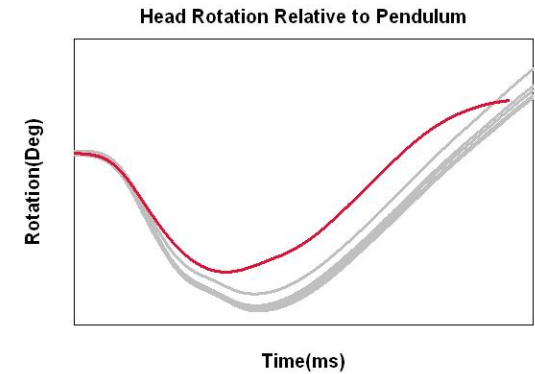
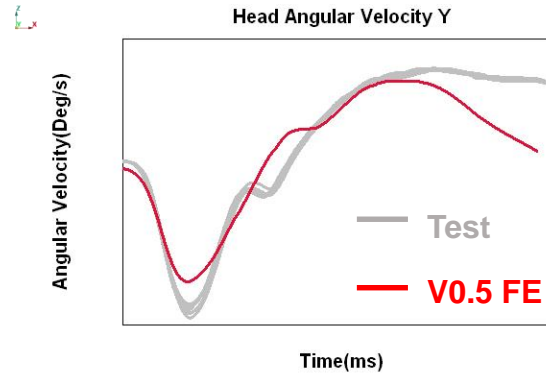
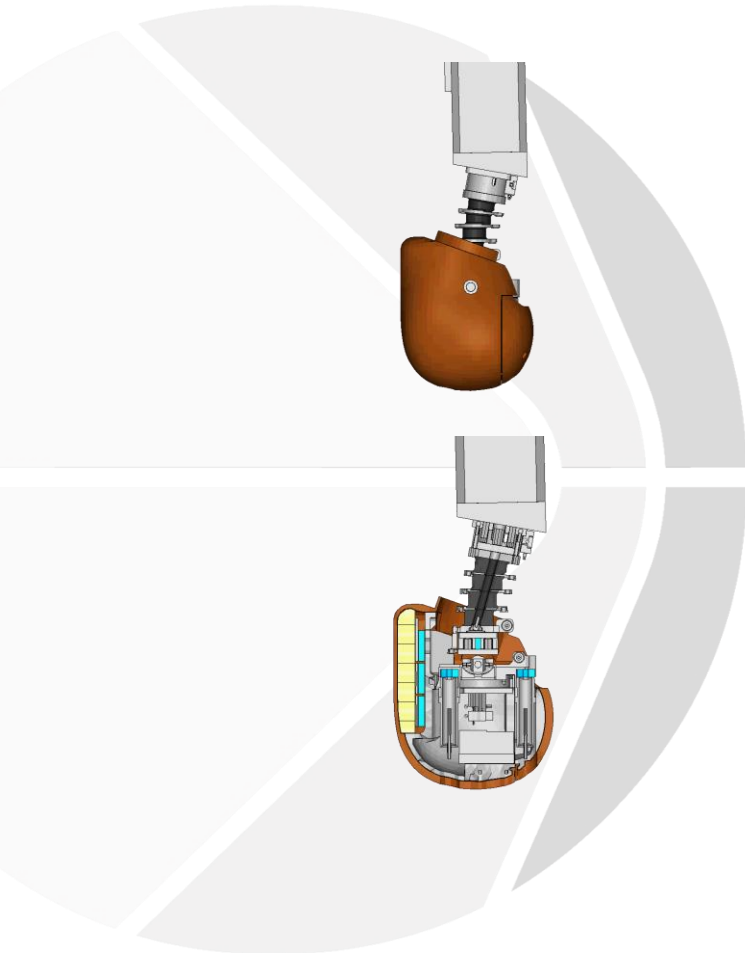



# Neck Extension

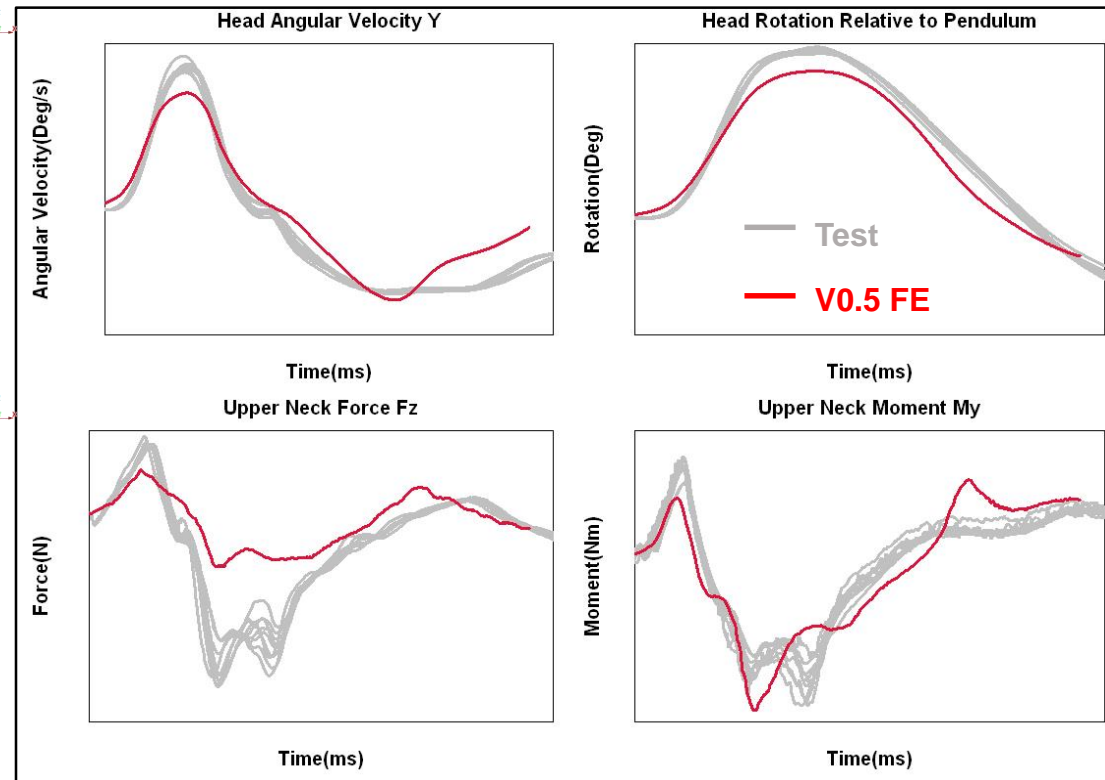
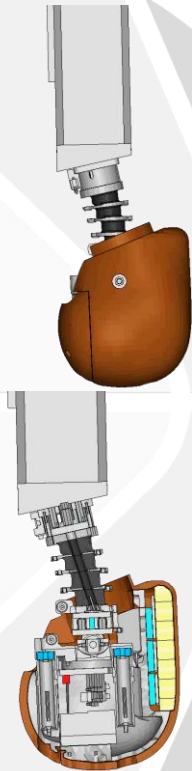

# Neck Lateral Flexion

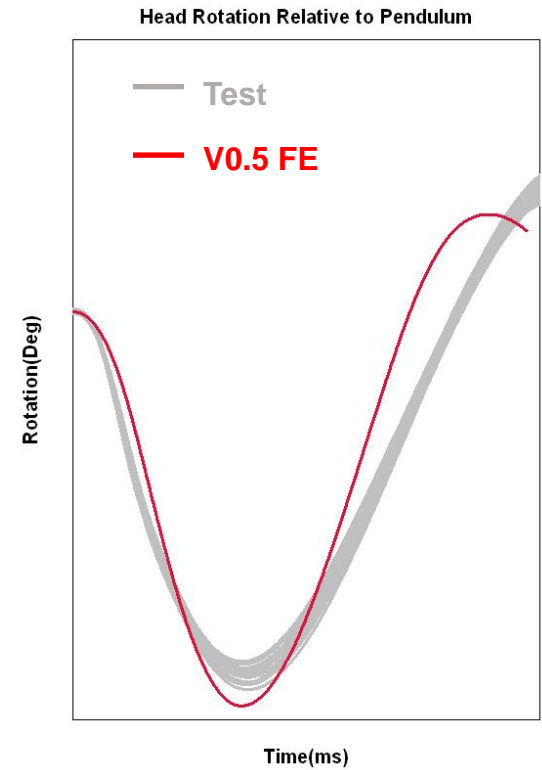
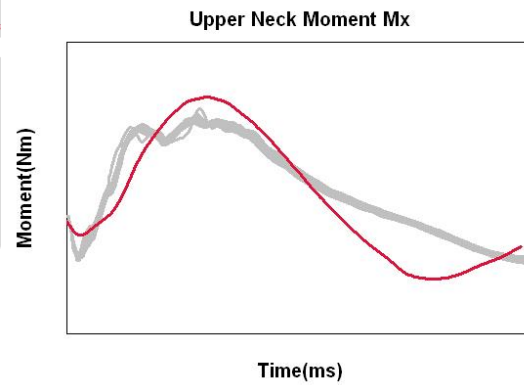
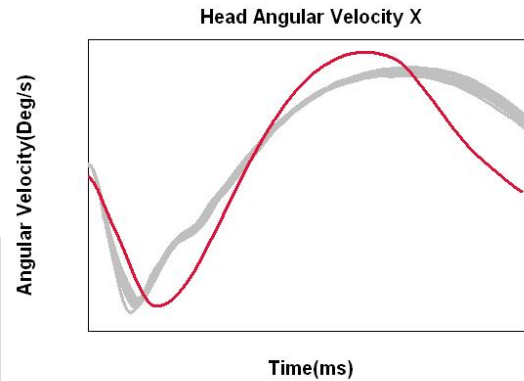
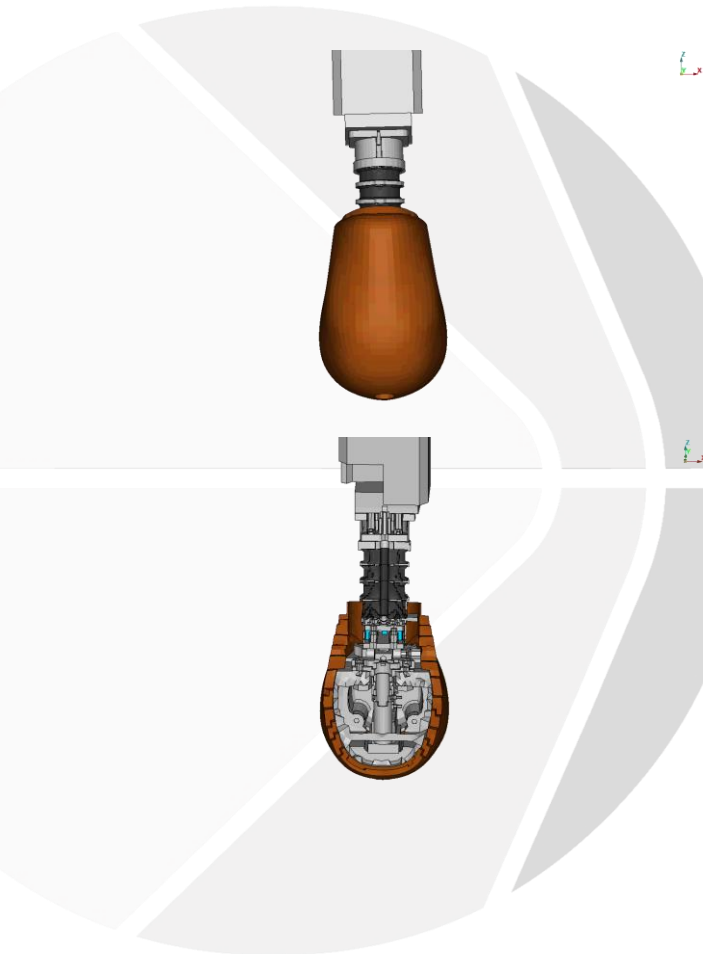

# Upper Thorax Impact

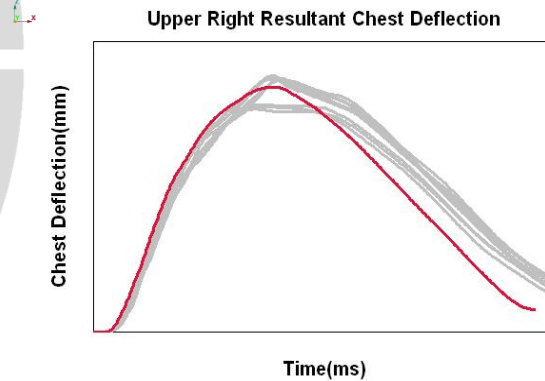
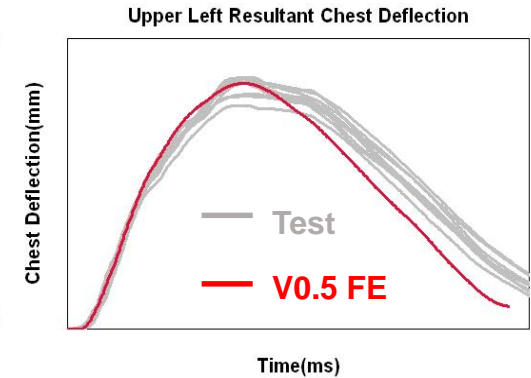
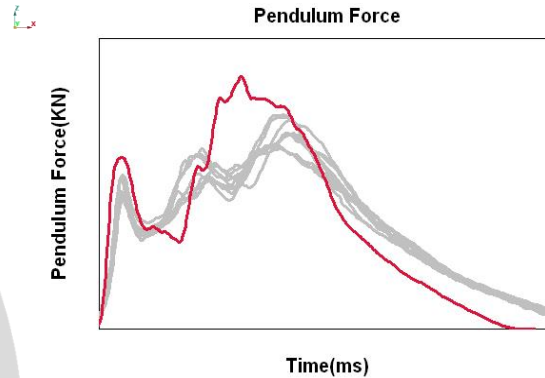
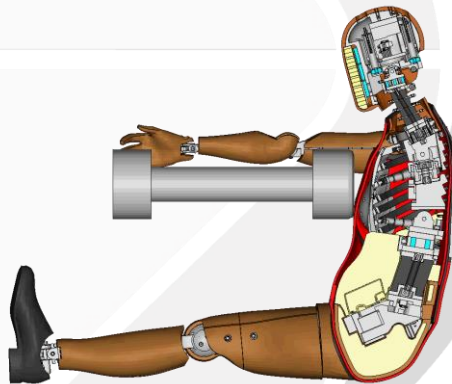
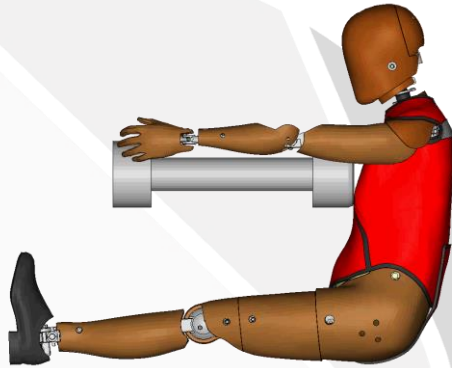

# Lower Abdomen Impact

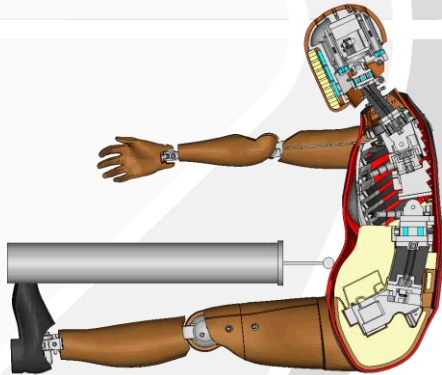
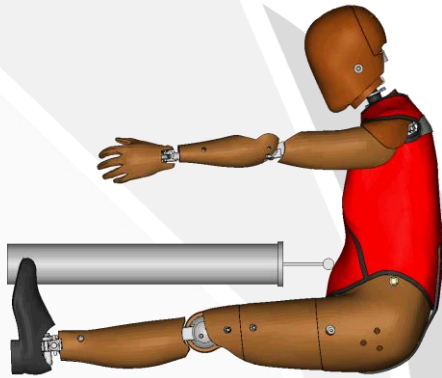

Pendulum Force

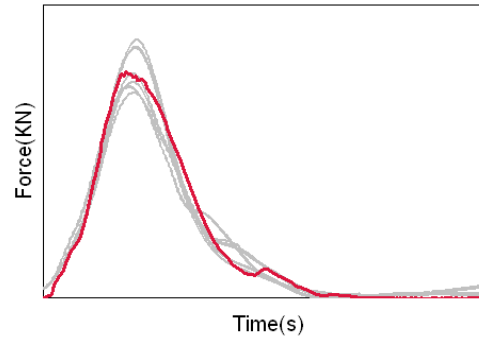

Right Abd Pres Sensor

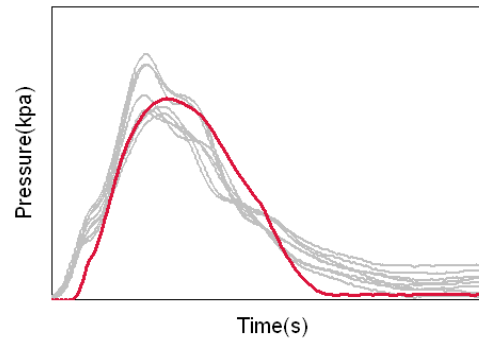

Left Abd Pres Sensor

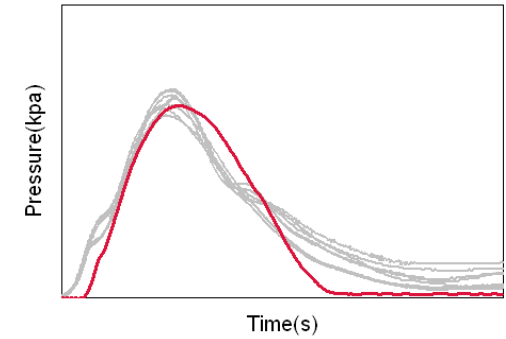

— Test  
— **V0.5 FE**

# Knee Slider Impact

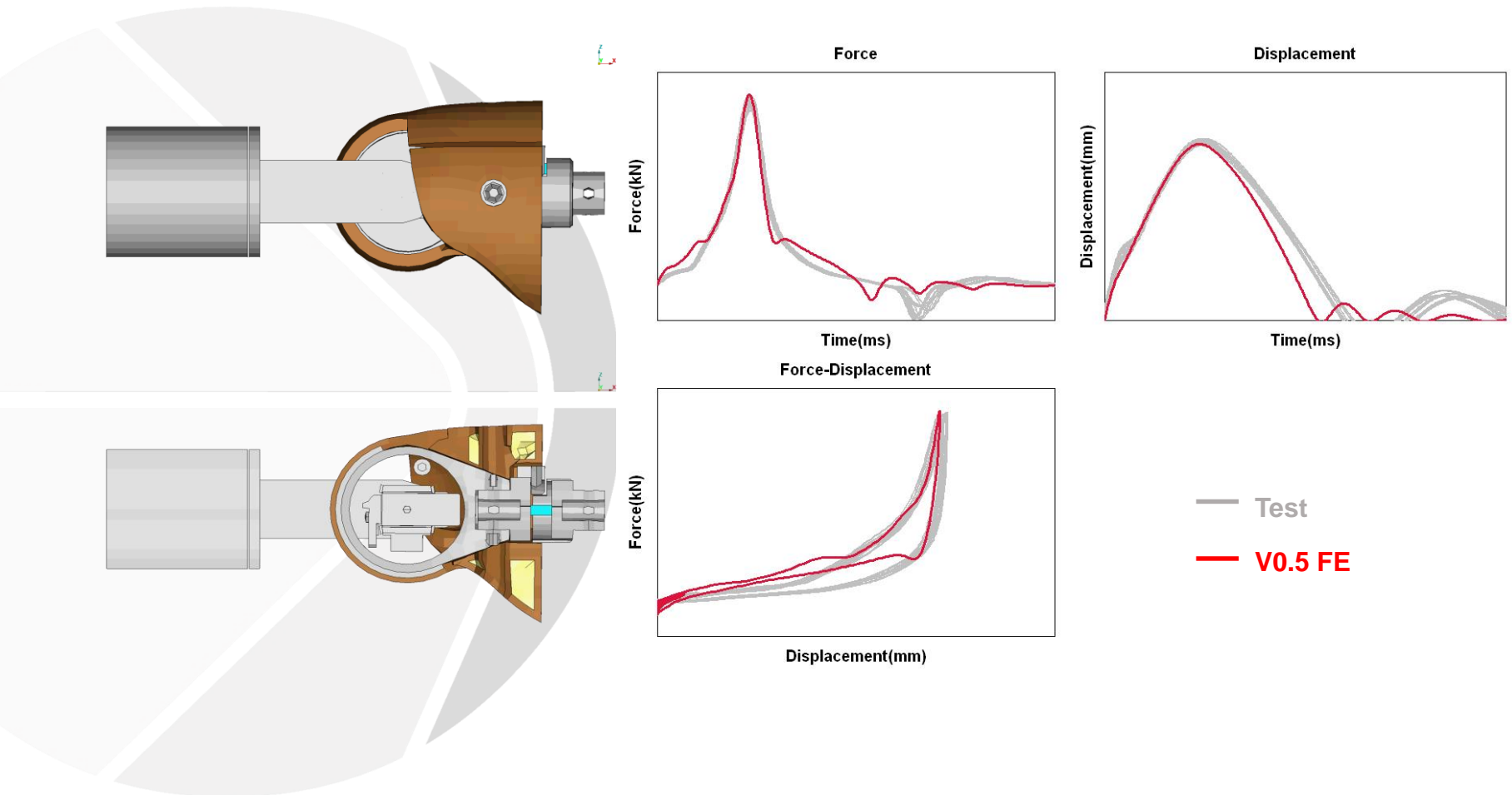

# Ribcage deformation in the sled

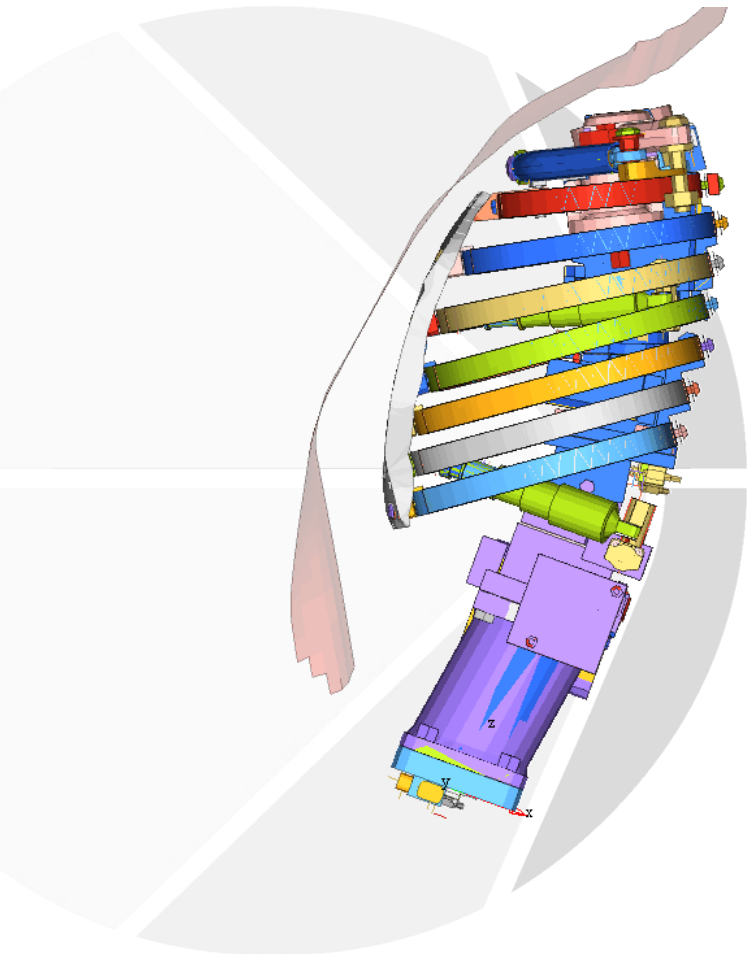

Right upper

Left upper

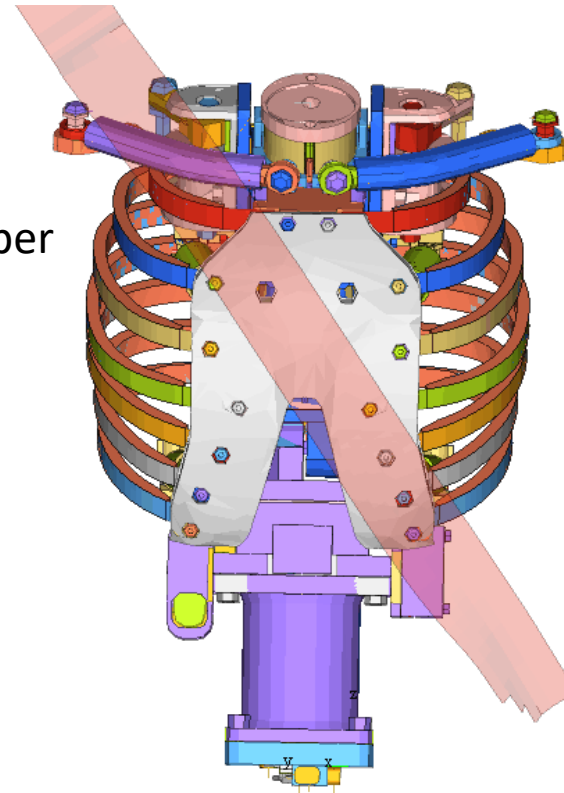

Right lower

Left lower

# Sled comparison with HIII-5th

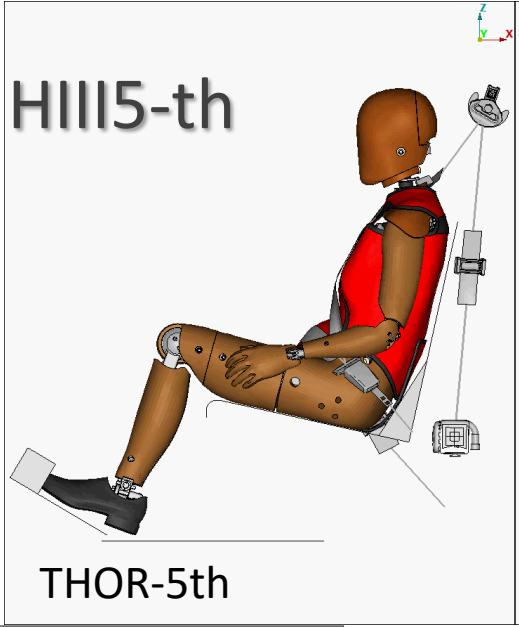

THOR-5th

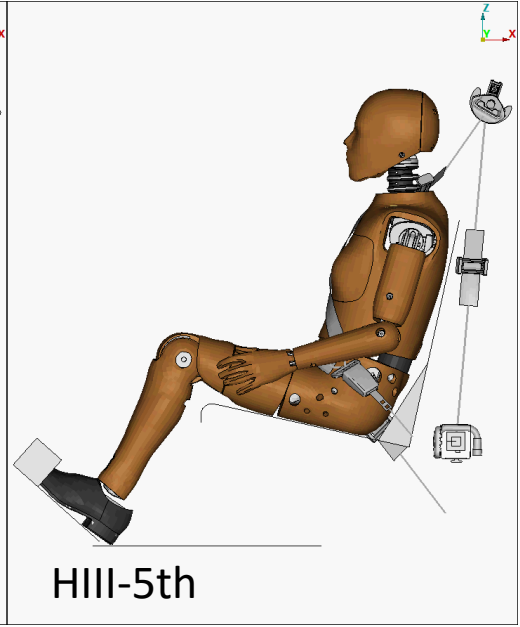

HIII-5th

Chest Deflection

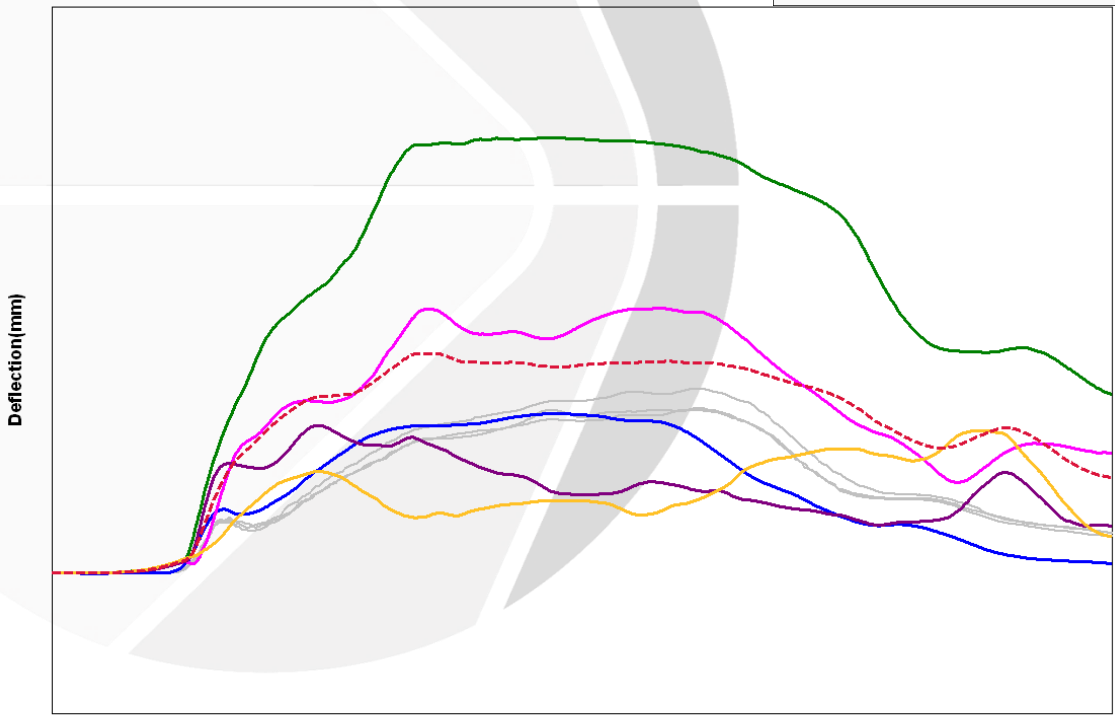

- HH3-05F Test
- - THOR-05F Average of four IR-TRACC FE
- THOR-05F Upper Left IR-TRACC FE
- THOR-05F Upper Right IR-TRACC FE
- THOR-05F Lower Left IR-TRACC FE
- THOR-05F Lower Right IR-TRACC FE
- HH3-05F FE

# Outlook and roadmap

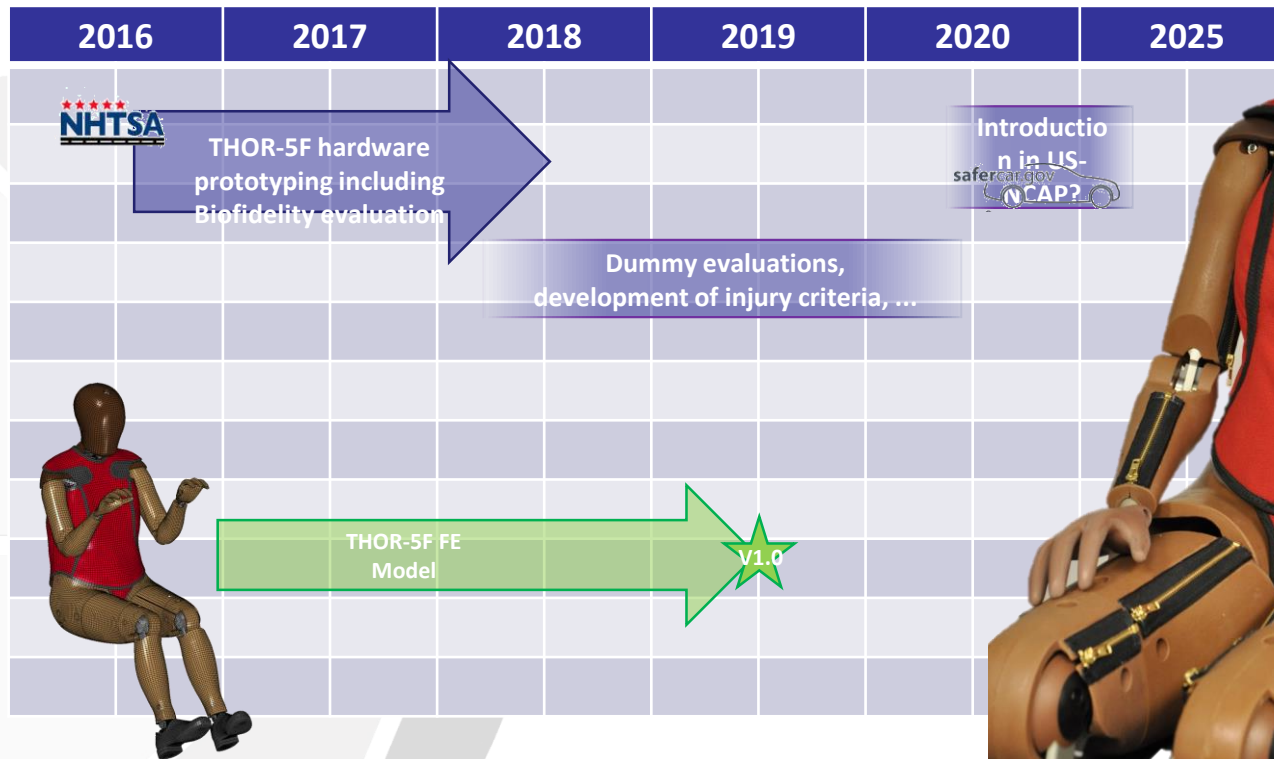

## Content of Version 1.0

- Component testing and validation
- Material testing
- Any additional hardware changes and customer feedback
- Initial validation against one of the sled (we are planning tests at Autoliv early 2019)



A blurred background image of a humanoid robot, possibly a prosthetic or advanced prosthetic, holding a tablet. The robot is positioned on the left side of the frame, and the background is a light, out-of-focus indoor setting.

# Thank you very much for your attention

© 2018 Humanetics Innovative Solutions, Inc.

This presentation is the proprietary property of Humanetics Innovative Solutions, Inc; a registered company in Plymouth, Michigan, USA. The report includes confidential information. Disclosure, use, copying, or distribution of this information without the written authorization of Humanetics Innovative Solutions is prohibited.