

The Use of LS-OPT in the Development of Jaguar Adaptive Passenger Airbag including: Folding, OOP, Calibration and Optimisation

T. Zeguer

Jaguar Cars

Modelling accurately passenger airbags has been a great challenge for both OEM and airbag suppliers. Although JLR suppliers were requested to deliver LS-DYNA models for PAB assemblies, they would use other tools to fold airbags and translate them into LS-DYNA. This process of conversion required a great deal of correction and was time consuming, leading to program delays and lost confidence in the reduction of the large number of tests associated in the development of Out Of Position (OOP). The motivation of this project is to develop a complete process using LS-DYNA and LS-OPT in the development of an adaptive PAB for OOP.

The OOP process includes a realistic folding, inflator representation using particle method, use of LS-OPT for auto correlation and robustness prediction.

The Use Of LS_OPT in the development of an adaptive PAB

“Folding, OOP, Calibration and optimisation”

Dr Tayeb Zeguer
&
Eduardo Arvelo

Contents

- Introduction
- The OOP Simulation Challenges
- Gas Dynamics for inflator modelling
- PAB Folding Process
- Auto Correlation for PAB to Test Rig
- Robustness Results of NHTSA Positions 1 and 2
- Conclusions

Introduction

The PAB needs to perform in two conflicting scenarios:

➤ In Position :

- Occupant is correctly seated.
- PAB is almost fully deployed before occupant interaction.
- Performance driven by : stiffness, total inflator output and venting

➤ OOP :

- Occupant is not in position.
- PAB needs to offer just enough protection, or not deploy at all.
- Performance driven by :The unfolding sequence, early gas venting, geometry, stiffness, dynamic inflator output and venting.

The OOP Simulation Challenge

- Design for OOP is about balancing the transient behaviour of the inflator and airbag with the geometry of the occupant in close proximity to the IP. Thus, uniform pressure assumptions are not valid as the dynamic behaviour of the inflator gasses play a crucial role.
- Some of the expected challenges are summarised below:
 - Choice of gas inflation technique - ALE (Arbitrary Lagrangian Eulerian Method) or CPM (Corpuscular Particle Method)
 - Folding process - chaotic scrunch fold which has no regular origami pattern
 - Numerical instabilities (element formulation, contact algorithm, modelling robustness, fabric material behaviour e.g. elasticity, porosity, directionality)

CAE Analysis with the Passenger Airbag Model

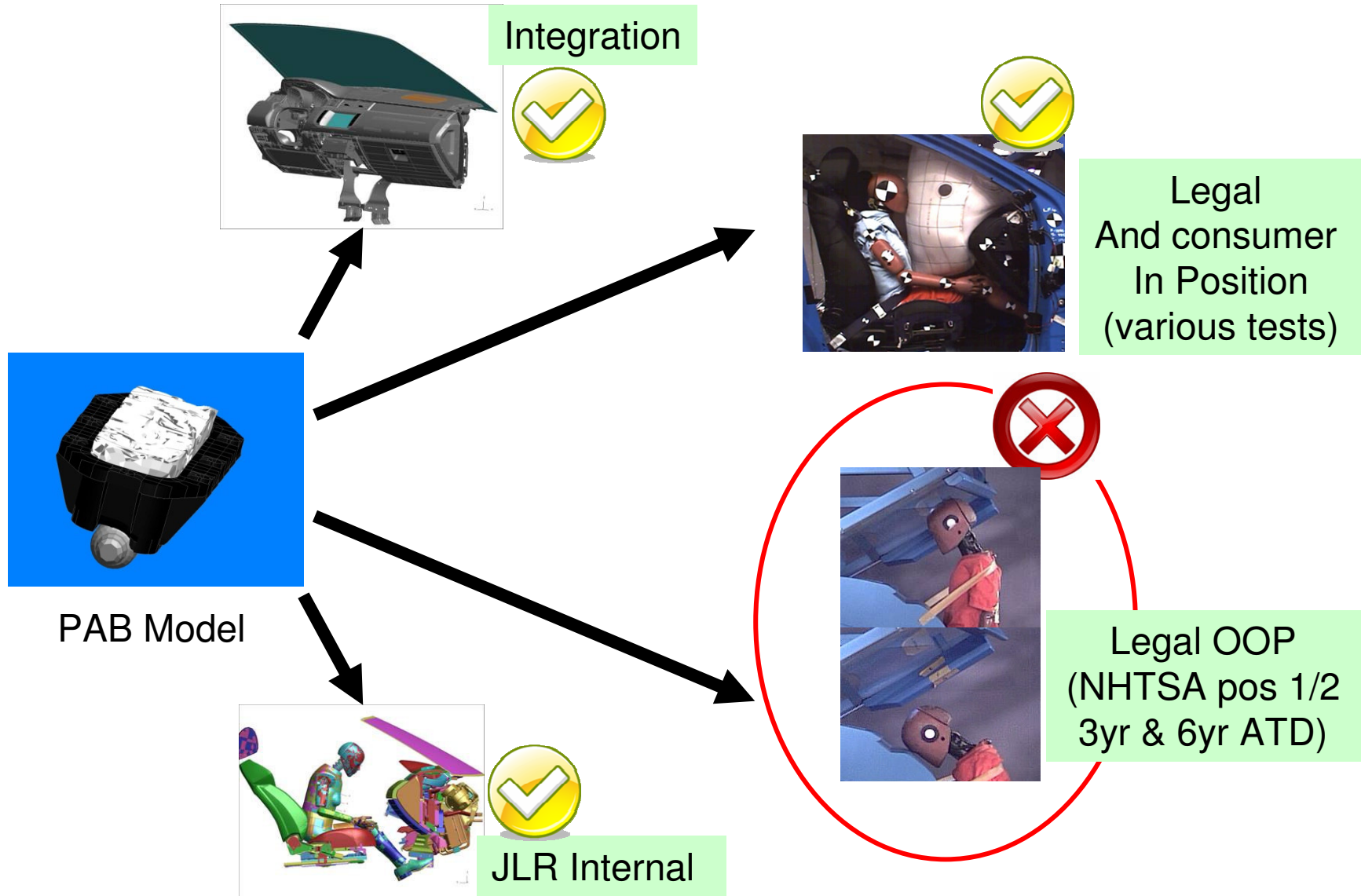

NHTSA OOP positions 1&2 for 3yr and 6yr ATD

3 Years Old

6 Years Old

Position 1

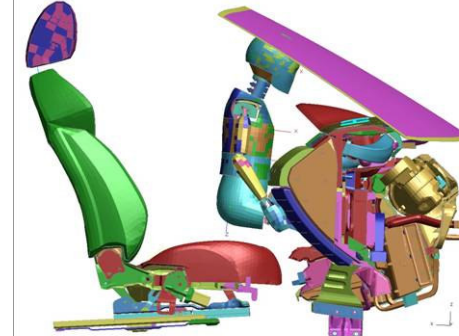
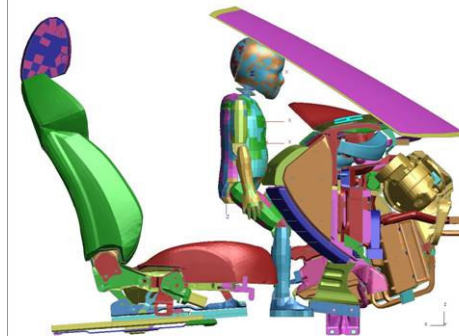

Position 2

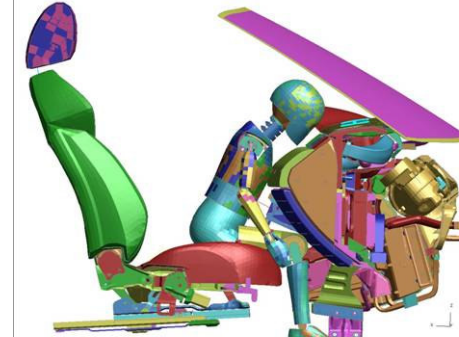
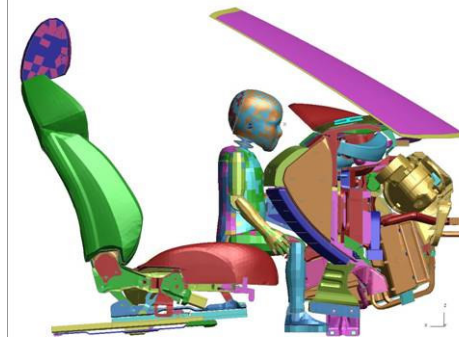

Stages of model build for PAB OOP analysis

Higher quality model required for complex OOP events

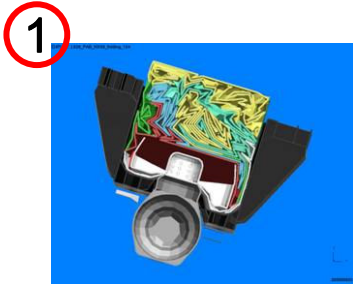

Detailed model build
(full folding information)

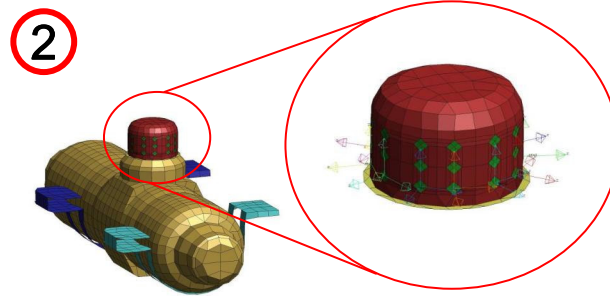

Inflation using advanced
Gas Dynamics

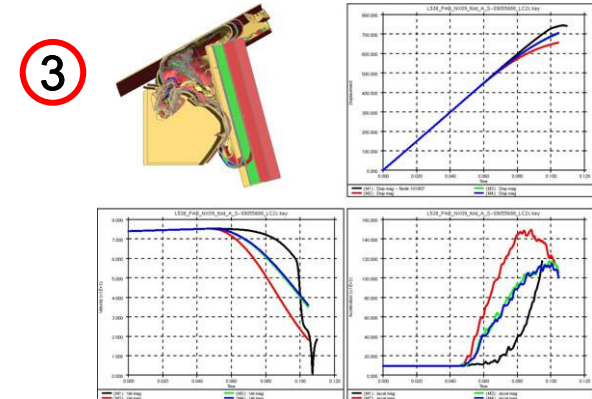

Correlation to multiple tests

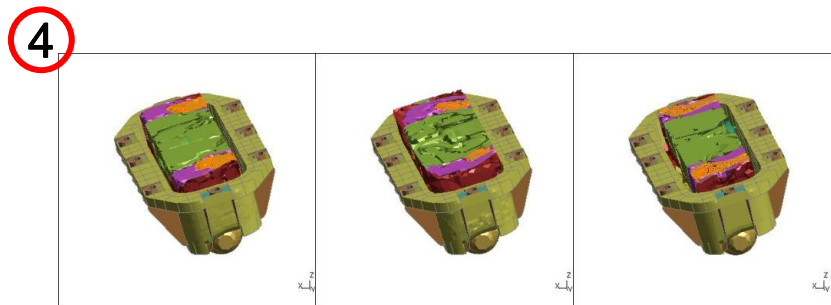

Robustness Analysis

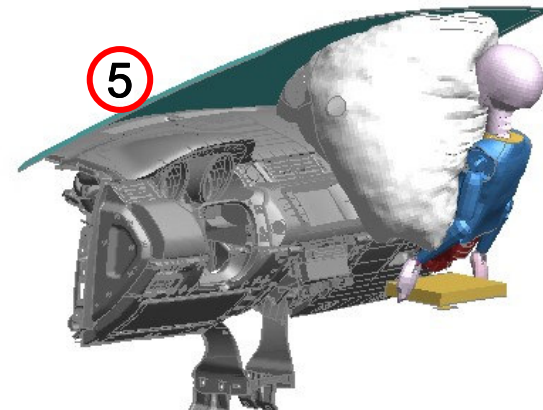

Prototype verification

AIRBAG INFLATION
GAS DYNAMIC MODELLING

Gas Dynamics

- OOP initial model approach was based on **ALE**. Though this can be as accurate as needed, it has challenges of its own. The biggest drawbacks include the required computational power to achieve acceptable simulation turn around time.
- The Corpuscular Particles Method (**CPM**), offers a more viable approach. It is significantly less computationally intensive than ALE

Inflator Representation

- To Specify the gas initial direction **LS_DYNA** requires Vectors, normal to each of the inflator outlets.
- Local coordinate systems, attached to the inflator, are used to define the required vectors. This way, the vector coordinates always make reference to their respective local system.
- This is done to facilitate the inflator reposition without having to redefine the vectors after a global rotation or translation of the Passenger Airbag module.

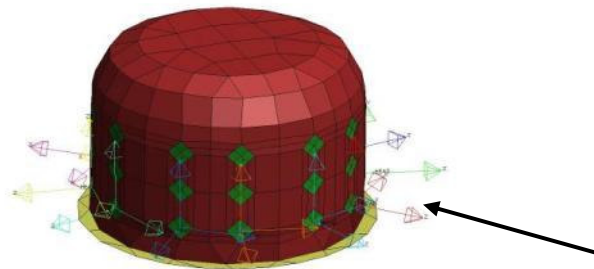

Local Coordinate Systems

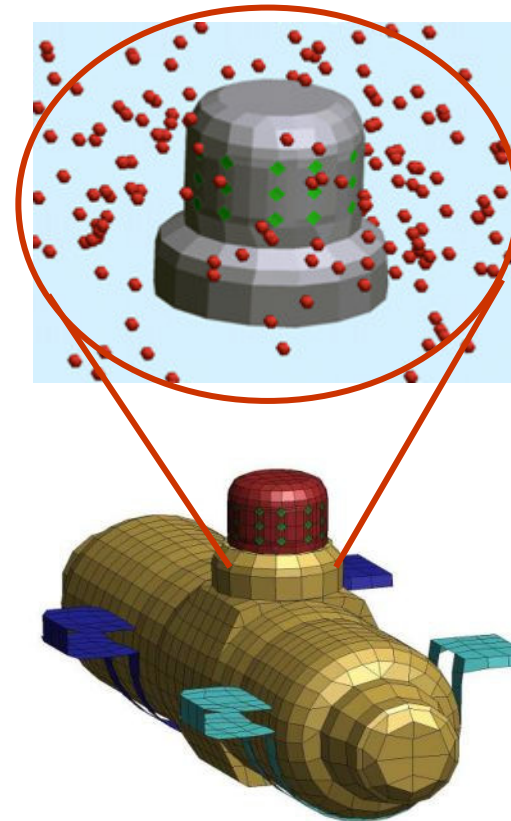

Inflator Tank Test Correlation

- Using LS-DYNA CPM
- This is a new feature in LS-DYNA, hence requires investigation and good understanding to realise full potential
- Using 60 litres tank for correlation



PLOT: inflator_tank_wat_P30_100key



Inflator Tank test correlation : Pressure Variation

- Pressure readings from small areas, like the front and top sensors, are very noisy.
- Because pressure is calculated from the particles' collisions, the reading depends on the size of the surface area and the number of particles in contact at a given point in time.

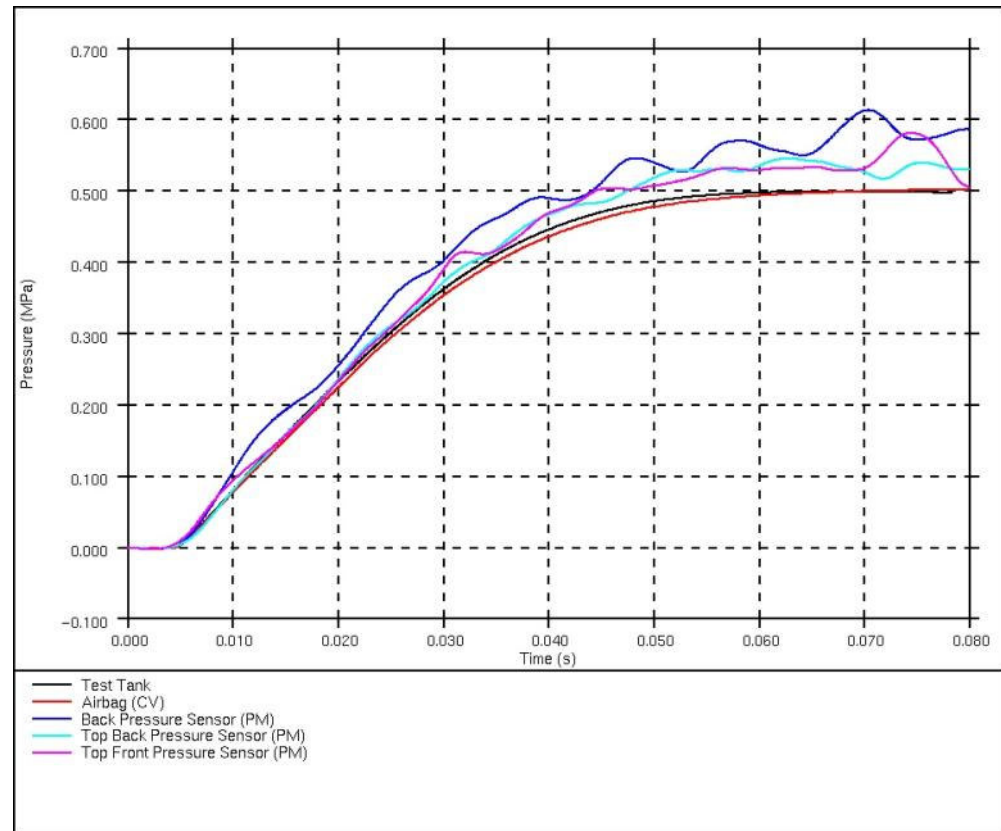

Inflator Correlation

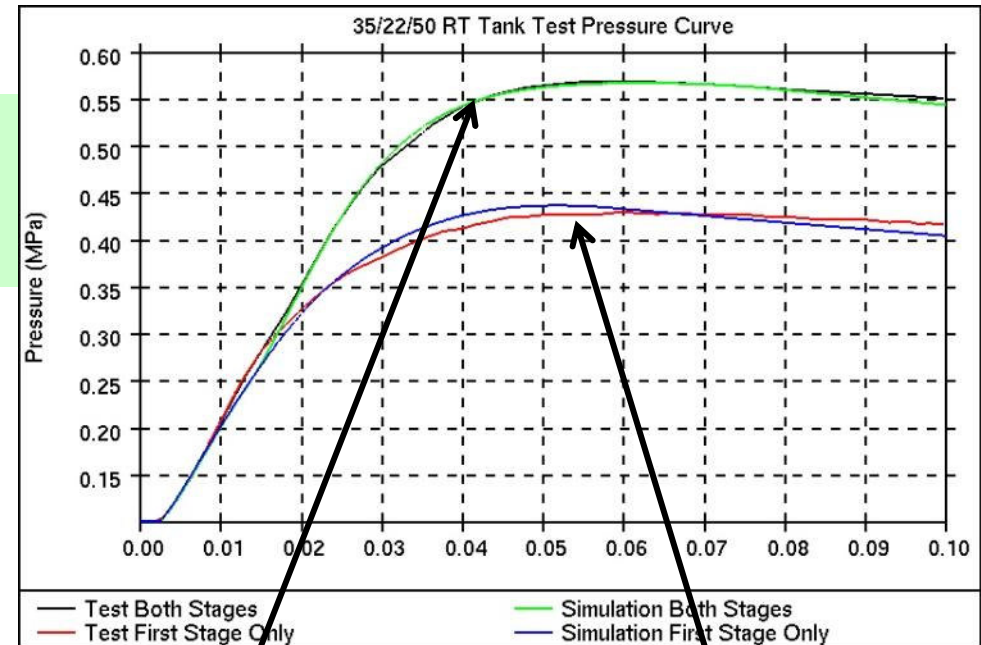
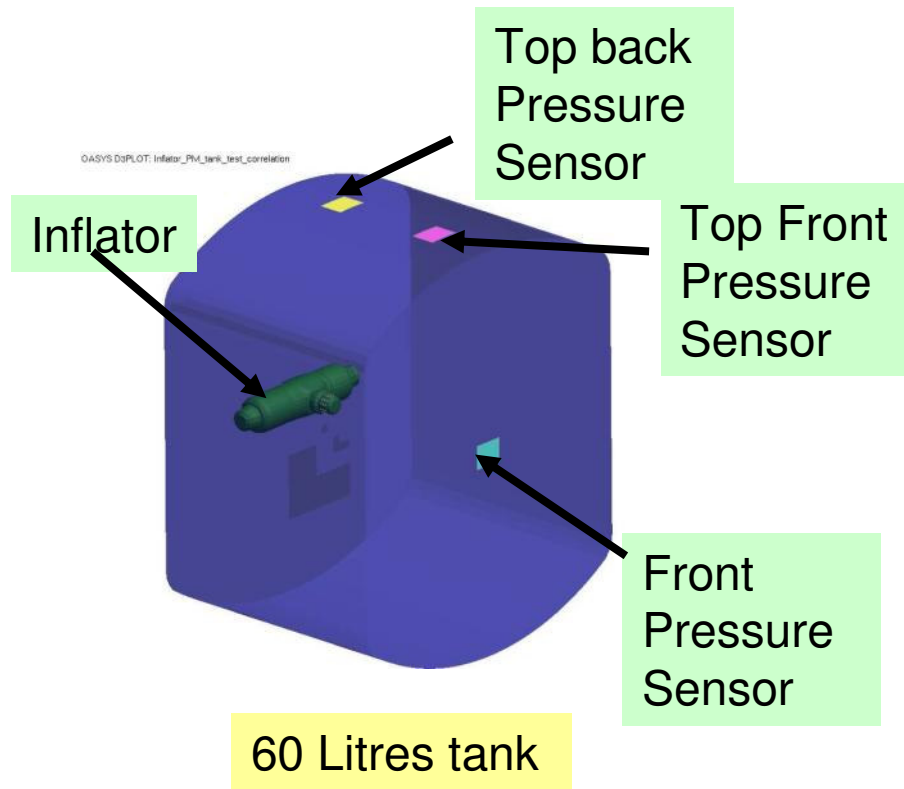

1st and 2nd stage

1st stage inflation

CAE CUSHION CREATION
CREATING THE FABRIC MESH

PAB CAE Mesh Creation

- The CAE model was reverse engineered from the prototype bag, using seam and marking lines as reference.
- A 3D CAE version of the bag is built using this geometry

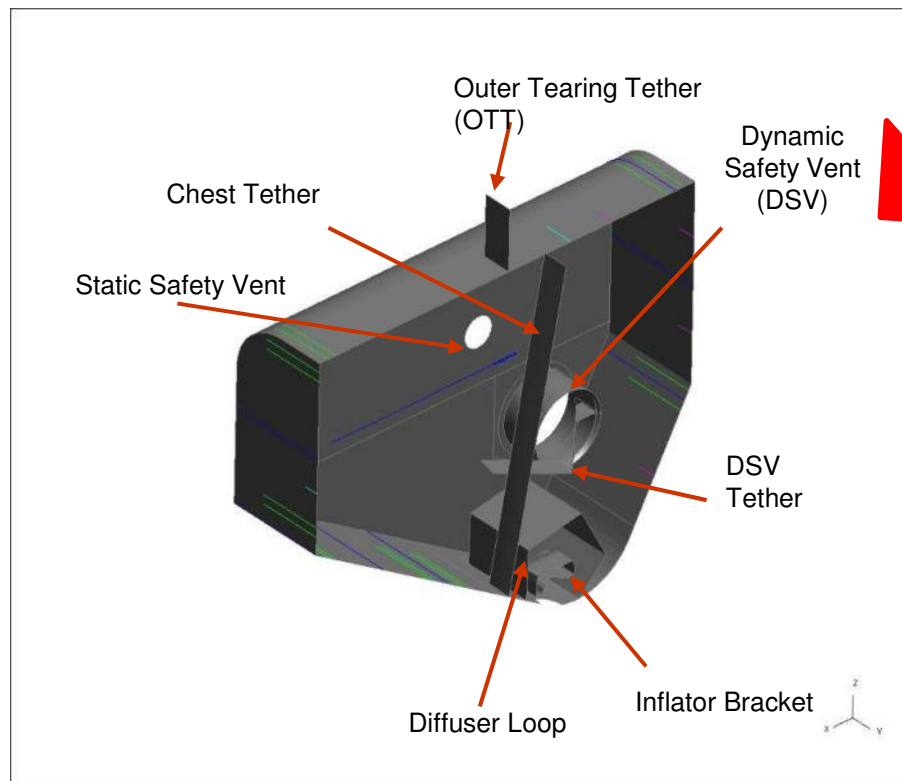

Front Panel



Side Panel



DSV



DSV Reinforcer



Back Panel



Inflator Bracket

PAB CAE Mesh Creation

- A 10x10 regular mesh is applied to most of the parts.
- Dynamic Safety Vents are meshed with 5x5 triangular elements to:
 - Provide necessary extra detail
 - Avoid hourglass problems due to extreme distortion during operation/closing.

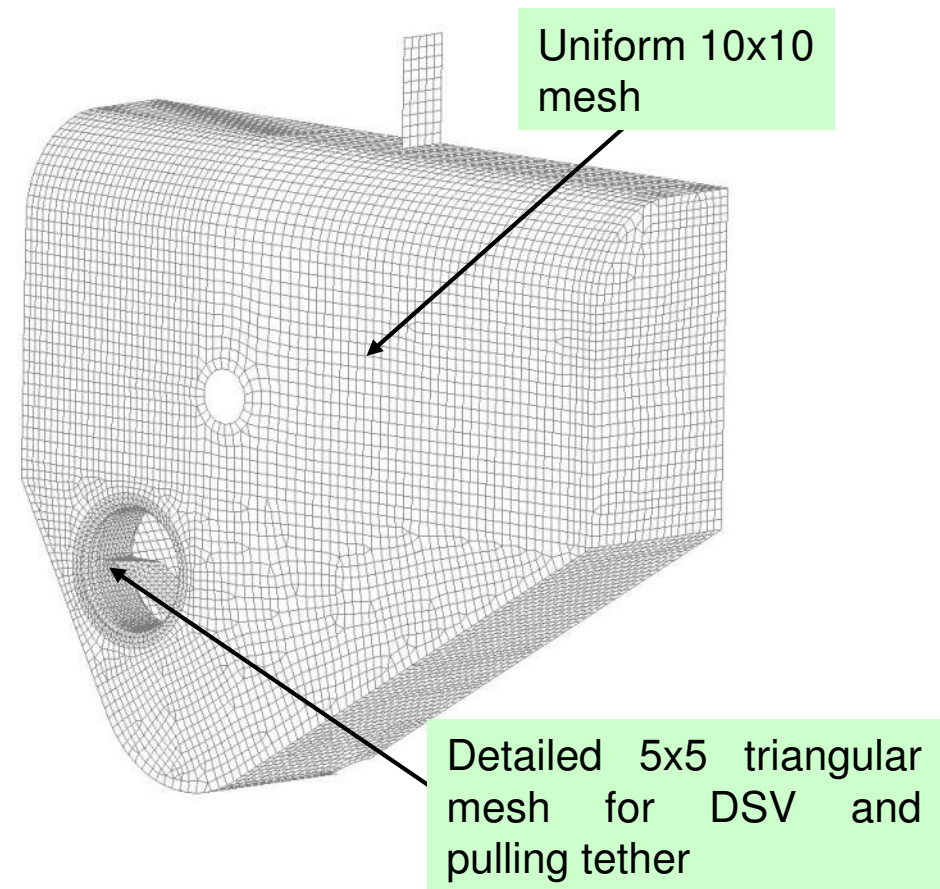

Modelling of Dynamic Safety Vent (DSV)

- The cross section cut of the DSV shows that a 1.5 - 2 mm gap between fabric layers of fabric.
- This is necessary to help the contact and avoid cross edges and minimise penetrations.
- The fabric material thickness, for contact purposes only, is 1.5 mm.
- The real thickness, used for analyses, is 0.35 mm

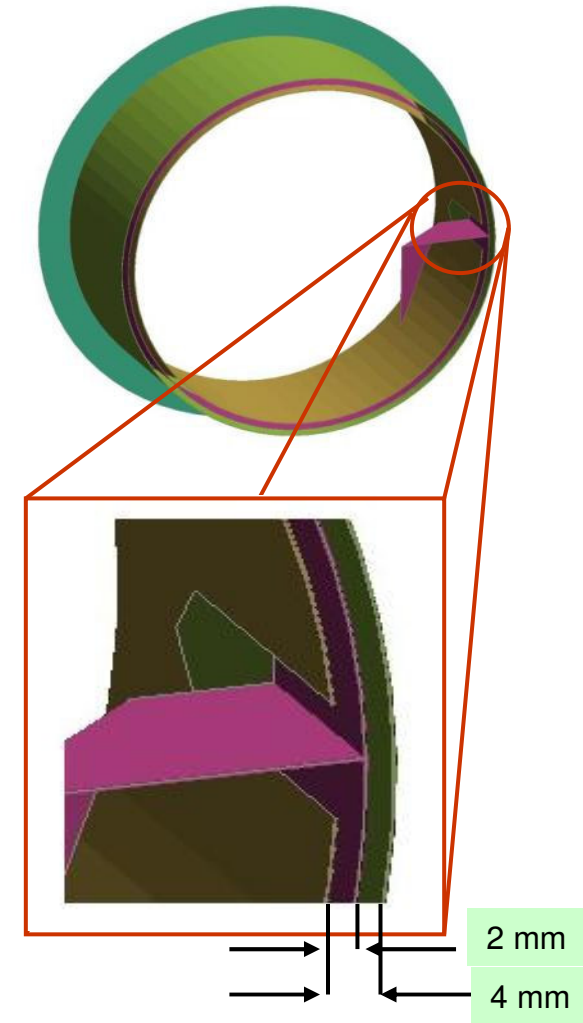

Modelling of Dynamic Safety Vent (DSV)

- As shown, JLR's approach has been to try to accurately represent the DSV.
- This has been a challenge due to high levels of deformation and contact requirements.

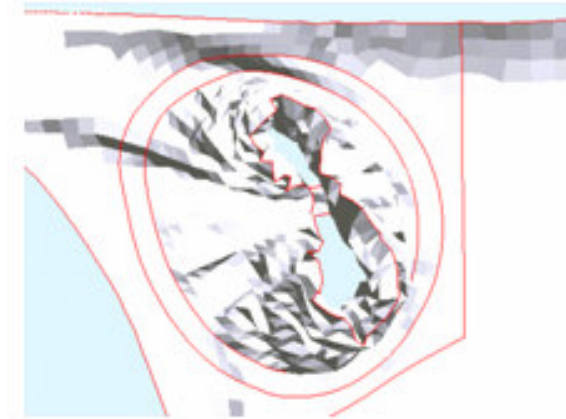

CUSHION FOLDING
REPLICATING THE ACTUAL AIRBAG
FOLDING PROCESS IN CAE

PAB Folding Process

- The folding (and therefore unfolding) is one of the most important parameters to control the PAB deployment and OOP performance.
- The PAB used in this research is scrunch folded i.e. there is no regular origami (folding pattern)
- The manufacturing folding process was carefully studied in order to be accurately represented in the CAE environment

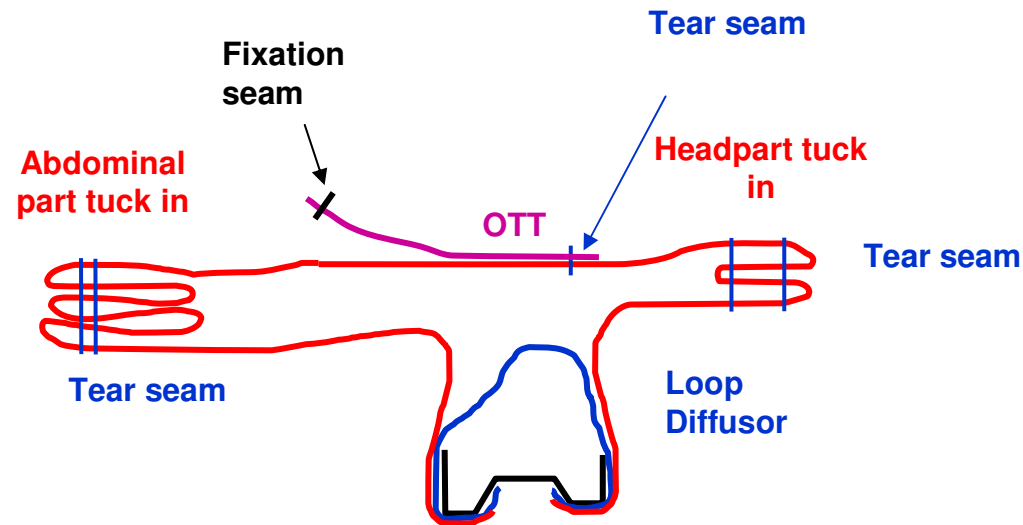

PAB Folding Process – Step 1



During the actual folding the flat PAB is hung upside down to fix the outer tearing tether (OTT)

Folding Abdominal Section

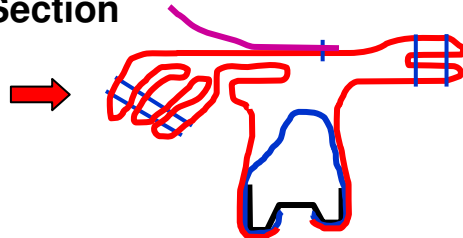

Fixing OTT

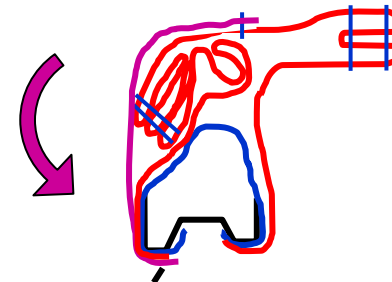

In CAE, this step was replicated by folding the abdominal section first and then fixing the OTT.

PAB Folding Process – Step 2

After the OTT is fixed the PAB is place on the rig and the head portion is flipped over to the left side – leaving the DSV (Dynamic Safety Vents) uppermost

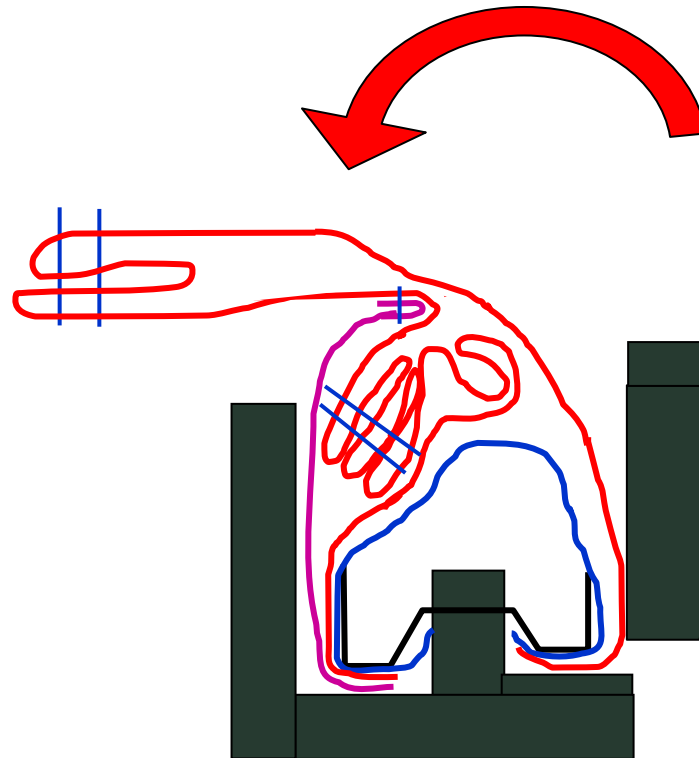

PAB Folding Process – Step 3

The rig has pushers that carry out the crunch folding in order. Longitudinal and horizontal foldings are carried out first. Finally the vertical member pushes the PAB inside the container, ready to be wrapped using the fabric cover.

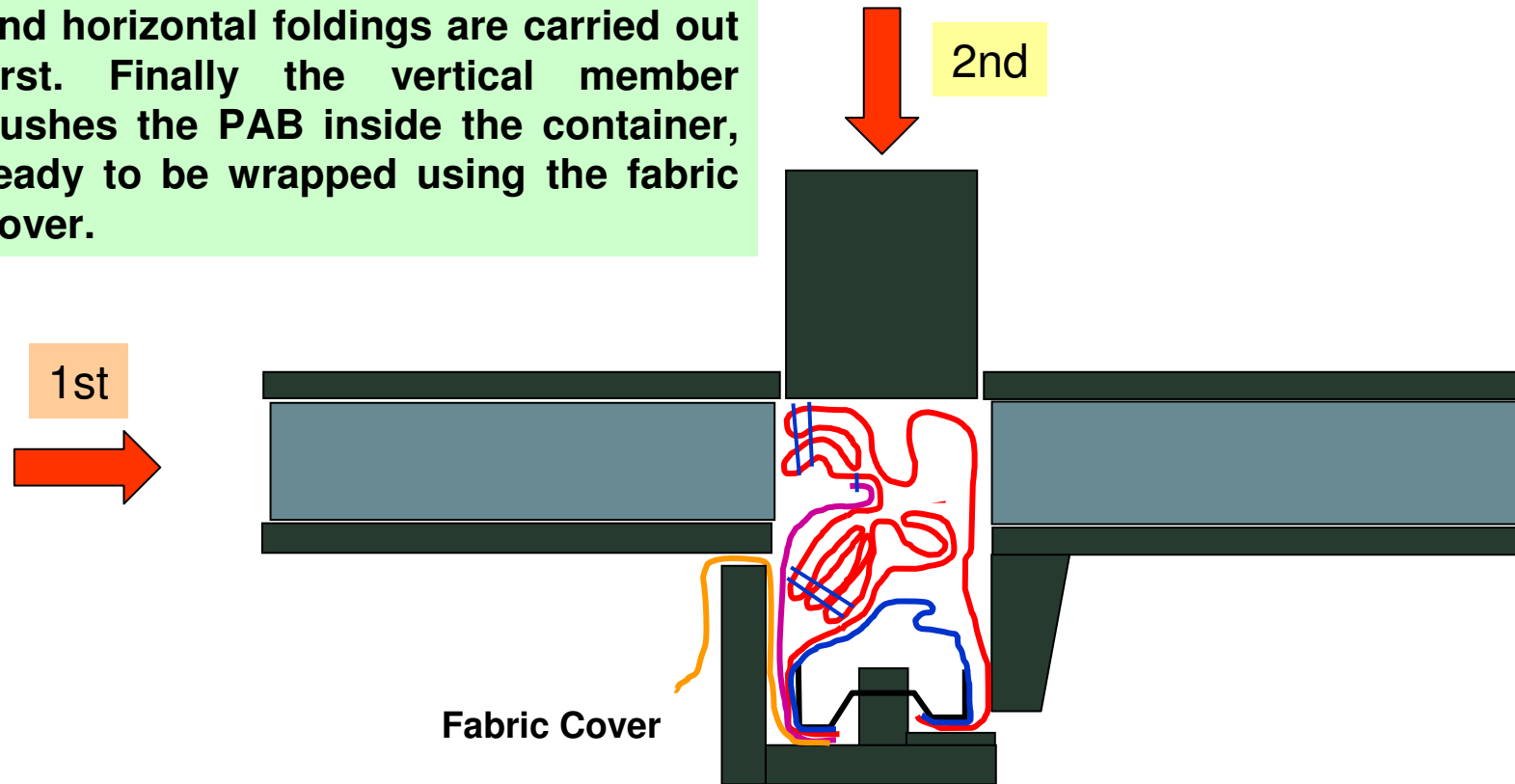

PAB CAE Model Folding Process

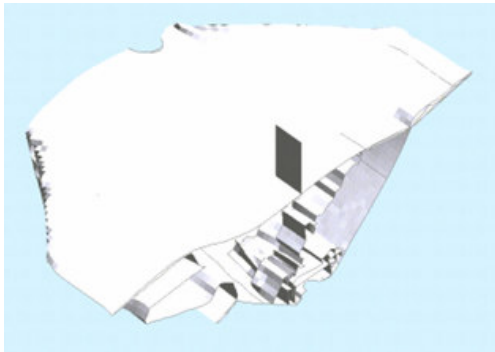
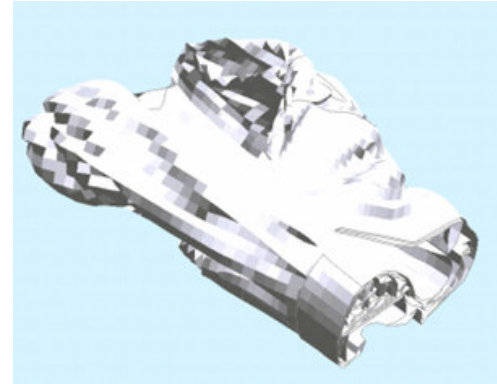
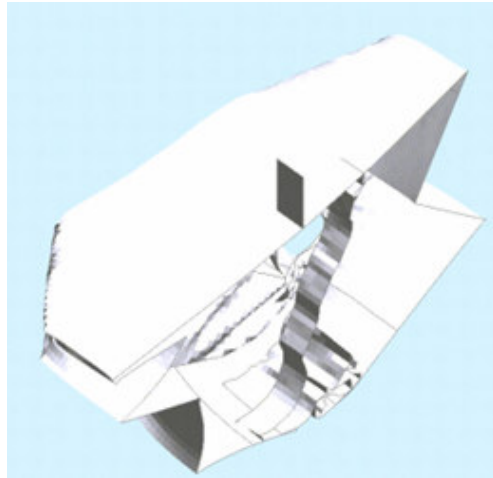
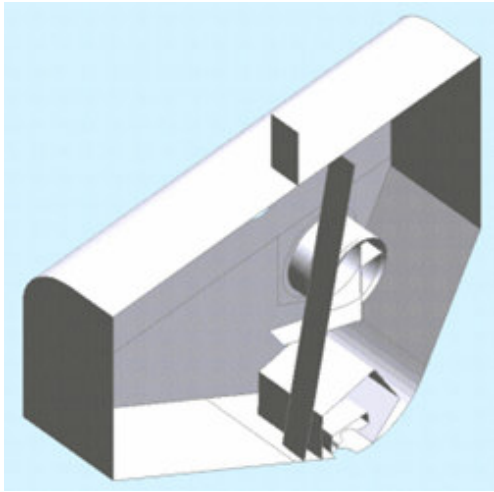

CPM inflation of folded airbag

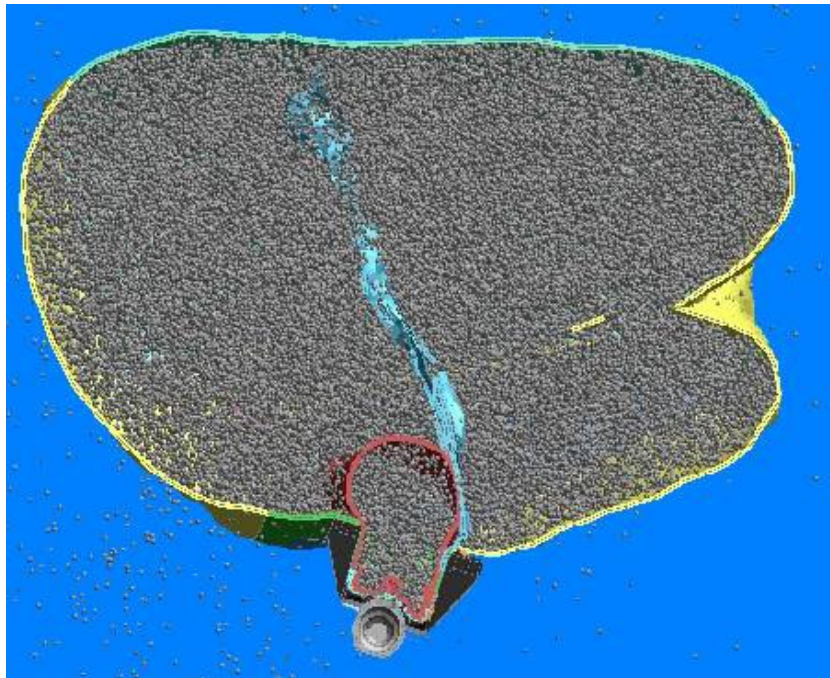
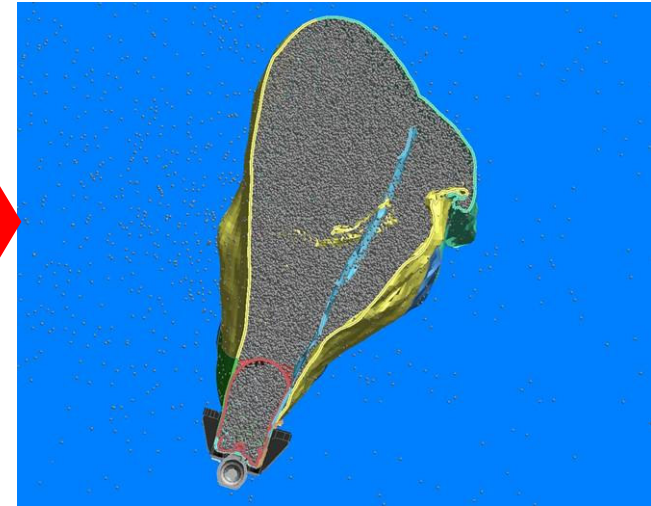
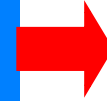
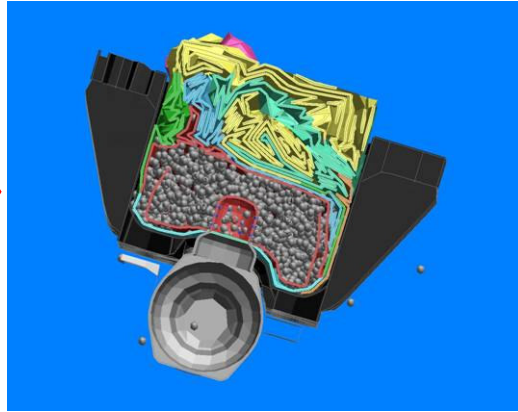
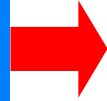
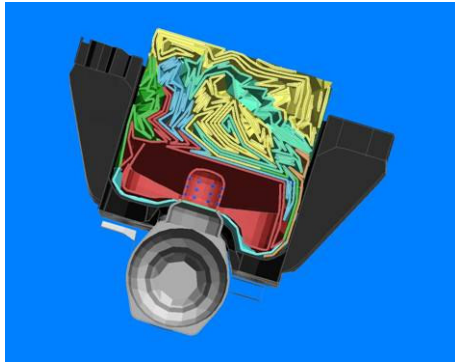

**MODEL CORRELATION
USING LINEAR IMPACT RIG TESTING**

Correlation Matrix

PAB CAE correlation Test Matrix

PAB Test	Impact or	Velocity	Test rig	Passive Vent	safety Vent	Comments
Static Deployment	-	-	COP	45 mm	Yes	Static Deployment
stage one only	35KG	5.5m/s	COP	50 mm	Yes	Stage One Only
stage one only	35KG	5.5m/s	COP	50 mm	Yes	As above repeat test
Safety Vent Only	35KG	7.5m/s	COP	No	Yes	Main Correlation Driver
Safety Vent Only	35KG	7.5m/s	COP	No	Yes	
Passive Vent	35KG	7.5m/s	COP	45 mm	Yes	
Passive Vent	35KG	7.5m/s	COP	45 mm	Yes	
Passive Vent	35KG	7.5m/s	COP	50 mm	Yes	
Passive Vent	35KG	7.5m/s	COP	50 mm	Yes	
Passive Vent	35KG	7.5m/s	COP	55 mm	Yes	Impactor bottoms out
Passive Vent	35KG	7.5m/s	COP	55 mm	Yes	Was not carried out
Reverse Test 1	20KG	0.0m/s	COP	45 mm	Yes	Reverse Test
Reverse Test 2	20KG	0.0m/s	COP	45 mm	Yes	Reverse Test (partial deployment)

Model Correlation

- The correlation of the PAB was done using five linear impact and reverse test load cases.
- An LS-OPT optimisation was performed to find the set of input variables which provided the best possible correlation to all load cases
 - inflator power
 - Safety vent efficiency
 - Standard vent efficiency
 - Fabric porosity

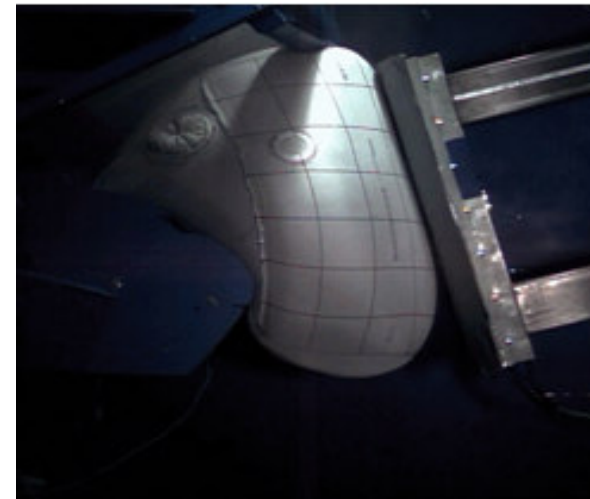
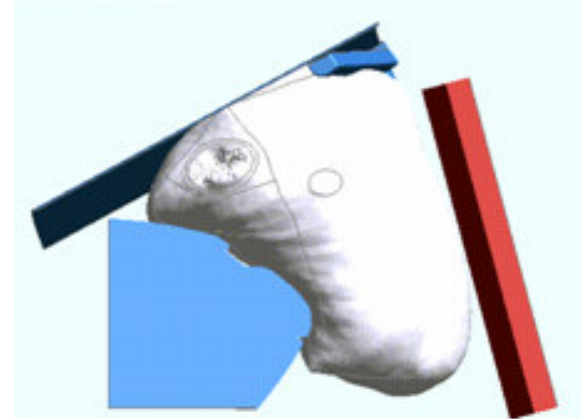

First Stage Only Correlation – LC2

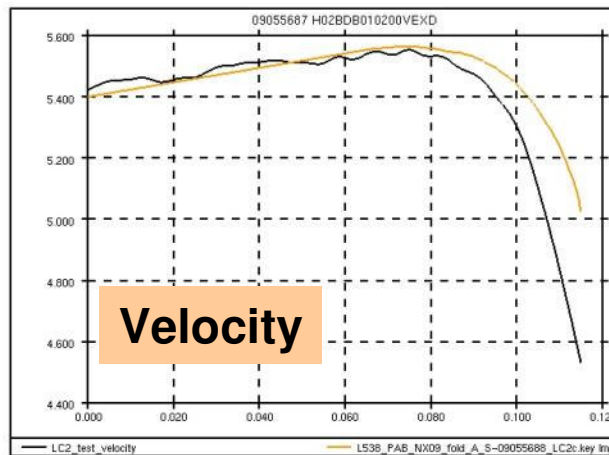
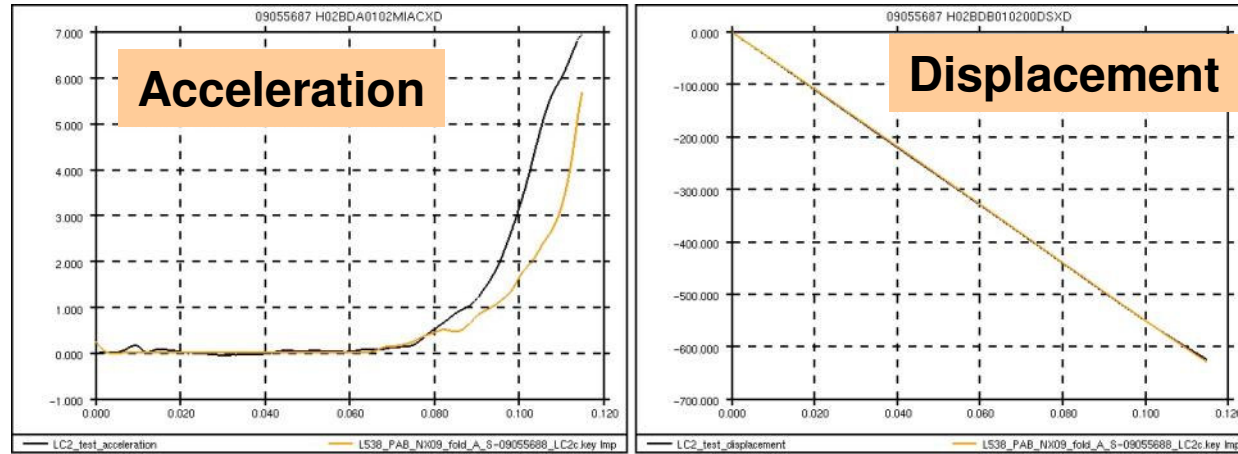

Dynamic Safety Vent Only – LC3

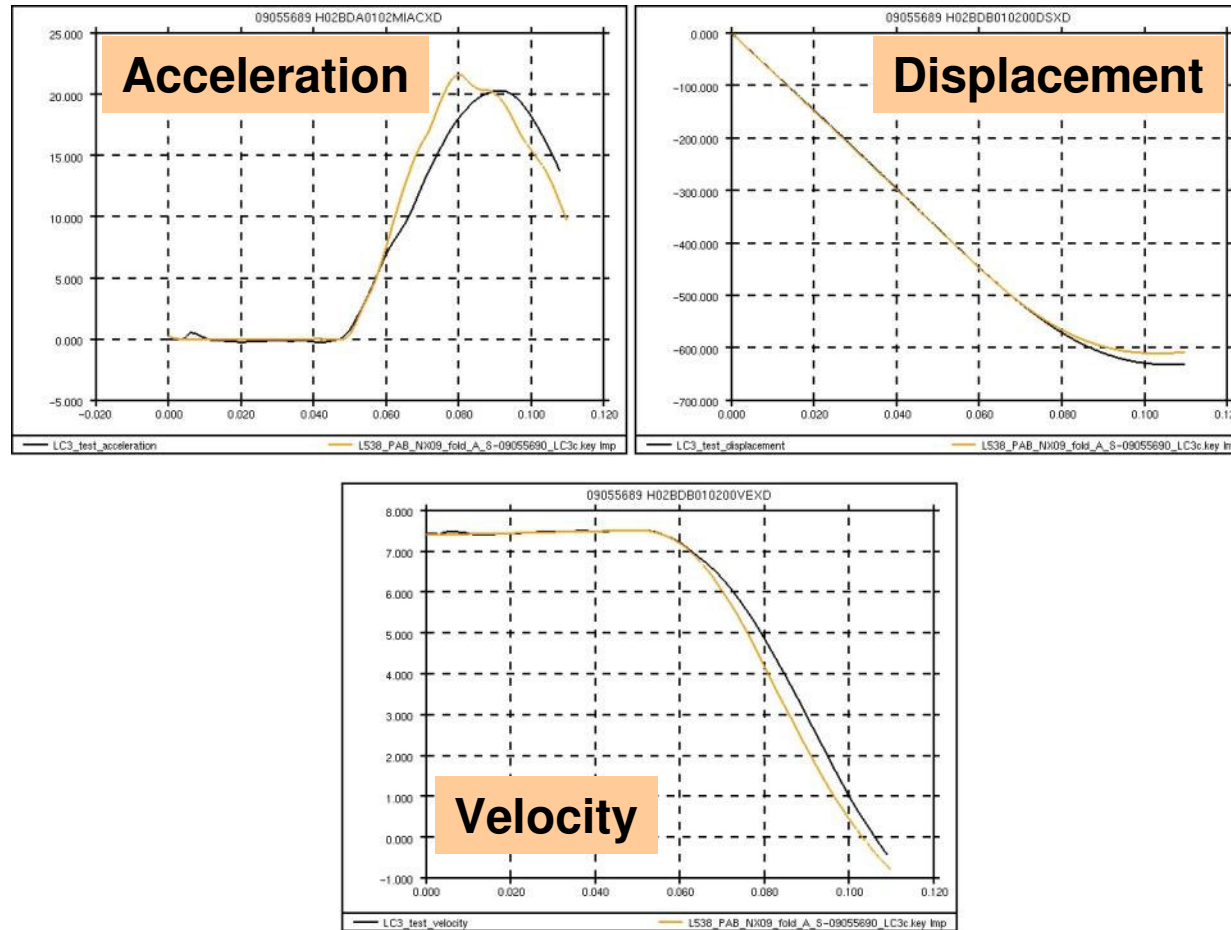

Passive Vent 45 mm – LC4

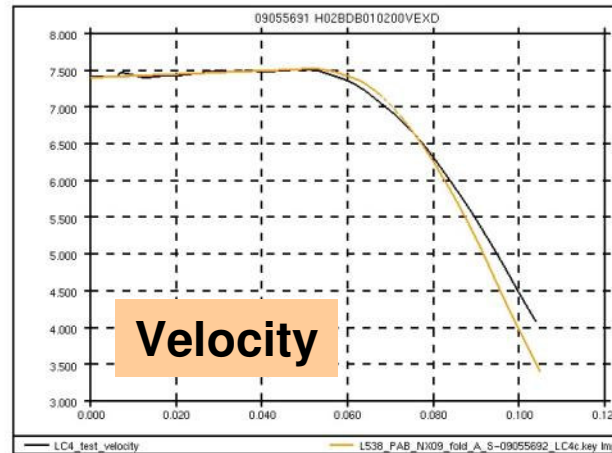
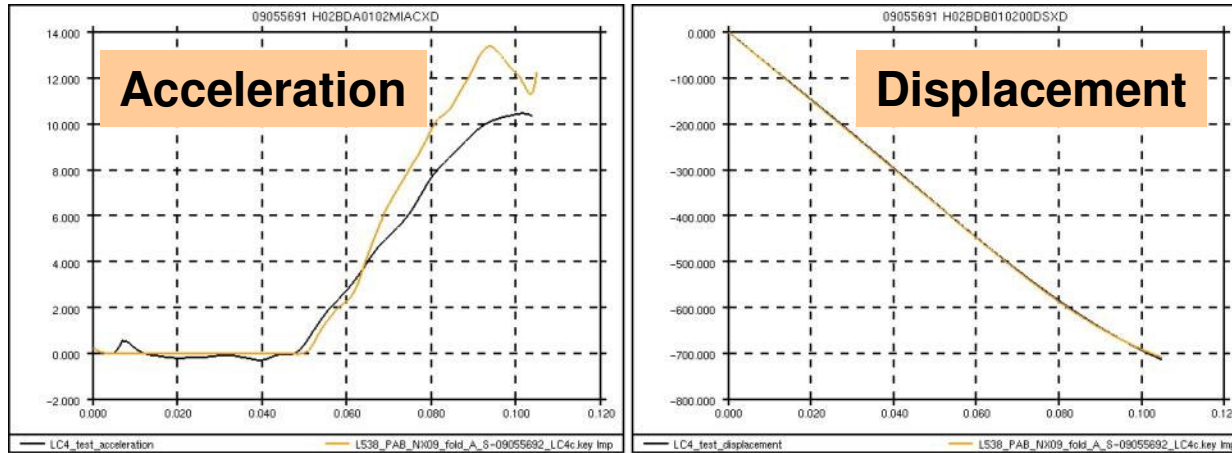

Passive Vent 50 mm - LC5

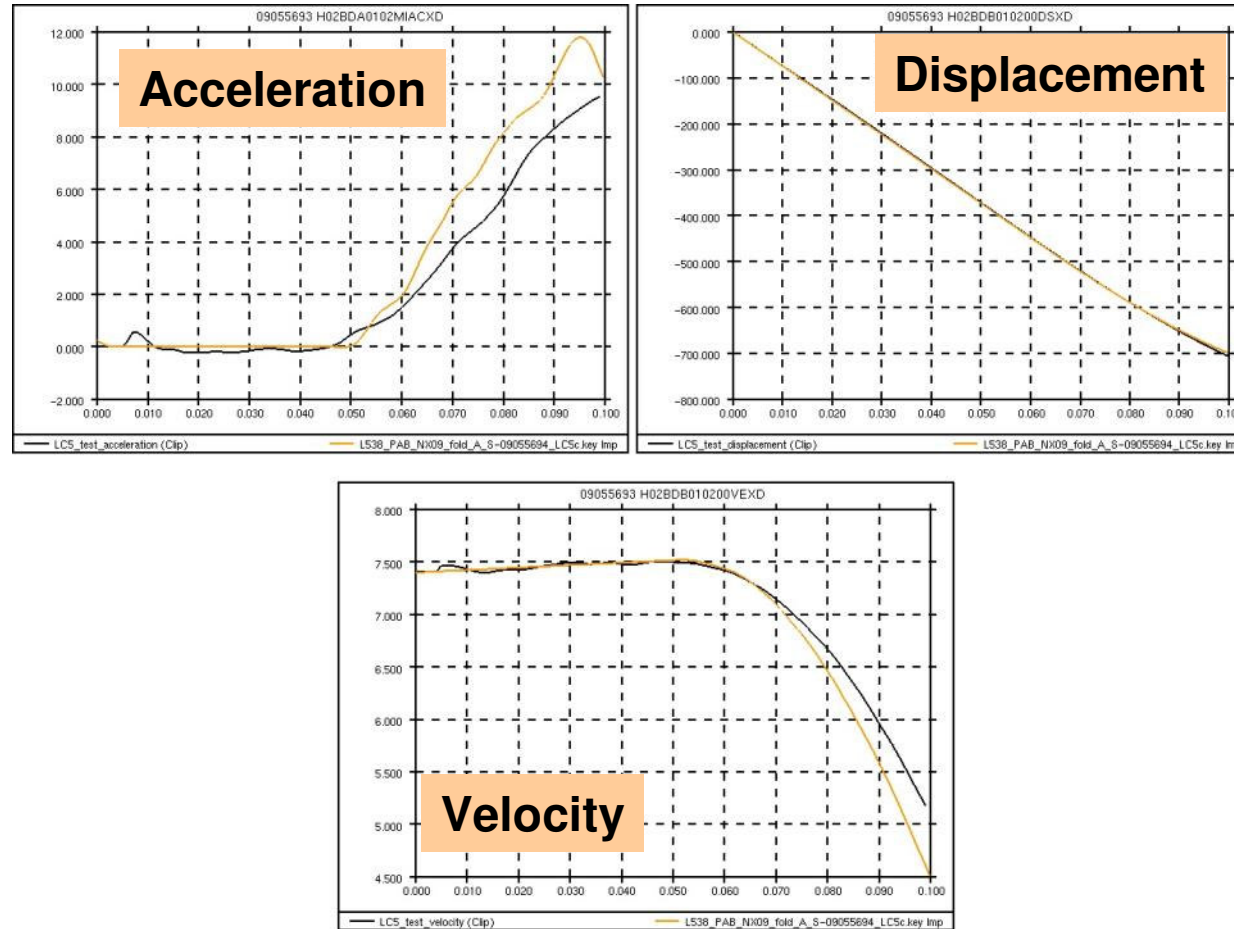

Pareto Optimal

- Statistical tools were used to identify the value of the considered input variables that produced the best correlation for all these loading cases simultaneously.
- The considered Variables were:
 - Temperature
 - Static Vent Efficiency
 - DSV Efficiency
- The output was treated as a Composite Response for which the following impactor responses were used to create a correlation score
 - Displacement
 - Velocity
 - Acceleration

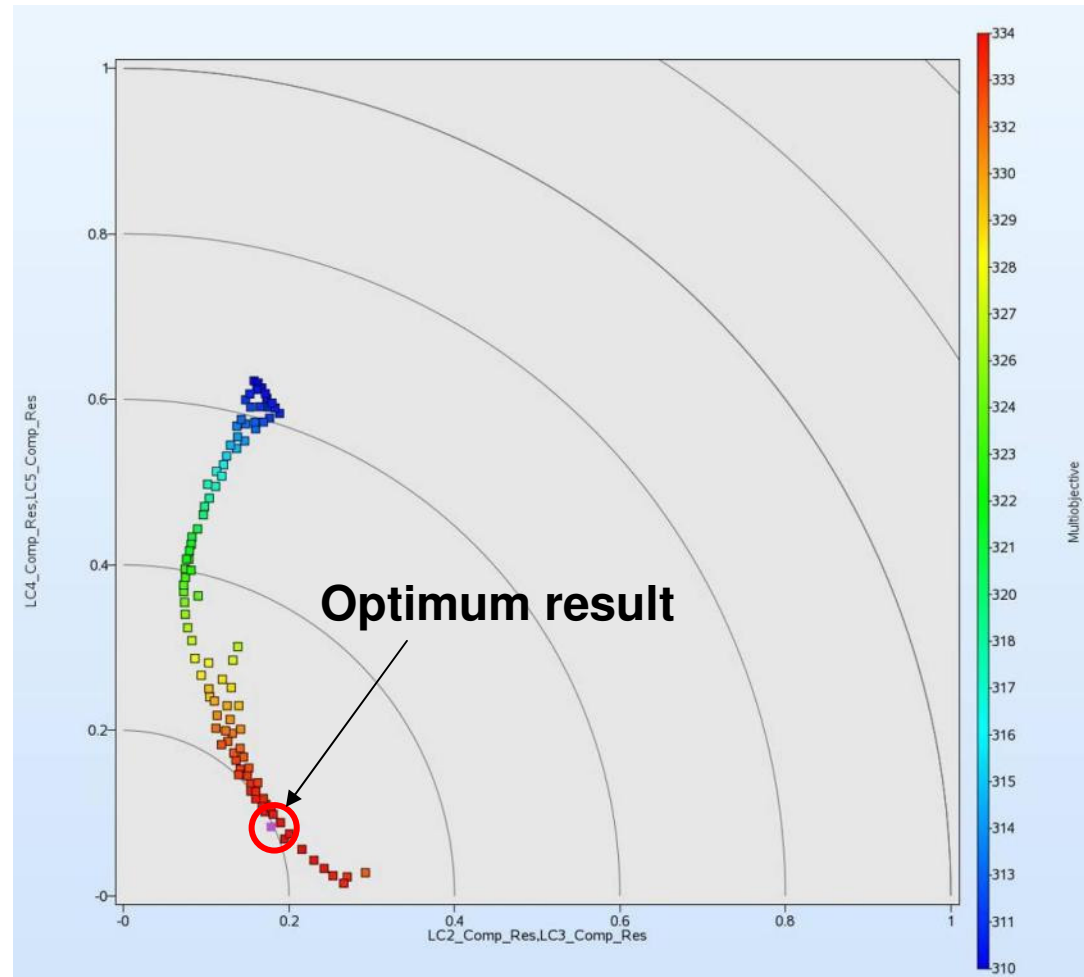

ROBUSTNESS ANALYSIS
PERFORMED ON FULL SIMULATIONS OF
NHTSA OOP TESTS



NHTSA Loading Cases

NHTSA Pos. 1

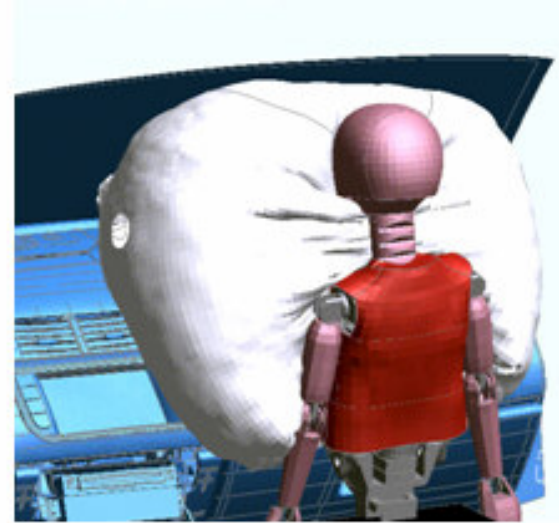
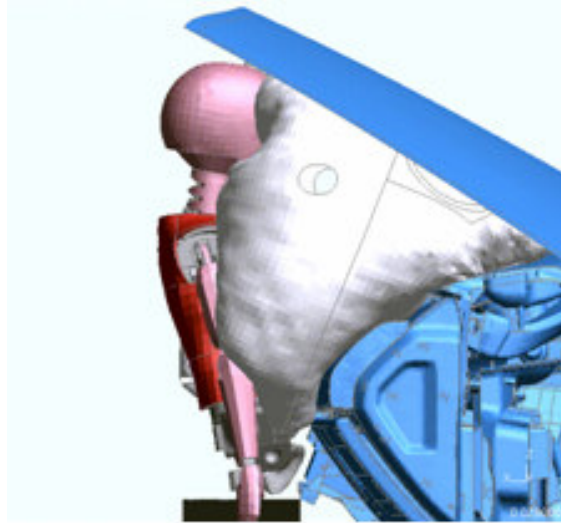

NHTSA Pos. 2

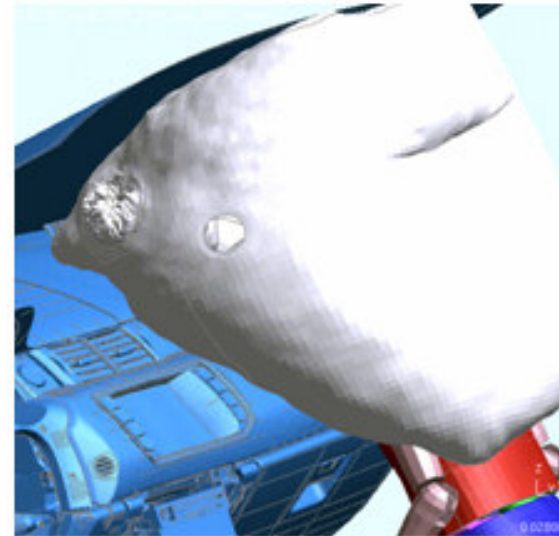
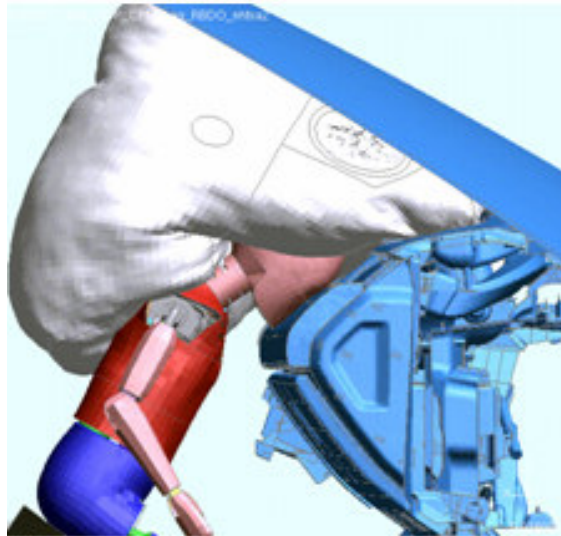

Robustness Analysis - Overview

- Robustness analysis was undertaken to determine the variability in performance of the NHTSA positions 1 and 2 tests due to variable input conditions.
- A total of 13 variables were used for this study.
- A total of 100 runs per study were used to generate Meta-models of the responses.
- The robustness analysis was carried out using the meta-model. A total of 10,000 points or more can then be used to generate the necessary statistical data.

Robustness Analysis – Assumed noise distribution

- The robustness analysis requires the specification of a Probability Distribution Function (PDF) for the noise. A normal distribution was assumed for all the variables, except for the bag folding.
- The selected ranges correspond to the 3 Sigma deviation from the nominal or mean value.
- The bag folding was treated as a discrete variable. This was necessary due to the manual folding process and the time required to produce the a folded bag. Three bags were used in this study

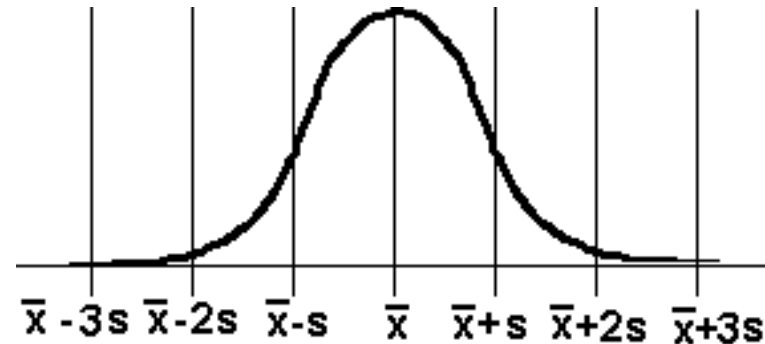

Robustness Analysis – PAB Folding variability

- The folding variability concentrated mostly on the final position of the DSV.
- The supplier suggested that this is an uncontrolled parameter.
- This variability was included to investigate its influence on the results.

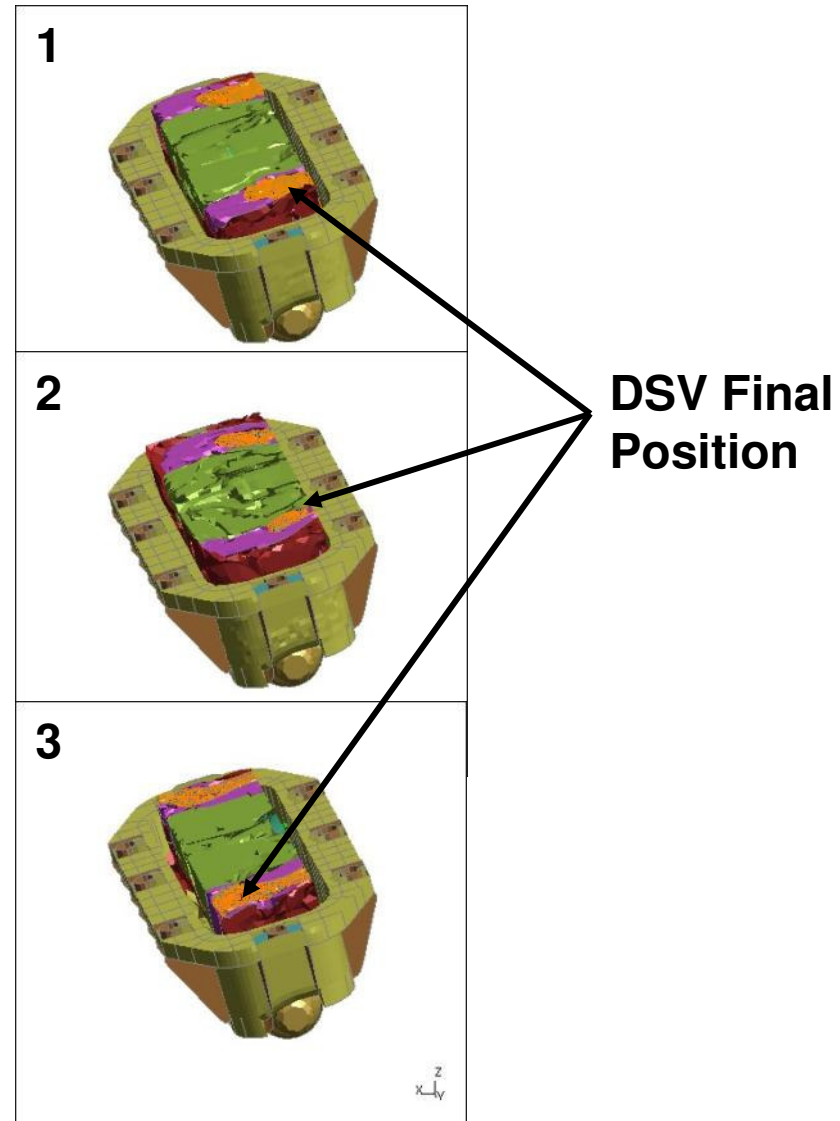

Robustness Analysis – Tether Length Control

- The tether active length, for the chest and DSV, was controlled by dividing it in two sections. The main section was modelled using shell elements and the last 50 mm were modelled using seatbelt elements.
- This modelling approach provides the flexibility to change the active length of the tether by specifying the payout length of the belt element.

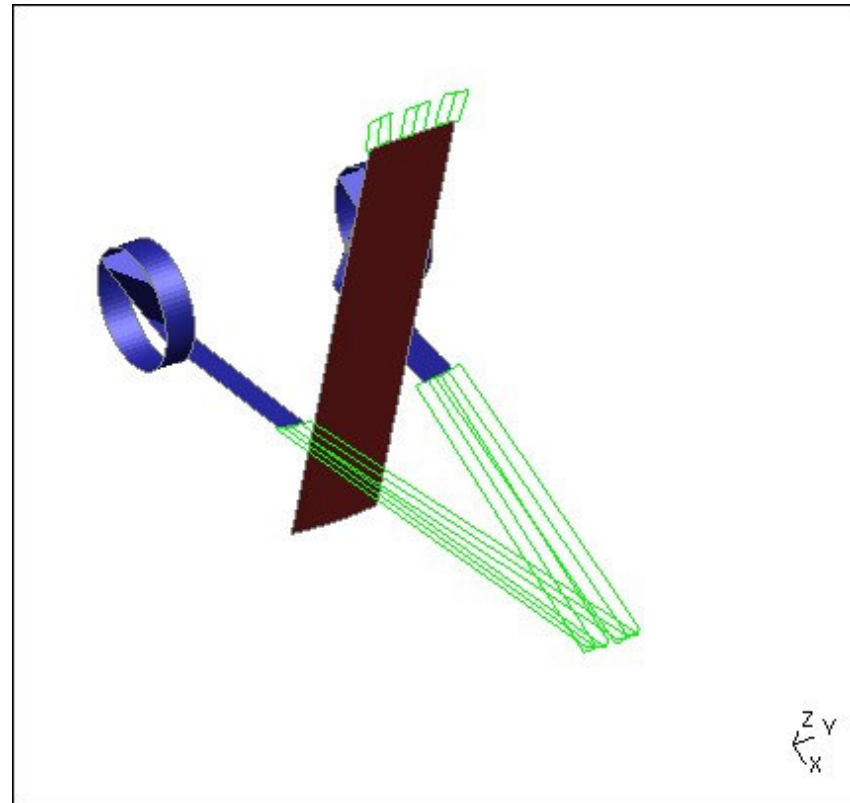

Robustness Analysis – NHTSA Positions 1 & 2

e.g. HIC Correlation Plot

- This graph shows the correlation between the input variables and the HIC response.
- A correlation graph provides at least two important pieces of information, namely:
 - How linear is the relationship between an input variable and a given response.
 - If the relationship between the input variable and the response is positive or negative.
- A positive correlation indicates that an increase in the input variable will cause an increase of the response.
- A negative correlation indicates that an increase in the input variable will cause a decrease of the response.

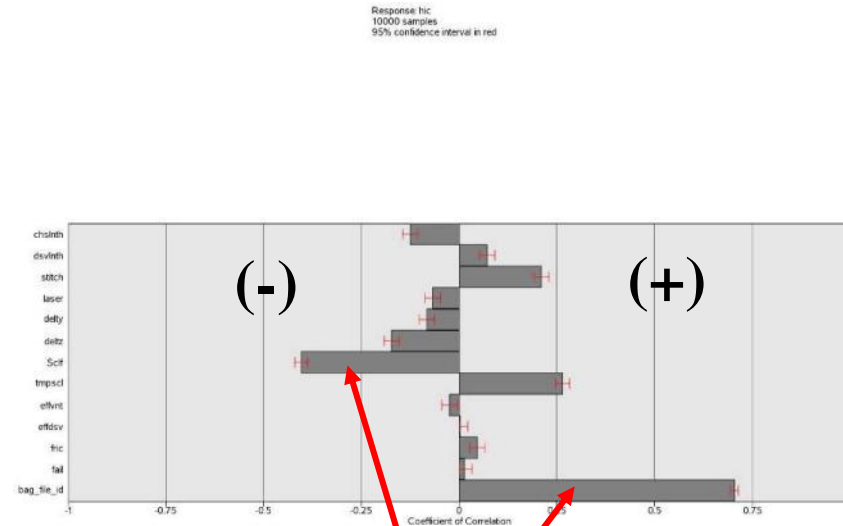

e.g. HIC response to bag's folding is linear and positive while the response to volume changes is not as strongly linear and negative

Robustness Analysis – NHTSA Positions 1 & 2

Probability Distribution

- Statistical distribution for the considered responses was established.
- Distribution plots were used to highlight areas of concern e.g. Responses with mean value or standard deviations that are too close or over the acceptance criteria.

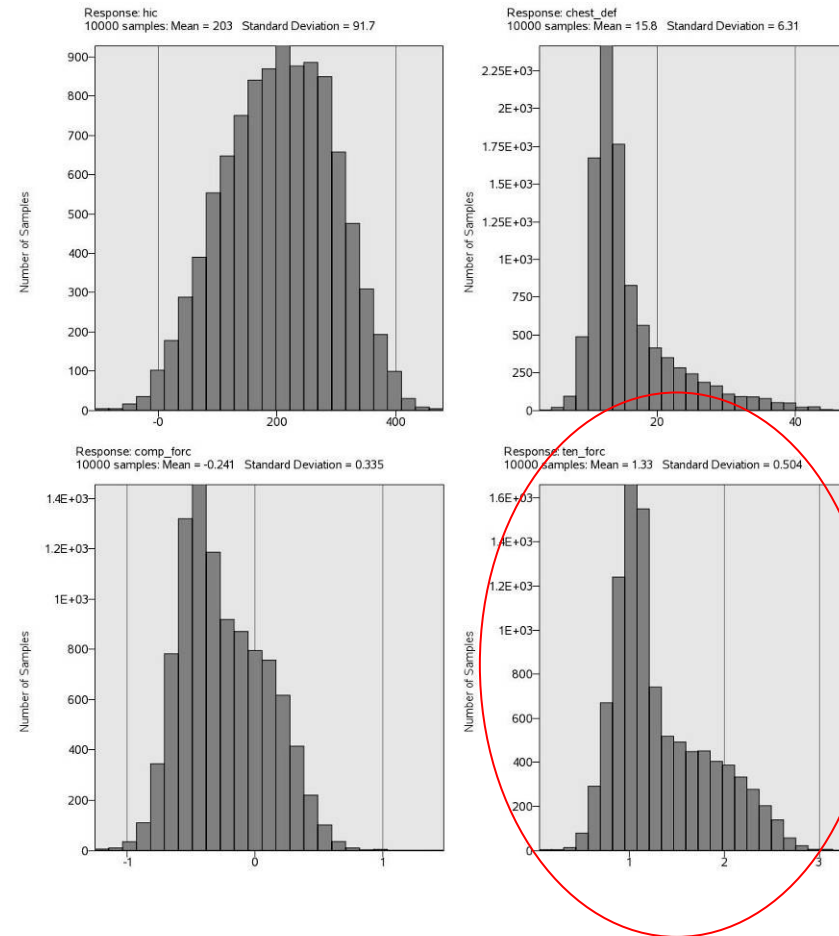

Robustness Analysis – NHTSA Positions 1 & 2

Sensitivity Analysis e.g. HIC

Global Sensitivities Plot for hic
Mean = 289.08, Total variance = 4223.91, Noise variance = 2192.53

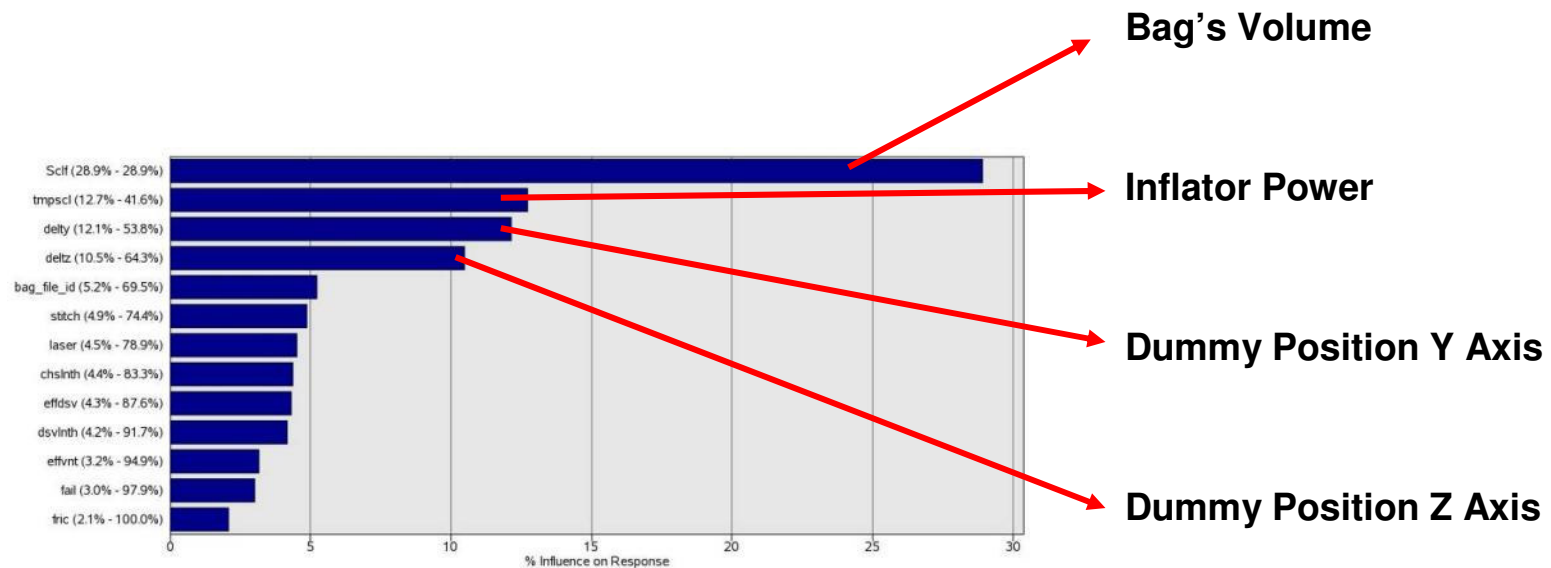

e.g. These four variables account for more than 60 % to the HIC variability

Robustness Analysis – NHTSA Positions 1 & 2 Sensitivity Summary

- The summary sensitivity analysis shows the variables, in importance order, that can be used to control or improve the robustness of the process.

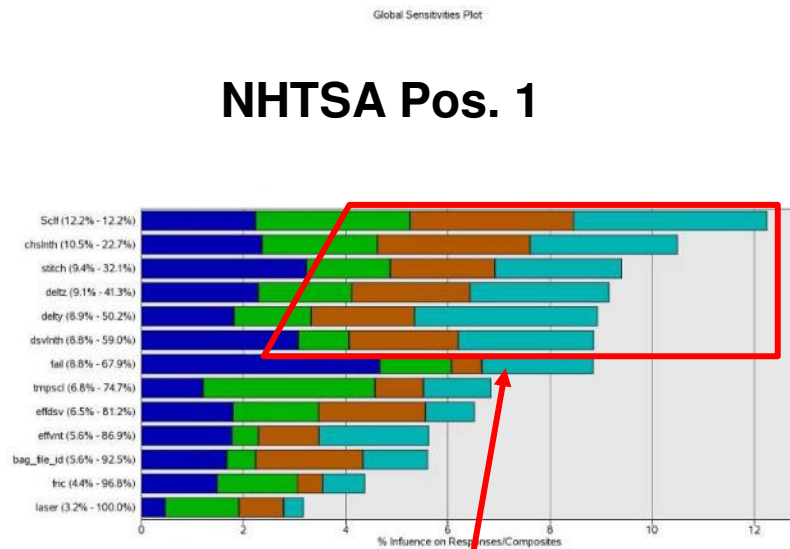

Top 6 control parameters

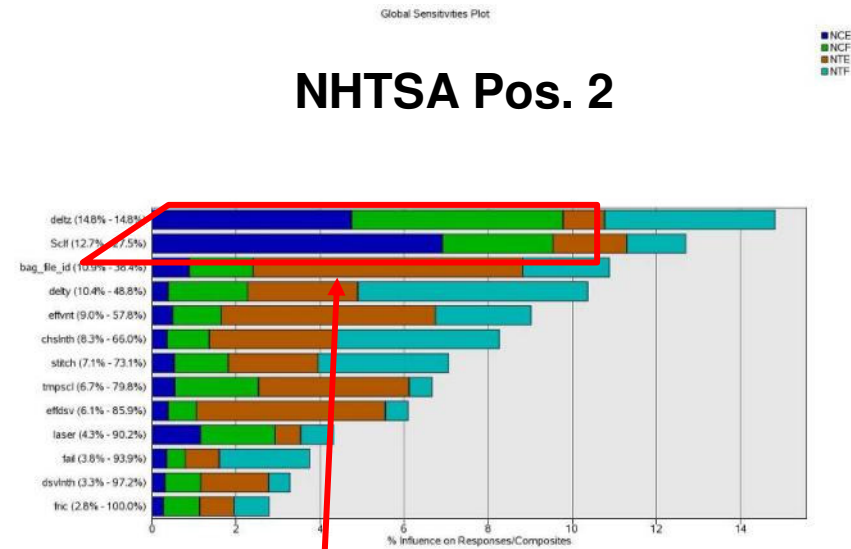

Top 2 control parameters

Robustness Analysis – NHTSA Positions 1 & 2

Parallel plot of Responses

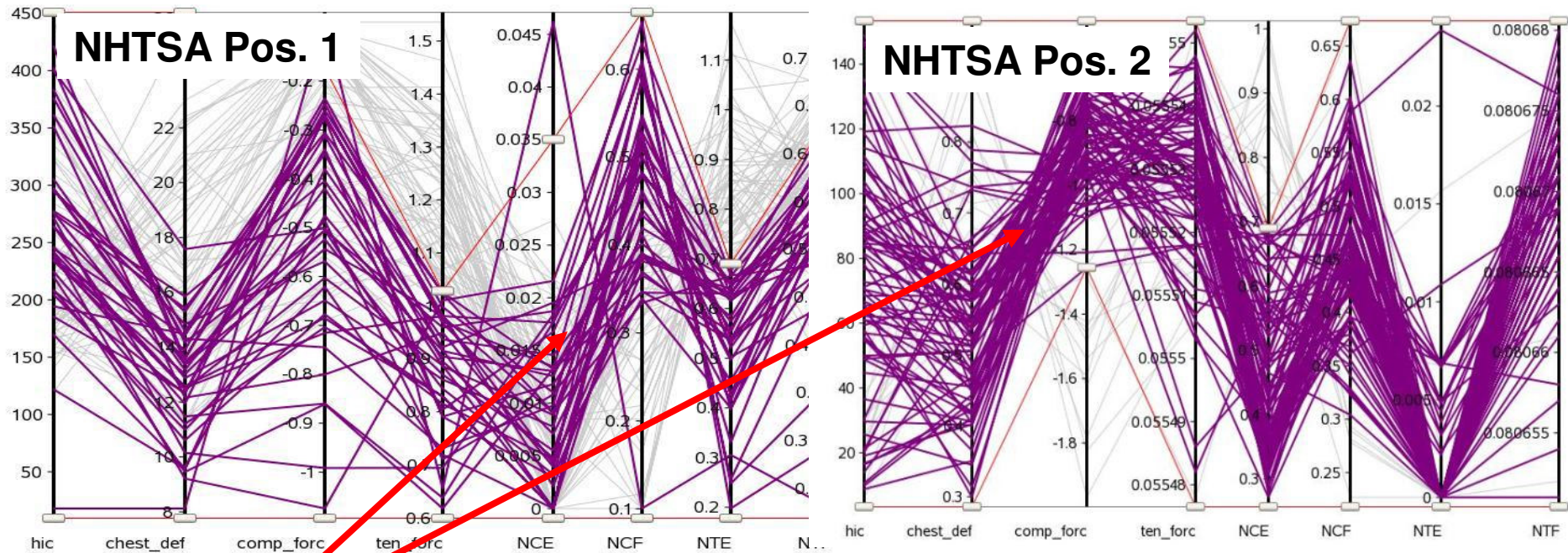

**Results that
comply with
Design
Criteria**

**The ability to filter results allows the
parallel plot to highlights only a group
of solutions which meet certain criteria**

Verification NHTSA Position 1



Verification NHTSA Position 1

HIC

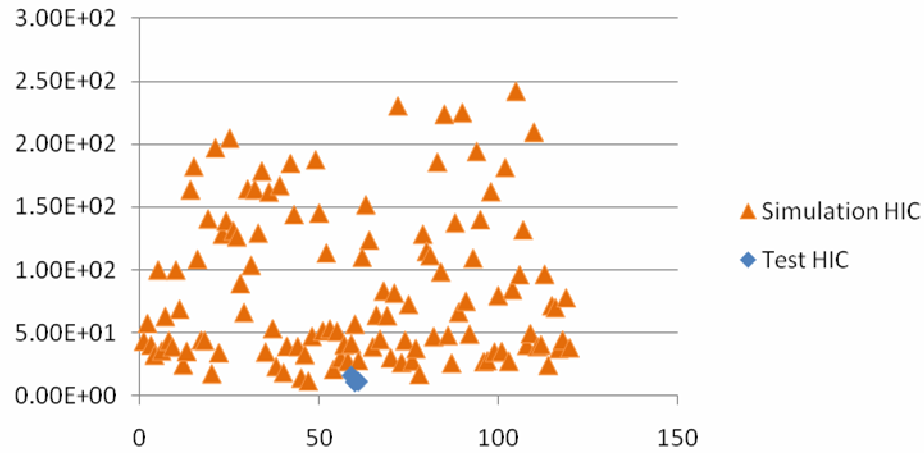

Chest Deflection

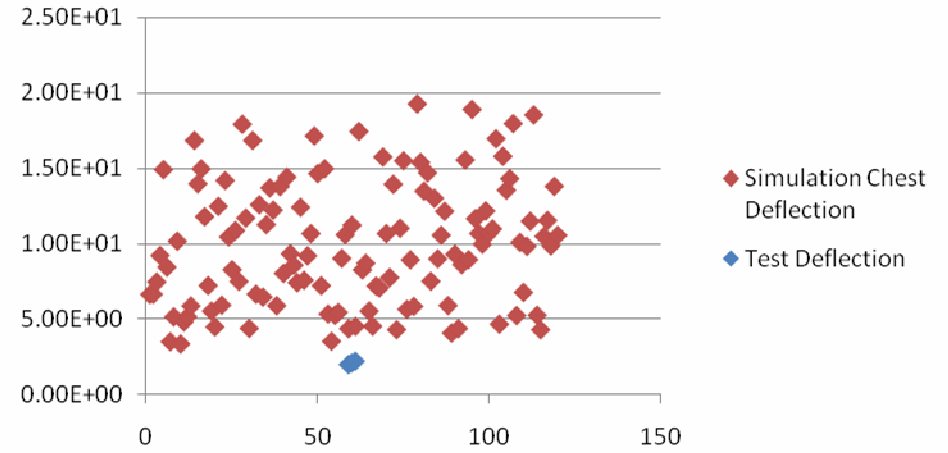

Compression Force

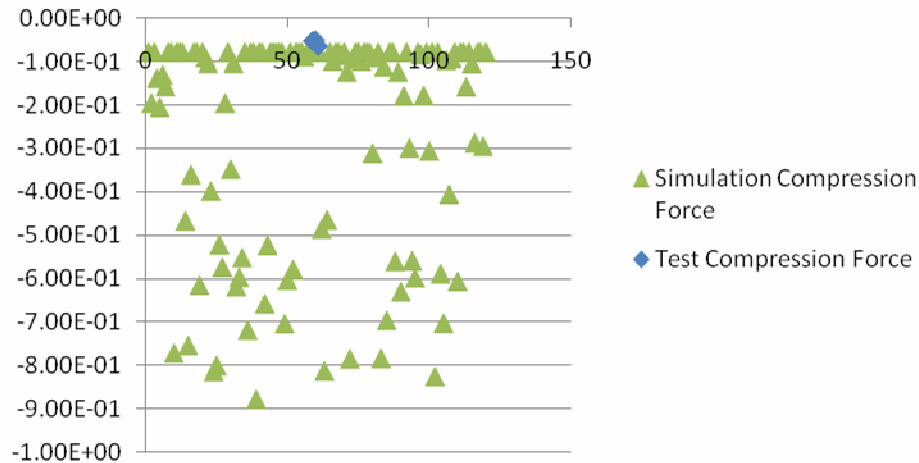

Tension Force

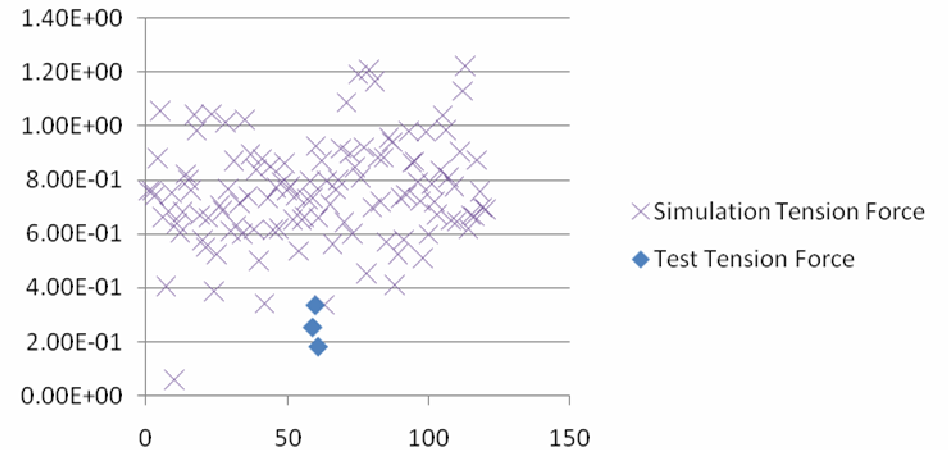

Verification NHTSA Position 1

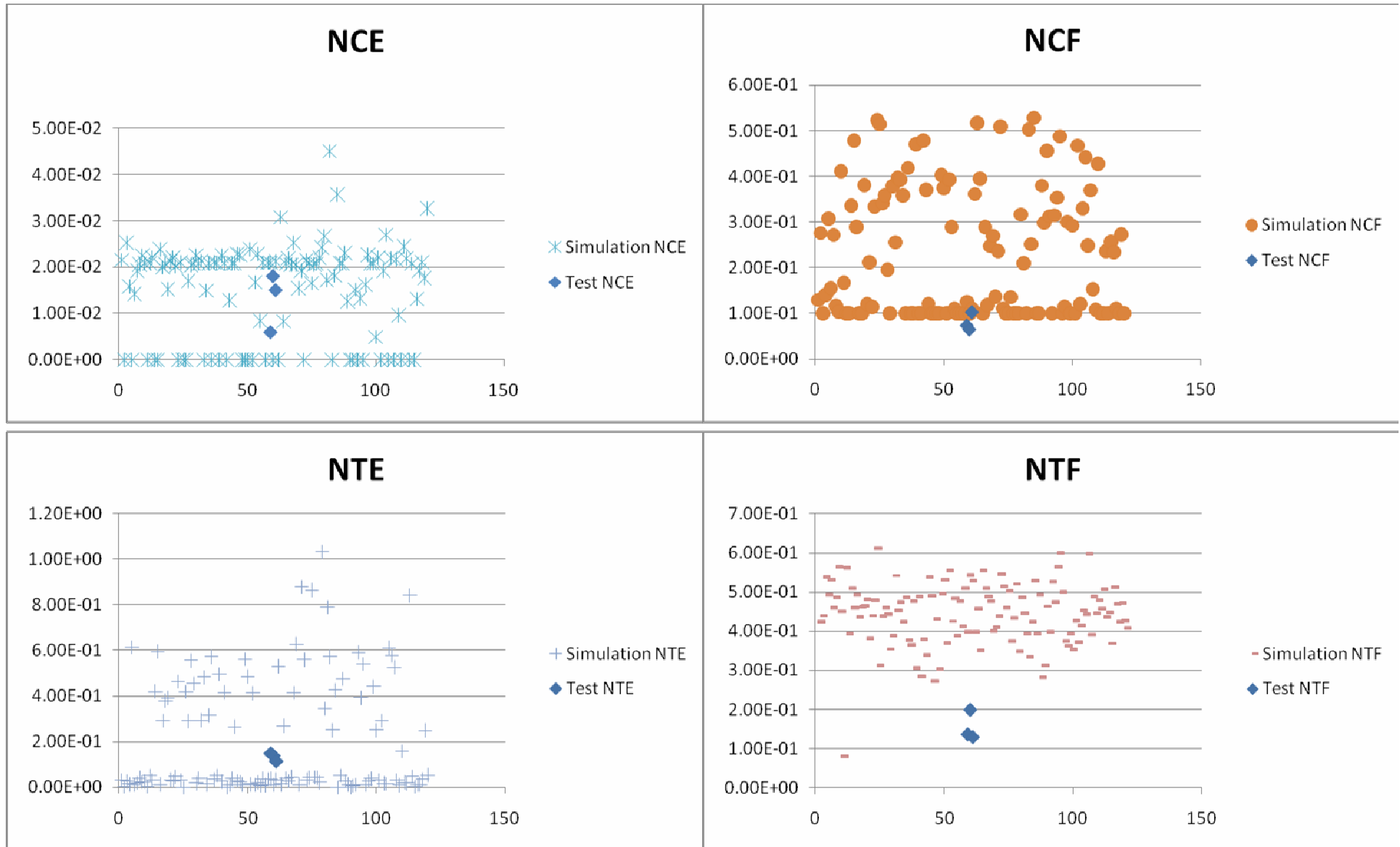

Verification NHTSA Position 2



Verification NHTSA Position 2

HIC

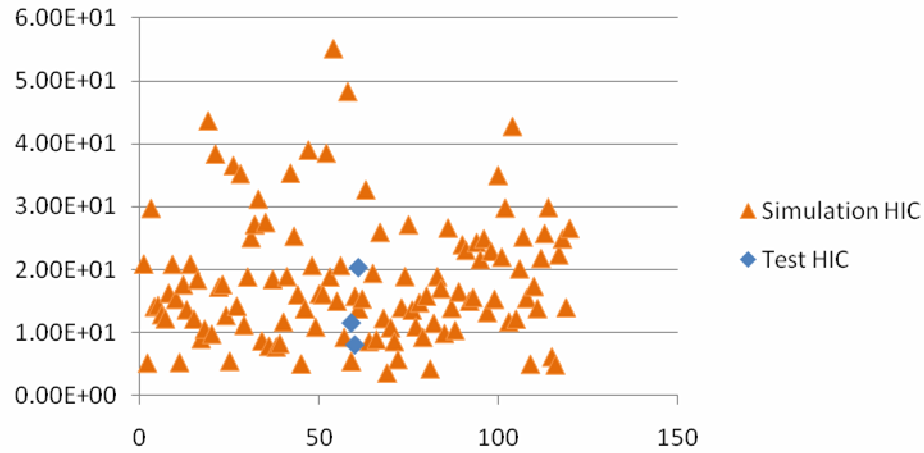

Chest Deflection

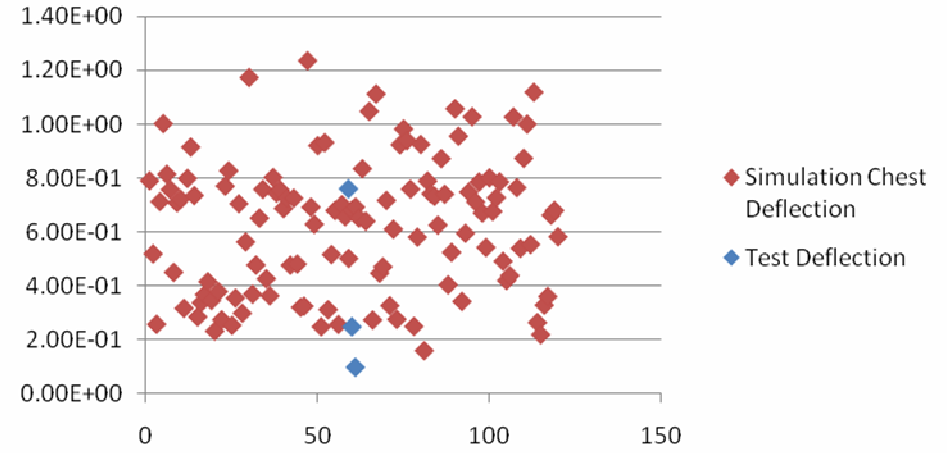

Compression Force

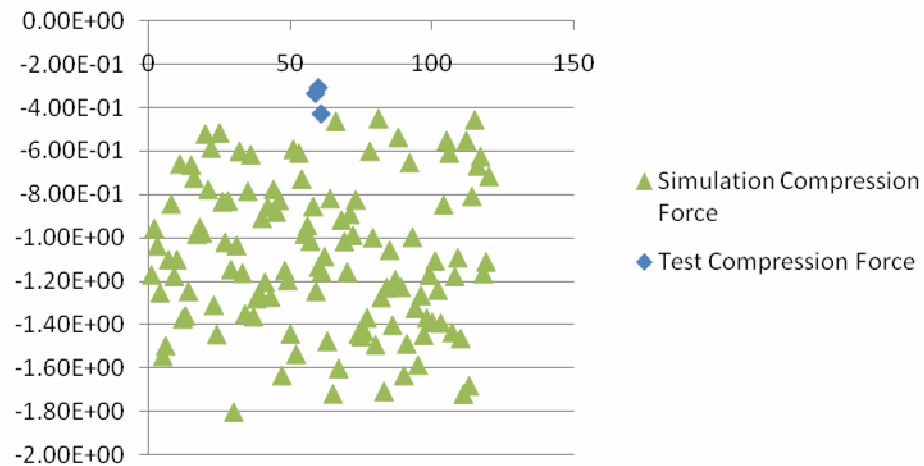

Tension Force

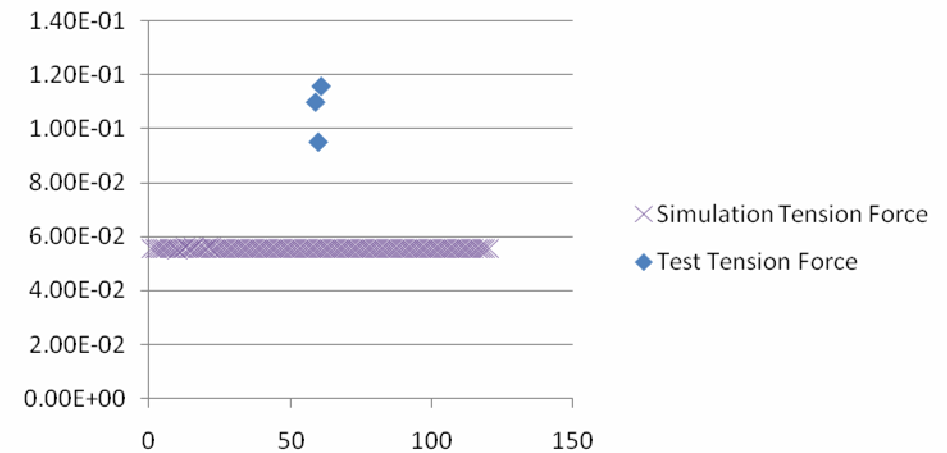

Verification NHTSA Position 2

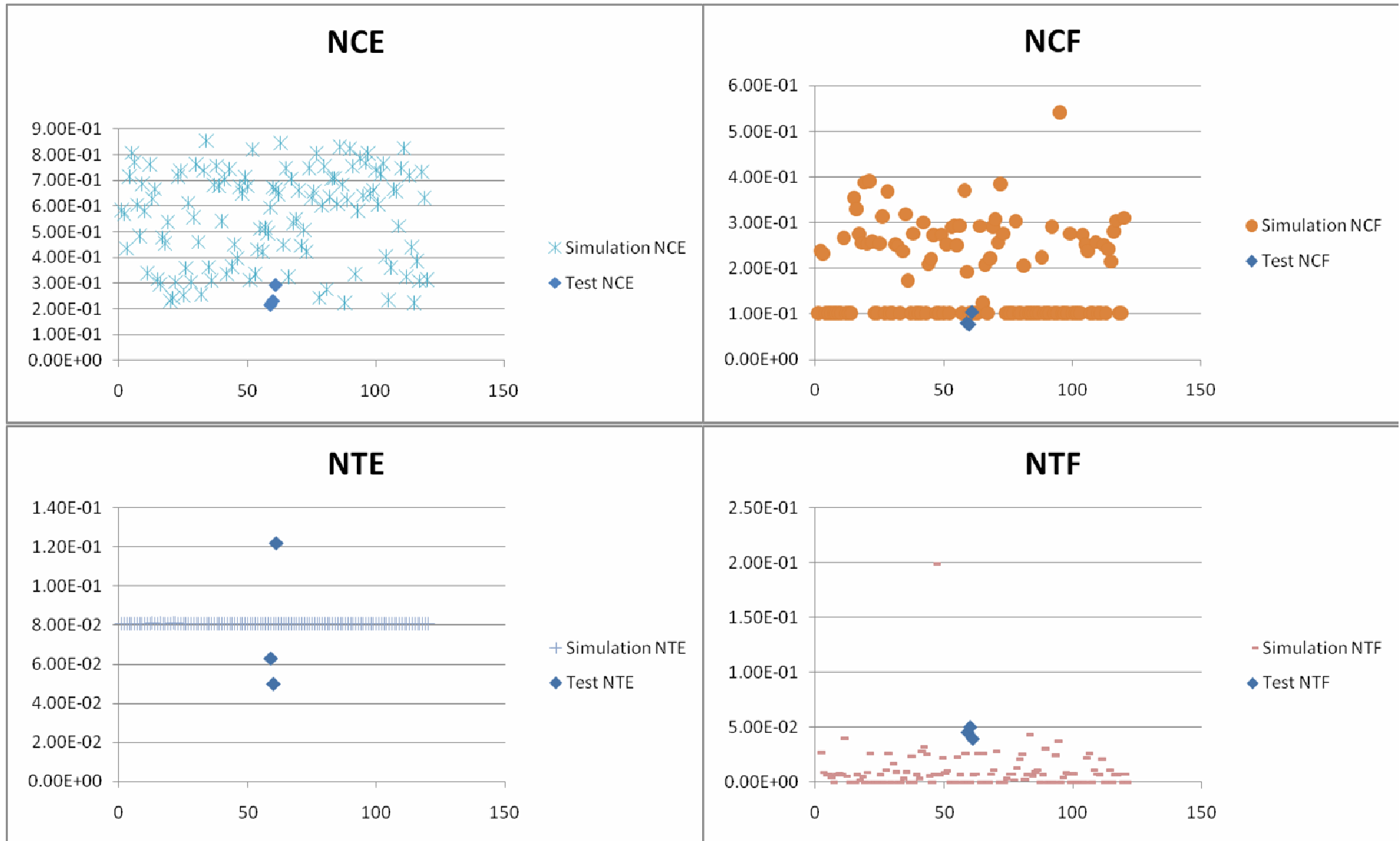

Conclusions

- LS_DYNA can be used for reliably capturing and replicating the actual folding of the complex PAB . [One Code for OOP](#)
- Ls_dyna Particles Method provides a realistic opportunity to investigate OOP performance alongside standard In Position performance with one and the same model. [Particle method](#)
- Many technical challenges have been overcome (e.g. bag folding and modelling of the dynamic safety vent) and the resulting model is now fully parametric. Tether length, venting efficiency, porosity, etc are all variable and allowing for further investigation using stochastic techniques. [LS_DYNA JLR right code of choice](#)
- The CAE based robustness analysis was used to identify those responses that propose a risk to the design. This methodology shows those parameters that can be used to better control the performance of the system [CAE Drive design](#)