

ANSYS

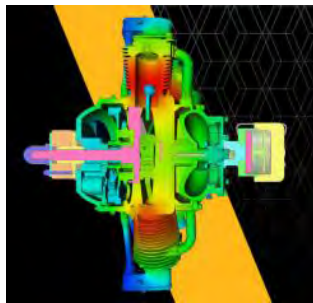

LST

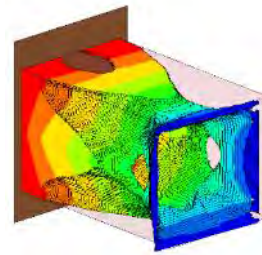

OASYS



Predictive Engineering



LS-DYNA® New Feature and Application

Constrained Multidisciplinary Topology Optimization



FEA Information Engineering Solutions

www.feapublications.com

The focus is engineering technical solutions/information.

FEA Information China Engineering Solutions

www.feainformation.com.cn

Simplified and Traditional Chinese

The focus is engineering technical solutions/information.

Livermore Software Technology, an ANSYS company

Development of LS-DYNA, LS-PrePost, LS-OPT,

LS-TaSC (Topology), Dummy & Barrier models and

Tire models for use in various industries.

www.lstc.com

To sign up for the FEA News send an email - subject "subscribe" to news@feainformation.com

To be removed from the FEA News send an email - subject "Remove" to news@feainformation.com

If you have any questions, suggestions or recommended changes, please contact us.

Editor and Contact: Yanhua Zhao - news@feainformation.com

Platinum Participants

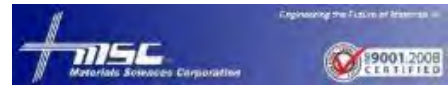
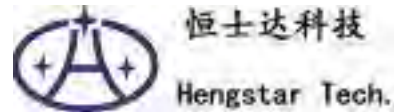

Table of contents

02 FEA Information Inc. Profile
04 TOC

03 Platinum Participants

Articles – Blogs – News

05	ANSYS	Ready for Take Off: Simulation Charges Electric Air Racing
08	BETA CAE Systems	BETA CAE Systems announces the new version v21.0.0 of its software suite and the release of v20.0.5 and v20.1.3
09	d3View	3VIEW Workflow
10	DYNAmore GmbH	Online training offers
11		Webinars and Video-Seminars 2020
12	ESI Group	Driving Change for Vehicle Emission Policies
16	ETA	DYNAFORM Version 6.0
17	FEA Not To Miss	Simulation of the F1 Ferrari
18	Hengstar Technology	Online Training of Application of tire finite element simulation
19	JSOL	LS-DYNA Features
20	KAIZENAT	Kaizen-DYNA App
21	LST	LS-TaSC for Topology and Shape Design
22		LS-TaSC New Release Version 4.2
23	Material-Sciences	Progressive Composite Damage Modeling in LS-DYNA (MAT162 & Others)
24	OASYS	Webinar to watch: Session 2 Deciphering LS-DYNA Contact Algorithms
25		Top Tip video: Multiple Models
26	Predictive Engineering	NASA 5020A - Its All in the Bolt Preload
28	Rescale	Platform Updates and Software Release Notes – September 2020
30	Shanghai Fangkun	Ansys Innovation Conference 2020
32	Terrabyte	Products, Sales, Consulting

Automotive, Resource links, LS-DYNA Training

33	Automotive News - General Motors' Future Electric Vehicles to Debut Industry's First Wireless Battery Management System
35	LS-DYNA – Resource Links
36	Training - Webinars

LS-DYNA New Feature and Application

37	Constrained Multidisciplinary Topology Optimization
----	---

Resources

45	Engineering Solutions	59	ATD - Barrier - THUMS
54	Cloud - HPC Services - Subscription	62	Social Media



About ANSYS, Inc.

If you've ever seen a rocket launch, flown on an airplane, driven a car, used a computer, touched a mobile device, crossed a bridge or put on wearable technology, chances are you've used a product where ANSYS software played a critical role in its creation. ANSYS is the global leader in engineering simulation. Through our strategy of Pervasive Engineering Simulation, we help the world's most innovative companies deliver radically better products to their customers. By offering the best and broadest portfolio of engineering simulation software, we help them solve the most complex design challenges and create products limited only by imagination. Founded in 1970, ANSYS is headquartered south of Pittsburgh, Pennsylvania, U.S.A., Visit www.ansys.com for more information.

ANSYS and any and all ANSYS, Inc. brand, product, service and feature names, logos and slogans are registered trademarks or trademarks of ANSYS, Inc. or its subsidiaries in the United States or other countries. All other brand, product, service and feature names or trademarks are the property of their respective owners.

Ansys Blog

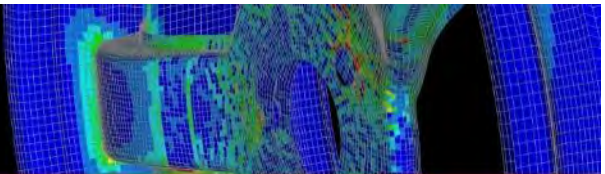

Published on September 14, 2020

by Robert Harwood

Energy, Aerospace and Defense

Clean Energy, Electric Vehicles, Aerospace

Ready for Take Off: Simulation Charges Electric Air Racing

Air Race E is the first all-electric airplane race series. With the launch of the series scheduled for the second half of 2021, the competing teams are striving to engineer the aircraft that will take part in this revolutionary form of air racing — with eight fully electric planes completing eight laps of a 5 km (3.1 mile) circuit, wing tip to wing tip, at speeds of up to 450 kph (280 mph).



Two electric planes racing Tune into the webinar to hear Air Race E CEO Jeff Zaltman introduce the electric plane race series and the associated engineering challenges.

In addition to being an amazing spectacle, the race series will serve as a testbed for new technologies that will shape the future of more sustainable aviation. Electric systems are augmenting fossil fuel-based propulsion systems and may even replace them. Airbus is a founding partner of Air Race E, which reinforces commercialization and industry adoption, much the same way as the automotive industry's Formula E develops electric vehicle technologies that are adopted in everyday automobiles.

Engineering Electric Planes

With just over a year to go, the serious business of engineering these groundbreaking aircraft is underway.

The series has been designed to focus the teams on developing solutions to some of the most pressing electrification challenges, such as energy storage and batteries, power electronics, electric drives, charging and lightweighting. The teams face stiff design criteria: 150 kW power (with +175 kW boost), 800 V maximum, delivering full power for 5 minutes with a 10-minute reserve at 30% power. And all this must be delivered by a powertrain with a mass of no more than 155 kg (341.71 lb).



Recognizing that simulation is the only practical way to get these aircraft to the start line in time for the first race, Air Race E has partnered with Ansys to enable the competing teams to access the portfolio of simulation tools they need — from systems and embedded software to electromagnetics, fluids and mechanical.

"Lacking historical design precedent for these highly sophisticated electric aircraft, simulation remains the only way to safely develop innovative technologies under incredibly tight deadlines," said Jeff Zaltman, founder and CEO, Air Race Events. "Partnering with Ansys, Air Race E teams will leverage leading-edge simulation technology to design new aircraft, achieve world-class performance levels and cross the finish line at incredible speeds. These advances will help usher in the next chapter of electric aviation."

Solve Electric Plane Engineering Challenges with Simulation

So just how are the teams planning to solve these challenges with simulation? To go under the hood and explain some of the details, Ansys and Air Race E have teamed up with IQPC and their More Electric Aircraft series to present a free-to-attend, live webinar on September 22 at 8 a.m. Eastern US/2 p.m. Central European time.

[Reserve your spot by registering to attend here.](#)



Tune into the webinar to hear Air Race E CEO Jeff Zaltman introduce the race series and the associated engineering challenges. Ansys engineers will describe how simulation is being deployed across the teams to deliver practical solutions to these challenges. The speakers will use examples derived from the race teams' active projects.

And if you can't wait until then, get a sneak peak of Ansys electrification solutions by downloading our new electrification e-book, "[Engineering What's Ahead: Electric Mobility.](#)"

[Read from website](#)

Developing CAE software systems for all simulation disciplines. Products: ANSA pre-processor/ EPILYSIS solver and META post-processor suite, and SPDRM, the simulation-process-data-and-resources manager, for a range of industries, incl. the automotive, railway vehicles, aerospace, motorsports, chemical processes engineering, energy, electronics...

BETA CAE Systems announces the new version v21.0.0 of its software suite and the release of v20.0.5 and v20.1.3

August 5, 2020

Read from our web site about v21.0.0, v20.1.3 and v20.0.5



Consistently trying to streamline emerging trends and needs in engineering simulation industry, BETA CAE Systems proudly presents the release of v21.0.0 of its software suite.

Through an attempt to couple the past with your most recent expectations, v21.0.0 offers significant advancements in plenty of fields, providing exemplary user experience and a dynamic insight.

Don't miss:

- The boosted User Performance with the new ANSA Graphics Kernel.
- The augmented pre-processing potential with the advancements in ANSA VR.
- The progressing Optimization capabilities in ANSA, as well as in SOL200 area with EPILYSIS.
- The extended Report & Automation implementations for post-processing applications.
- The promising Machine Learning integration in KOMVOS through ANSA.

[READ MORE ABOUT v21.0.0](#)

[VIDEOS](#)

[HIGHLIGHTS](#)

[DOWNLOAD](#)

Those who are committed in one of the previous versions of the BETA CAE Systems suite can benefit from the evolution releases of v20.0.5 and v20.1.3. These incorporate important enhancements and code corrections, meeting the expectations of the Industry.

[READ MORE ABOUT v20.0.5](#)

[READ MORE ABOUT v20.1.3](#)

BETA CAE Systems International AG
Platz 4, 6039 Root D4, Switzerland
t: +41-41-545-3650 | e: ansa@beta-cae.com | www.beta-cae.com

d3VIEW is a data to decision platform that provides out-of-the-box data extraction, transformation and interactive visualizations. Using d3VIEW, you can visualize, mine and analyze the data quickly to enable faster and better decisions.

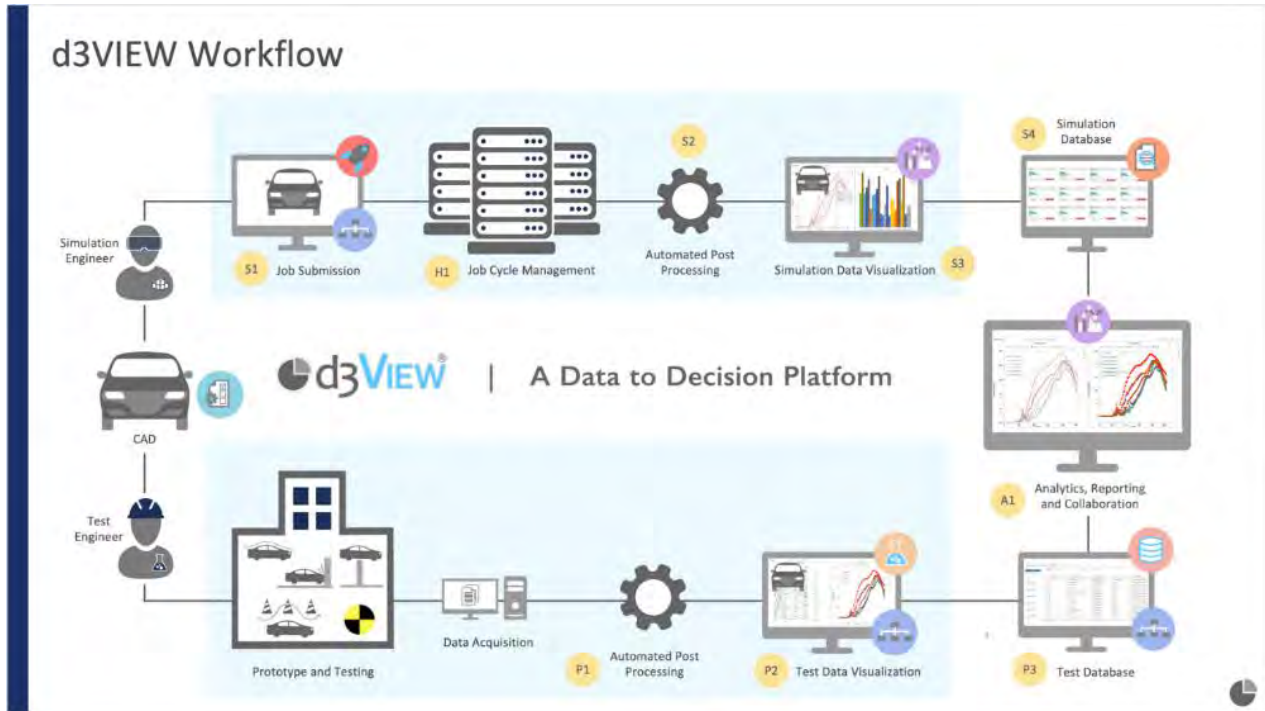

A Rich, Interactive Visualization Platform to Explore and Support Decisions

Interpret data into data visualizations (i.e. bar charts, scatter plots, heat maps, area charts, etc.)



Enhance the experience of exploring data with capabilities such as machine learning and A.I.

Utilize features such as filters and highlighters.



Analyze, compare, report and share data more efficiently.

SIMLYTIKS[®]

The Heart of Making Better Decisions

For more information, please visit d3view.com

© copyright d3VIEW Inc 2020-2021
info@d3view.com



www.d3view.com | support@d3view.com



Our online training offers

More information: www.dynamore.de/en/seminars

DYNAmore Express webinar series

The free webinars of the „DYNAmore Express“ series, which last about one hour, are held by experienced DYNAmore engineers and external tutors to inform about current topics and trends in LS-DYNA. You can find the dates on our website at www.dynamore.de/en/ex2020-e, where you can also register for the respective webinar. The webinars already held are available on our YouTube channel at <https://bit.ly/3bqPb2A>.

Duration: approx. 1 hour

Dates: regularly

Fee: none

Registration: www.dynamore.de/en/ex2020-e

Youtube: <https://bit.ly/3bqPb2A>

(Playlist DYNAmore Express)

Webinar Series „LS-DYNA Compact“

The webinars of our series „LS-DYNA Compact“ take up the topics of our on-site seminars and offer a compact summary of the most important points. Scope and contents vary and are adapted to the respective webinar topic. Usually the single modules last about two hours. You can find a complete overview on our website at www.dynamore.de/en/compact.

Duration: approx. 2 hours per unit

Dates: regularly

Fee: 200 Euro plus VAT per unit

Registration:

www.dynamore.de/en/compact

DYNAmore Video-Seminars

Our convenient video-seminars allow you to take part at our courses on your own computer and according to your own time preferences. The trainings are video recordings of the on-site seminars and correspond exactly to these in terms of content and scope. Please register via our website at www.dynamore.de/en/seminars.

Introduction to LS-DYNA

Scope: corresponds to 3 seminar days (11 chapters and 11 exercises)

Lecturers: Dr. Maik Schenke, Dr. Steffen Mattern (DYNAmore)

Date: anytime

Fee: 1,575 Euro plus VAT

Registration: www.dynamore.de/en/c2076e

Crashworthiness Simulation with LS-DYNA

Scope: corresponds to 4 seminar days (15 chapters)

Lecturer: Paul Du Bois (Consultant)

Date: anytime

Fee: 2,400 Euro plus VAT

Registration: www.dynamore.de/en/c2011

Contact

DYNAmore GmbH
Industriestr. 2, D-70565
Stuttgart, Germany
Tel. +49 (0) 7 11 - 45
96 00 - 0
E-Mail: info@dynamore.de
www.dynamore.de





A leading innovator in Virtual Prototyping software and services. Specialist in material physics, ESI has developed a unique proficiency in helping industrial manufacturers replace physical prototypes by virtual prototypes, allowing them to virtually manufacture, assemble, test and pre-certify their future products.

Driving Change for Vehicle Emission Policies

The WLTP emissions testing standard is falling short, leaving OEMs with a logistical nightmare unless regulators include simulation in this new regime. In this post, we explain how ESI is working with industry leaders to overhaul the WLTP, reduce emissions, and futureproof the automotive industry.

Wednesday, September 9, 2020 By Dr. Sebastien Vilfayeau



In September 2017, the [Worldwide Harmonized Light Vehicles Test Procedure](#) (WLTP) came into effect for the EU and Japan. How does it work? The WLTP uses various tests to measure fuel consumption, vehicle CO₂, and pollutant emissions. Engineers run these tests at specialized facilities where wind tunnels help determine the aerodynamic load for each vehicle, for example, and climatic chambers assist in testing emission rates.

The WLTP is a vast improvement compared to the prior NEDC (New European Driving Cycle) regime, providing a more accurate basis for calculating a vehicle's fuel consumption and emissions. This is because the WLTP is based on real driving data, ensuring that any lab-based measurements better reflect the on-road performance of a vehicle.



NEDC vs. WLTP

What is the WLTP?

Compared to the NEDC, the WLTP also takes a more comprehensive approach to emissions testing, using longer cycle times, greater cycle distances and average speeds, and tripling the number of tested driving phases. However, there are still many shortcomings that the WLTP must address to meet the needs of today's automotive industry.

TEST CYCLE	CYCLE TIME
<p>NEDC: Single test cycle</p> <p>WLTP: Dynamic cycle more representative of real driving</p>	<p>NEDC: 20 minutes</p> <p>WLTP: 30 minutes</p>
CYCLE DISTANCE	DRIVING PHASES
<p>NEDC: 11.5 kilometre</p> <p>WLTP: 23.25 kilometre</p>	<p>NEDC: 4 phases: 65% urban and 35% suburban driving</p> <p>WLTP: 4 more dynamic phases: 55% urban and 45% non-urban</p>
AVERAGE SPEED	MAXIMUM SPEED
<p>NEDC: 24 kilometre per hour</p> <p>WLTP: 45.5 kilometre per hour</p>	<p>NEDC: 120 kilometre per hour</p> <p>WLTP: 131 kilometre per hour</p>
INFLUENCE OF OPTIONAL EQUIPMENT	GEAR SHIFTS
<p>NEDC: Impact on CO2 and fuel performance not considered under NEDC</p> <p>WLTP: Additional features (which can differ per car) are taken into account</p>	<p>NEDC: Vehicles have fixed gear shift ratios</p> <p>WLTP: Different gear shift points for each vehicle</p>

What's the challenge with the WLTP?

The most important contribution to emissions is the aerodynamic drag of the vehicle. Under the WLTP regulation, OEM's must physically test every vehicle type and variant under real conditions to calculate the emissions that will be reported with the vehicle.

Let's explain what this means in real terms. OEMs often produce multiple vehicle types, including sedans, SUVs, hatchbacks, and so on. For each vehicle type, you can also change the parts used where, for example, different side mirrors, rims, front and rear spoilers, etc. could be added to the final design. Experts estimate that the number of vehicle customizations will [keep rising](#) in the near future to help OEMs stand out in a crowded marketplace, further exacerbating this issue. When you add together every potential vehicle iteration, that's a lot of physical emissions tests. What's more, the WLTP also requires far more testing than the previous NEDC system did. The resulting time commitments for these tests will place considerable pressure on the limited number of available testing facilities.

From a logistical standpoint, it's difficult to imagine how OEMs can run all the extensive physical tests required by the WLTP for every vehicle iteration. As these testing facilities reach full capacity, this has a knock-on effect, leaving manufacturers with an impossible choice – should they prioritize testing of their existing vehicles to promote customization or new vehicle designs to promote innovation?

Unless a different approach is taken, the WLTP will significantly restrict the automotive industry, creating a testing bottleneck where OEMs cannot keep pace with consumer demand and struggle to innovate. It's time for a change.

How to overcome the WLTP challenge

In 2017, the [WLTP CFD sub-working group](#) was created, bringing together OEMs, CFD software vendors, like ESI, and legal authorities from the EU to discuss how to address these challenges. The group agreed that simulation is a viable alternative to physical tests to determine emissions rates, under certain circumstances. These simulations must operate within a specified error range, and with approval from the responsible authority.



The WLTP CFD sub-working group

With a certified CFD process, OEMs can replace expensive and time-consuming physical tests with CFD results to evaluate deltas in aerodynamic performance between a reference shape and the design iteration, and apply the same delta to the experimental measurement of the reference case.

To that note, ESI Group produced a streamlined and robust solution so that OEMs can predict aerodynamic performances with less than 24 hours of manpower with 256 CPUs. The solution is fully automated from CAD to PDF reporting, allowing aerodynamicists to invest their time in vehicle engineering and innovation. This reduces the need for wind tunnel testing mandated by the WLTP, freeing up valuable industry resources and reducing costs for manufacturing and innovation.

How would a CFD process be certified?

The CFD methodology can be certified for WLTP in two different ways. The first procedure enables certification based on a single baseline. Here, a baseline vehicle is tested and compared with the same baseline modified by change of parts (vehicle design iterations). To validate the accuracy of the applied CFD method, at least two different design iterations per part on the same common vehicle baseline must be tested. In this case, the CFD methodology can be certified for the baseline type of car, for the two-part variances tested.

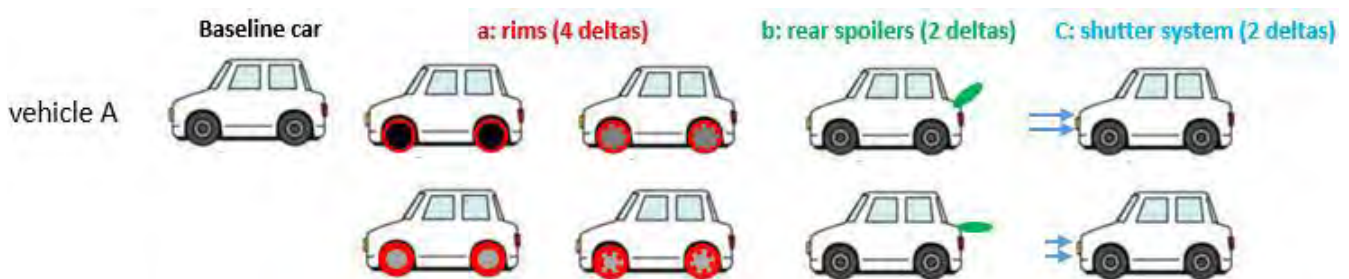

The single baseline certification procedure

The second procedure enables certification based on multiple baselines. Here, a single part is tested with a range of different vehicles. To validate the accuracy of the CFD methodology, at least eight tests must be run with the different vehicle types for the common baseline part.



The multiple baseline certification procedure

Of course, this does not negate the need for physical tests altogether. It does, however, reduce many of the pain points manufacturers face under the WLTP regime and frees up a significant proportion of the industry's overstretched testing facilities.

What's next?

The WLTP CFD sub-working group submitted its proposals to the EU on October 21, 2019. If these proposals are accepted, the discussion moves to include other countries as we push to introduce WLTP certification by CFD at the United Nations. We're facing a difficult road ahead, where the Ministry of Land, Infrastructure, Transport and Tourism in Japan has, until now, opposed these changes.

However, the automotive industry must overcome the challenges of real-world emissions testing to provide both vehicle customization and innovation. With many of the world's biggest manufacturers implementing the WLTP, now is the time to move emissions testing into the digital domain using Cloud applications.

For more information visit:

[Build and Deliver Products at the Edge of Innovation with Advanced CFD and High-Fidelity Multi-Physics Simulations](#)

[Reducing Greenhouse Gas Emissions](#)

ETA has impacted the design and development of numerous products - autos, trains, aircraft, household appliances, and consumer electronics. By enabling engineers to simulate the behavior of these products during manufacture or during their use, ETA has been involved in making these products safer, more durable, lighter weight, and less expensive to develop.



DYNAFORM

DYNAFORM is a simulation software solution, which allows organizations to bypass soft tooling, reducing overall tryout time, lowering costs, increasing productivity & providing complete confidence in die system design. It also allows for the evaluation of alternative and unconventional designs & materials.

DYNAFORM Version 6.0 is Now Available!

DYNAFORM 6.0 is the sixth-generation DYNAFORM product. It provides a user-friendly and intuitive interface with a streamlined design. The analysis process is fully based on the stamping process, which requires less CAE knowledge, and minimum geometry and element operations. This latest release offers the following features and improvements:

- Intuitive and Streamlined Interface
- Tree Structure to Manage Operation
- Simulation Data Manager
- Customized Icons Grouping for Drop-down Menu Functions
- Separate and Independent Application
- Unified Pre and Post Processing
- Multi-Window View
- Access Functions Using Right Mouse Button Clicks
- Supports Large Forming Simulation Models
- Geometry Manager
- Process Wizard for Blank Size Engineering
- Minimum Geometry and Elements Operations
- New Material Library Window
- New Drawbead Shape and Library
- Coordinate System Manager
- Instant Section Cut
- Tata Steel FLD
- Balloon Label
- PowerPoint and Excel Based Automatic Formability Report Generation

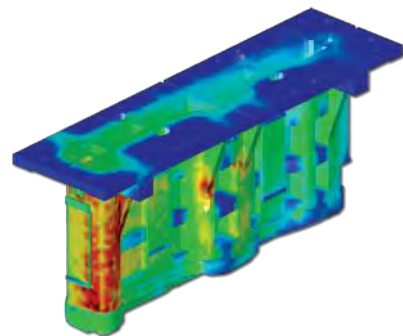
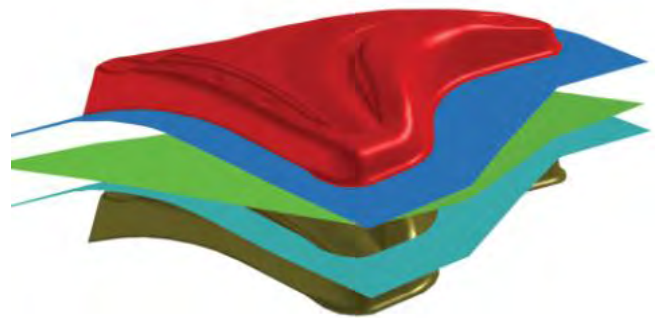

FEA Not To Miss, is a weekly internet blog on helpful videos, tutorials and other Not To Miss important internet postings. Plus, a monthly email blog.



Start your Monday with coffee or tea reading our engineering blog, at the FEA Not To Miss coffee shop. Postings every Monday on what you have missed

www.feantm.com

09/14/2020 - Yes, I know I had the below simulation showcased last year but I really like it. Gotta love a Ferrari, although on this ranch it would not be useful - WAIT, I can race the horses and win!

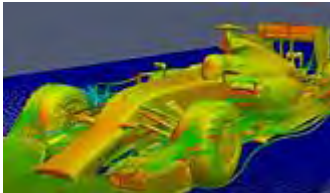

[Simulation of the F1 Ferrari](#)

Simulation and you can obtain the input deck.

09/07/2020 - See below for my new delivery type of motorcycle! NOT! I rather deliver riding a horse over that road break! NOT! My 3-speed bicycle (It's so old that it only has 3 speeds - (my blue Denault English Racer) Anyway, I will deliver in my Ford Sport Trac the Coffee A La Speed Bump!



[Simulación Motocicleta LS-DYNA](#)

Analysis of the motorcycle beater when passing through a speed break at a speed of 10 km / h.

Monday 08/31/2020 - Yes, like they stated in the simulation "everything starts with a failure" LIKE that FIRE California had last week. We didn't have to evacuate but they had us under warning. I think I drank all the coffee! Nerves - coffee - pack - coffee - panic - coffee - save the animals - coffee. Okay you get the idea of my last few days. Now it is unpack - more coffee!!!



[Marine Applications](#)

highly simplified simulations involving rigid parts and coarse mesh, ...may be developed further for specific applications.

Shanghai Hengstar & Enhu Technology sells and supports LST's suite of products and other software solutions. These provide the Chinese automotive industry a simulation environment designed and ready multidisciplinary engineering needs, and provide a CAD/CAE/CAM service platform to enhance and optimize the product design and therefore the product quality and manufacture.



Online Training of Application of tire finite element simulation

Shanghai Enhu & Hengstar Technology will organize a Web Training of Application of tire finite element simulation on Sep 28th 2020.

Contents:

The following topics will be discussed with interactive sessions to the attendees.

1. Tire model modeling and structure introduction
2. Static and dynamic mechanical properties testing of tire models
3. Tire rubber material testing and failure simulation
4. The modeling process of finite element model of tire
5. Case analysis

Instructor :

Suri Bala

Suri Bala works full-time for LSTC since 2000. He specializes in the field of numerical simulations ranging from pure Lagrangian, Arbitrary - Lagrangian-Eulerian, to mesh free techniques such as SPH and EFG. His many years of onsite support activity provided him with a wealth of experience in building and handling large vehicle models.

Duration and Style:(1×3 hours web training)

Sep 28th (20:00PM--23:00PM)

Language: English

Training fee:Free

Contact:

Xixi Fei

Tell:021-61630122 Mobile:13524954631

Email: Training@hengstar.com

Shanghai Hengstar Technology Co., Ltd

hongsheng@hengstar.com

<http://www.hengstar.com>

Shanghai Enhu Technology Co., Ltd

<http://www.enhu.com>



JSOL supports industries with the simulation technology of state-of-the-art. Supporting customers with providing a variety of solutions from software development to technical support, consulting, in CAE (Computer Aided Engineering) field. Sales, Support, Training.

General-Purpose Nonlinear Analysis Program Simulating Complex Real World Problems

General-purpose finite element program
LS-DYNA[®]

- Material models: metal, rubber, resin and composite, and more
- From a desktop PC to a supercomputer
- Cutting-edge technologies: time development, spatial discretization
- Application: crash, strength, forming analysis



LS-DYNA Features

LS-DYNA opens the nonlinear world

The phenomena adopted for developing product designs are becoming increasingly complex: automotive crashes, metal forming, forging, large deformations of rubber materials, and failure of plastic parts. CAE simulation is now an essential tool for attaining a complex and high-quality design

in various industries. LS-DYNA was originally introduced by Dr. John O. Hallquist at the Lawrence Livermore National Laboratory in the 1970s. In the late 1980s, Livermore Software Technology, LLC (LST, LLC) was founded to develop LS-DYNA as a commercial code. LST, LLC has been committed to developing LS-DYNA for solving nonlinear problems more precisely and stably. LS-DYNA is now known worldwide as one of the best nonlinear solvers and is used in both the academic and the industrial worlds.



KAIZENAT Technologies Pvt Ltd is the leading solution provider for complex engineering applications and is founded on Feb 2012 by Dr. Ramesh Venkatesan, who carries 19 years of LS-DYNA expertise. KAIZENAT sells, supports, trains LS-DYNA customers in India. We currently have office in Bangalore, Chennai, Pune and Coimbatore.



Kaizen-DYNA App

- "Kaizen-DYNA" is a mobile and web based application which is built by Kaizenat Technologies Private Limited (KTPL) to help LS-DYNA users across the world.
- This powerful application helps LS-DYNA users across the world to stay connected and also help each other by sharing their knowledge.
- The key feature of this application is QUERY and RESPONSE. Where a user can post and respond to queries. The best response for each query will be rewarded with a Kaizen score.
- This application also gives an opportunity for the employers to float their LS-DYNA job openings and alert its user's base with a notification.
- "Kaizen-DYNA" quiz program can help LS-DYNA users to update their knowledge score and trend top in the job seekers list.
- It also gives an opportunity for new users to learn LS-DYNA with training materials FAQ modules.
- This application also brings latest news about LS-DYNA and some useful general information.



Android App



iPhone App



Web App

Contact

Email : support@kaizenat.com

Phone: +91 80 41500008

A team of engineers, mathematicians, & computer scientists develop LS-DYNA, LS-PrePost, LS-OPT, LS-TaSC, and Dummy & Barrier models, Tire models.

LS-TaSC™ for Topology and Shape Design

LS-TaSC is for the topology and shape optimization of large non-linear problems, involving dynamic loads and contact conditions. The focus is on multidisciplinary topology optimization considering a combination of impact, statics, and NVH load cases. The methodology is specifically developed for huge models and requires no special treatment for nonlinearities such as contact.

General abilities

- Solid design using 1st-order hexahedrons, pentahedra, and tetrahedral elements
- Shell design using 1st-order quadrilateral and triangular elements
- Global constraints using the multi-point scheme and surrogate models
- Multiple load cases such as impact, statics, and NVH load cases with/out element deletion
- Occupant safety features such as global variables and responses
- Models with more than 10 million elements
- Geometry definitions such as multiple parts, extrusion, symmetry, edge smoothing, one or two sided casting

Methodologies

- Solid / Void Schemes: SIMP, True Mechanics
- Analytical and/or Numerical Design Sensitivity Analysis
- Optimality Criteria for Dynamic Problems
- Projected Sub-gradient Design Optimization Method
- Design Contribution Estimation

Integration

- With LS-DYNA – No special treatment for nonlinearities such as contact
- With LS-PrePost – Results visualization and model editing
- With LS-OPT – LS-OPT can drive LS-TaSC for complex design schemes

LS-TaSC User Interface

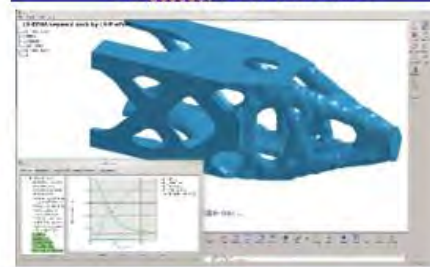

Surface Design

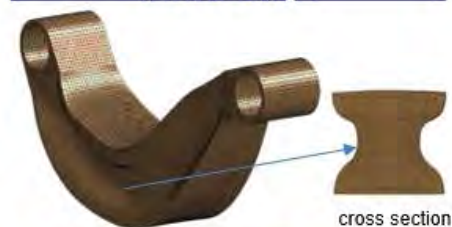

Hood Design



Crash Box Design



Final design of crash box



Deformation at t=30 ms

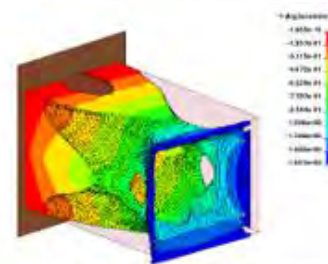

First bending mode in y-direction

LS-TaSC[®] New Release Version 4.2

LS-TaSC Version 4.2 has the following new features:

1. *Constrained Multidisciplinary Design Optimization*: this release can solve multidisciplinary topology optimization problems for the combination of impact, NVH, and static load cases. The importance of each design discipline is defined using one or more constraints. The design sensitivity analysis of constraints related to NVH is computed analytically, while the design sensitivity of the impact related constraints is handled using a numerical, multipoint scheme. This design framework can therefore tackle complex problems; for example, the hood structure below was solved for a HIC (Head Injury Criterion) constraint from an impact load together with a displacement constraint from a static load, while the problem at the bottom of the page considered both the natural frequency and the crash deformation behavior.



Hood optimization problem considering both impact and static load cases. Model courtesy of Jaguar Land Rover.



Final design of Hood with side view at upper and bottom view at lower

2. The constraints from different load cases can have drastically different scales. *Normalizing constraints using bounds* was therefore added as an optional setting in the Method dialog.
3. Contact setting was updated to (1) *set eroding surface contact automatically*, and (2) *allow mortar contact definitions*.
4. Failed elements are handled by strengthening them, instead of deleting them as before.
5. The design contribution plots show the effect of the different design disciplines on the final design. These plots were updated to account for the effects of the constraints.

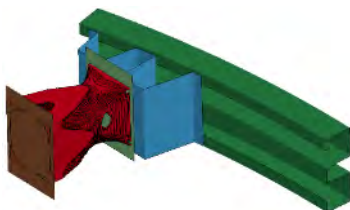

Final design of crash box for crashworthiness and NVH

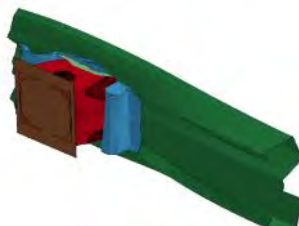

Crashing deformation at t=30 ms

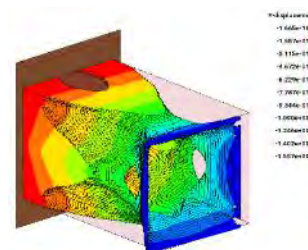

First bending mode in y-direction

New version download: <http://ftp.lstc.com/user/ls-tasc/v4.2/>

Providing engineering services to the composites industry since 1970. During this time, we have participated in numerous programs that demonstrate our ability to perform advanced composite design, analysis and testing; provide overall program management; work in a team environment; and transition new product development to the military and commercial sectors.



Progressive Composite Damage Modeling in LS-DYNA (MAT162 & Others)

Bazle Z. (Gama) Haque, Ph.D.

Senior Scientist, University of Delaware Center for Composite Materials (UD-CCM)
 Assistant Professor of Mechanical Engineering, University of Delaware, Newark, DE 19716
 P: (302) 690-4741 | E: bzhaque@udel.edu

Final 2020 Webinar Course Date
 November 17, 2020

Cost: \$695 per person
Includes: USB with Course Content

Description:

Progressive damage modeling of composites under low velocity impact, and high velocity impact is of interest to many applications including car crash, impact on pressure vessels, perforation and penetration of thin and thick section composites. This course will provide a comparison between available composite models in LS-DYNA for shell and solid elements, e.g., MAT2, MAT54, MAT59, & MAT162. Among these material models, rate dependent progressive composite damage model MAT162 is considered as the state of the art. This short course will include the theory and practice of MAT162 composite damage model with applications to low and intermediate impact velocities, understanding the LS-DYNA programming parameters related to impact-contact, damage evolution, perforation and penetration of thin- and thick-section composites. Printed copies of all lecture notes will be provided along with a CD containing all example LS-DYNA keyword input decks used in this short course. Topics Covered in this Short Course:

Impact and Damage Modeling of Composites

Application of MAT162 in Engineering and Research Problems

Introduction to Composite Mechanics

Introduction to Continuum Mechanics and Composite Mechanics

Composite Material Models in LS-DYNA for Shell and Solid Elements

Discussion on MAT2, MAT54, MAT59, & MAT162

Theory and Practice in MAT162 Progressive Composite Damage Model for Unidirectional and Woven Fabric Composites

MAT162 User Manual – Version 15A 2015

Progressive Damage Modeling of Plain-Weave Composites using LS-Dyna Composite Damage Model MAT162

Unit Single Element Analysis

Comparison between Different LS-DYNA Composite Models

Sphere Impact on Composite SHELL & SOLID Plates

Low Velocity Impact and Compression after Impact Applications

Modeling the Low Velocity Impact and Compression after Impact Experiments on Composites Using MAT162 in LS-DYNA

Perforation Mechanics of 2-D Membrane and Thin Composites

Penetration Mechanics of Composites and Soft-Laminates

Introduction to LS-DYNA (Document Only)

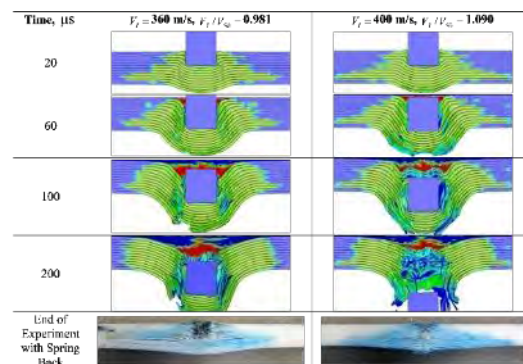

To register, please [click here](#).

Oasys Ltd is the software house of Arup and distributor of the LS-DYNA software in the UK, India and China. We develop the Oasys Suite of pre- and post-processing software for use with LS-DYNA.

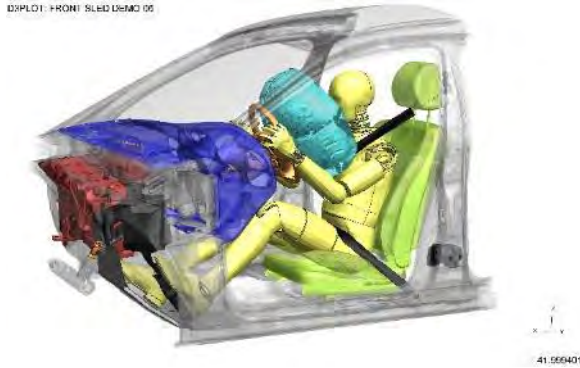

Webinar to watch again Session 2 Deciphering LS-DYNA Contact Algorithms

This is the second webinar in a series sessions which provide a walk through of the contact algorithms in LS-DYNA by providing many theoretical and practical insights about their usage.

[View here](#)



Upcoming webinar
16th September 2020
12:30 - 01:30 BST

Oasys PRIMER and D3PLOT: composite tools

Oasys PRIMER is used worldwide to pre-process LS-DYNA models. As well as the core tools for model creation and checking, Oasys PRIMER contains many tools to make it easier to setup automotive models/loadcases.

This webinar will introduce these tools and demonstrate how to use them.

[Register here](#)



Top Tip video: Multiple Models

Did you know Oasys D3PLOT allows you to open multiple models which you can interact with separately or synchronously? To watch this video please click [here](#).

If you would like to view the full playlist of Top Tip videos please click [here](#).

[Click here to view it](#)



Oasys LS-DYNA LinkedIn Group

We would like to invite you to join our Oasys LS-DYNA Environment Software LinkedIn Group. It's a channel to share content with other Oasys LS-DYNA software users, from interesting simulations to information about our webinars and training courses.

Please feel free to join us.

<https://www.linkedin.com/groups/4429580/>

Predictive Engineering provides FEA and CFD consulting services, software, training and support to a broad range of companies



Predictive Engineering – Western States ANSYS LS-DYNA Distributor – Your Free Coffee Cup is On Its Way!

LS-DYNA has been one of Predictive’s core analysis tools pretty much since we got started in 1995. It is an amazing numerical workhorse from the basic linear mechanics (think ANSYS or Nastran) to simulating well nigh the impossible. At least that is the way I feel at times when the model is not solving and spitting out arcane error messages and I’m basically questioning my sanity for accepting this project from hell that has a deadline at the end of the week. Which brings me to my favorite project management image – “trough of despair followed by wiggles of false hope then crash of ineptitude and finally the promised land” but I’ll leave that for another blog.

For now, let’s talk about those free coffee cups. Predictive is now the western states distributor of ANSYS LS-DYNA and provides complete sales, training and services for ANSYS LS-DYNA clients in this region. It is a continuation of our prior setup with LSTC (now ANSYS LST) with the addition of Predictive’s ability to offer ANSYS Workbench with LS-DYNA and other ANSYS software tools. So where’s my free coffee cup? If you are a current Predictive ANSYS LS-DYNA client, we’ll be shipping’em out to you at the end of February and for our new client’s – just send us an email or give us a call.

View our portfolio
[FEA, CFD and LS-DYNA consulting projects](#)

Composite Engineering

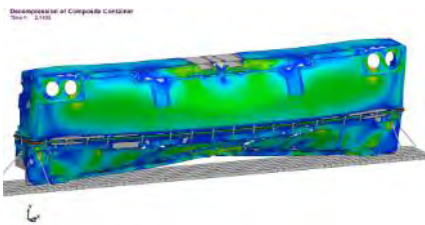

Nonlinear Dynamics

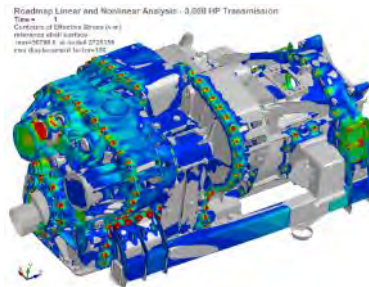

Aerospace

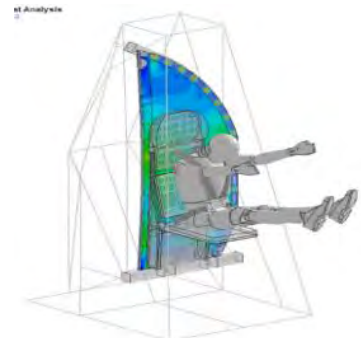

Contact:

Address:
2512 SE 25th Ave
Suite 205
Portland, Oregon 97202
USA

Phone:
503-206-5571
Fax: 866-215-1220
E-mail:
sales@predictiveengineering.com

NASA 5020A - Its All in the Bolt Preload

September 7, 2020 Posted By: George Laird

NASA 5020A Requirements for Threaded Fastening Systems in Spaceflight Hardware

Over the years, we have done a number of satellite analysis projects for commercial and those other government agencies. Looking back, I'm sort of surprised how close we got with what we thought were FEA best practices for linear dynamics (i.e., normal modes and PSD analysis). The big advance over the last couple of years has been in our approach to fastener modeling. In prior work, fasteners (bolts, screws, what-ever) were idealized using beams and rigid links (Nastran RBE2) while nowadays, our preference is to use six DOF springs (Nastran C-Bush) in combination with rigid links. While a bit messy, it provides an efficient methodology to meet the NASA 5020A technical specification.

The gist of this specification is how to calculate, whether or not, the fastener will fail given: bolt preload, with and without shear pins and joint slippage. It is a tall order and the specification is a algebraic joy to the mathematically inclined simulation engineer. Fastener failure is dominated by the designer's choice of bolt preload. Interesting enough, the NASA specification favors low bolt preload. It sounds odd, but if pushed, one can avoid NASA 5020A fastener failure by lowering the bolt preload. The reason for this is due to the relationship between bolt preload and the applied tensile load. There is no free lunch and regardless of the initial bolt preload, the applied load adds to the overall bolt tensile load. The specification favors hand calculation but with some FEA modeling, one can improved upon the hand calculations and eke out a bit more headroom. If you would like to read more, the NASA 5020A specification can be downloaded here.

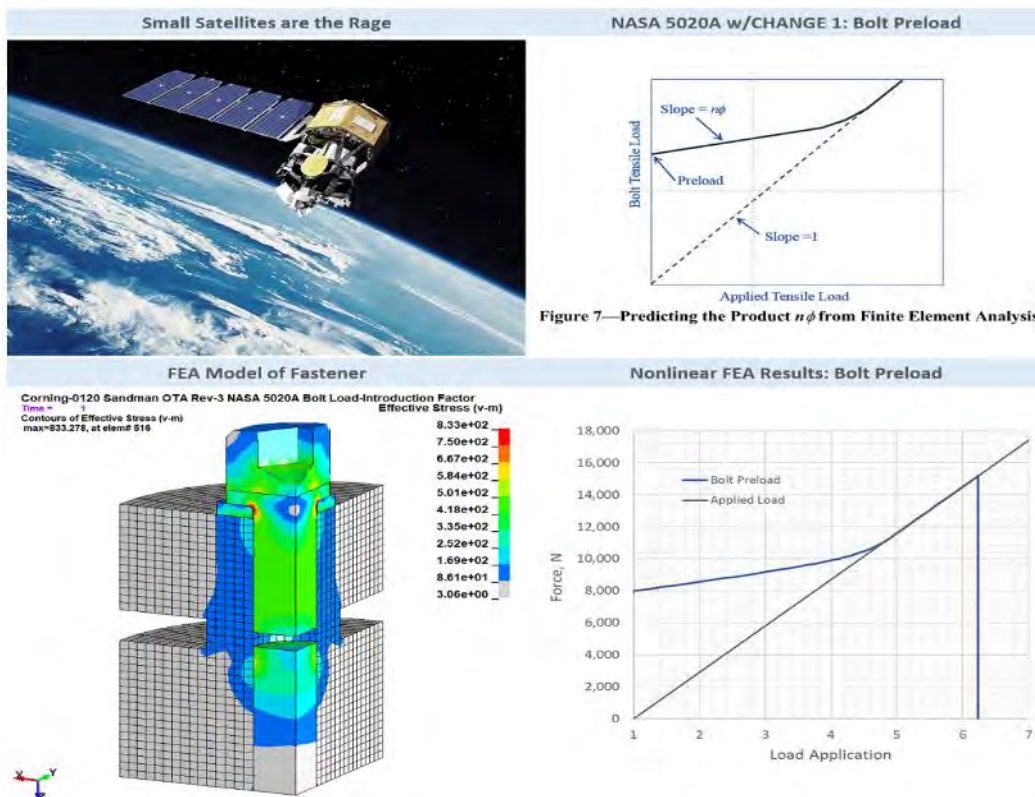
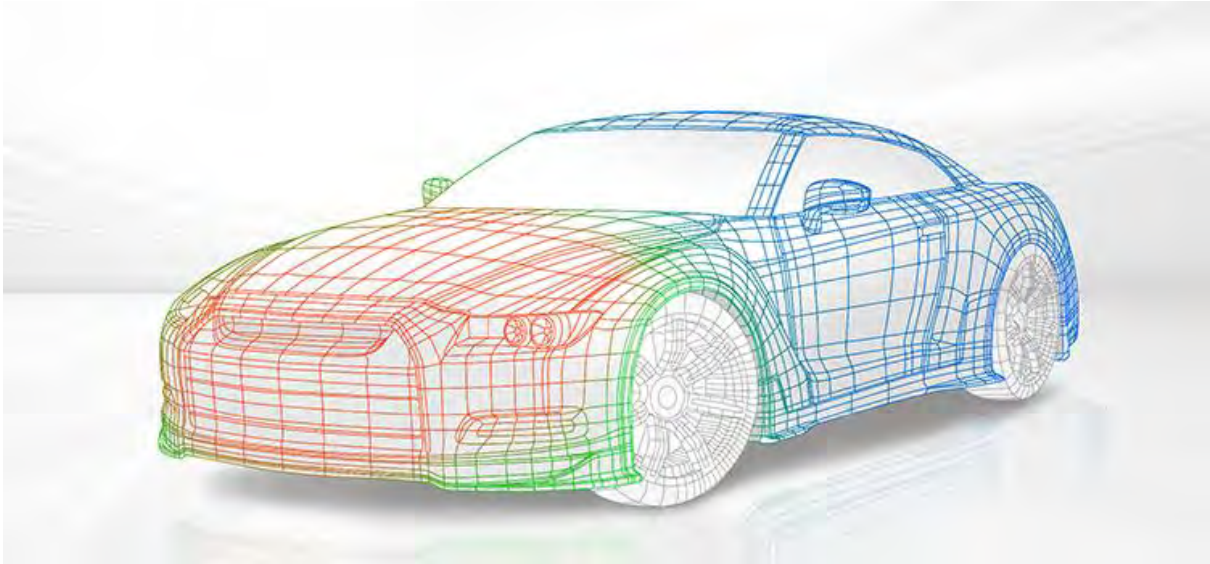

Figure 7—Predicting the Product $n\phi$ from Finite Element Analysis

Offering industry-leading software platforms and hardware infrastructure for companies to perform scientific and engineering simulations. Providing simulation platforms that empower engineers, scientists, developers, and CIO and IT professionals to design innovative products, develop robust applications, and transform IT into unified, agile environments.



Platform Updates and Software Release Notes – September 2020

September 15, 2020
Automotive, English, Product Info & Tutorials
Jolie Hales

Rescale now works with more than 600 applications.

Here are a few **recent highlights**:

FreeFEM 4.6 – FreeFEM is a popular 2 and 3D partial differential equations (PDE) solver used by thousands of researchers across the world. It allows you to easily implement your own physics modules using the provided FreeFEM language. Learn more [here](#).

MedeA 3.1 – MedeA is the leading environment for materials design, modeling, and simulation for the Windows and Linux software platforms, designed and engineered to provide access to high quality simulation methods. Learn more [here](#).

USGS COAWST – Coupled Ocean-Atmosphere-Wave-Sediment Transport, or COAWST, is a modeling system created by the U.S. Geological Survey to understand processes responsible for coastal change. Learn more [here](#).

ESI Visual-Environment 16.0 – Visual-Environment is a single integrated user environment that caters to the engineering simulation needs across major industries. It includes a comprehensive modeling tool to generate quality meshes on complex geometries for various engineering domains. Learn more [here](#).

ESI ProCAST 2020.0 – ESI ProCAST is an integrated software suite for the foundry industry that improves casting yield and quality. Learn more [here](#).

OrcaFlex – OrcaFlex is a leading package for the dynamic analysis of offshore marine systems, renowned for its breadth of technical capability and user friendliness. OrcaFlex also has the unique capability in its class to be used as a library, allowing a host of automation possibilities and ready integration into 3rd party software. Learn more [here](#).

Our full software catalog is available [here](#).

Interested in learning more or about application availability?

[CONTACT AN EXPERT](#)

LS-DYNA China, as the master distributor in China authorized by LST, an Ansys company, is fully responsible for the sales, marketing, technical support and engineering consulting services of LS-DYNA in China.



Ansysis Innovation Conference 2020

Ansysis Innovation Conference in China will be held online by Ansys China on 17th -18th, September. There will be several sessions including LS-DYNA, Autonomous, Electrification, 5G, Digital transformation topics, etc on this conference. As the most influential annual event of the CAE industry in China, it is expected that thousands customers from various industries will attend this conference.

For LS-DYNA session, several LS-DYNA developers from LSTC and experts from various industries will give reports to share their knowledge and experience on LS-DYNA. As one of the sponsors, Shanghai Fangkun will also give several reports on LS-DYNA topics at the conference. Welcome to join us to share and communicate with experts from all industries.



Please register to join us through QR code as above or you could mail us at marketing@lsdyna-china.com. For more information please follow our official Wechat Account LSDYNA or website www.lsdyna-china.com.

Contacts:
Tel.: 021-61261195 54152972
Email: marketing@lsdyna-china.com

Website www.lsdyna-china.com.



2020 Annual Training & Workshop

Dear LS-DYNA users,

To help users to better understand LS-DYNA software and use LS-DYNA more efficiently, Shanghai Fangkun releases 2020 annual training and workshop plan as following tables. We welcome those who are interested to attend.

Date	Topic	City	Duration
20-21, Feb.	Introduction to LS-DYNA (basic training)	Shanghai	2 days
Mar.	Product design with LS-OPT	Shanghai	1 day
Apr.	Crashworthiness in LS-DYNA	Shanghai	2 days
May	Material models in LS-DYNA (composite, non-metal)	Shanghai	2 days
Jun.	Introduction to LS-DYNA (basic training)	Chongqing	2 days
Jun.	Restraint system in LS-DYNA	Shanghai	2 days
Jul.	Battery multi-physics simulation with LS-DYNA	Shanghai	1 day
Sep.	Implicit analysis in LS-DYNA	Shanghai	1 day
Oct.	Fluid structure interaction with LS-DYNA (ALE, ICFD)	Shanghai	2 days
Nov.	Introduction to LS-DYNA (basic training)	Beijing	2 days
Dec.	User-Defined Materials in LS-DYNA	Shanghai	1 day

2020 LS-DYNA online workshop plan			
Date	Topic	Duration	Fee
13rd Jan.	Introduction to MPDB	3 hours	Free
Apr.	Contact Modeling in LS-DYNA	2 hours	Free
May	SALE method in LS-DYNA	2 hours	Free
Jun.	Introduction to Q series dummies	2 hours	Free
Jul.	NVH, Fatigue, & Frequency Domain Analysis in LS-DYNA	2 hours	Free
Aug.	SPG method in LS-DYNA	2 hours	Free
Sep.	Introduction to LS-PrePost	2 hours	Free
Sep.	Introduction to LS-OPT	2 hours	Free
Oct.	Introduction to LS-Form & Stamp forming	2 hours	Free
Oct.	Performance analysis of bus with LS-DYNA	2 hours	Free
Nov.	LST Dummy & Barrier	2 hours	Free
Nov.	EM method in LS-DYNA	2 hours	Free
Dec.	Summary of fluid structure interaction method in LS-DYNA	2 hours	Free
Dec.	Virtual Proving Ground training	2 hours	Free

Contact: Elva Yu Tel.: 18221209107, 021-61261195 for more detail information

Email: Training@lsdyna-china.com

CAE software sale & customer support, initial launch-up support, periodic on-site support. Engineering Services. Timely solutions, rapid problem set up, expert analysis, material property test Tension test, compression test, high-speed tension test and viscoelasticity test for plastic, rubber or foam materials. We verify the material property by LS-DYNA calculations before delivery.



CAE consulting - Software selection, CAE software sale & customer support, initial launch-up support, periodic on-site support.

Engineering Services - Timely solutions, rapid problem set up, expert analysis - all with our Engineering Services. Terrabyte can provide you with a complete solution to your problem; can provide

you all the tools for you to obtain the solution, or offer any intermediate level of support and software.

FE analysis

- LS-DYNA is a general-purpose FE program capable of simulating complex real world problems. It is used by the automobile, aerospace, construction, military, manufacturing and bioengineering industries.
- ACS SASSI is a state-of-the-art highly specialized finite element computer code for performing 3D nonlinear soil-structure interaction analyses for shallow, embedded, deeply embedded and buried structures under coherent and incoherent earthquake ground motions.

CFD analysis

- AMI CFD software calculates aerodynamics, hydrodynamics, propulsion and aero elasticity which covers from concept design stage of aircraft to detailed design, test flight and accident analysis.

EM analysis

- JMAG is a comprehensive software suite for electromechanical equipment design and development. Powerful simulation and analysis

technologies provide a new standard in performance and quality for product design.

Metal sheet

- JSTAMP is an integrated forming simulation system for virtual tool shop based on IT environment. JSTAMP is widely used in many companies, mainly automobile companies and suppliers, electronics, and steel/iron companies in Japan.

Pre/ Post

- **PreSys** is an engineering simulation solution for FE model development. It offers an intuitive user interface with many streamlined functions, allowing fewer operation steps with a minimum amount of data entry.
- **JVISION** - Multipurpose pre/post-processor for FE solver. It has tight interface with LS-DYNA. Users can obtain both load reduction for analysis work and model quality improvements.

Biomechanics

- **The AnyBody Modeling System™** is a software system for simulating the mechanics of the live human body working in concert with its environment.

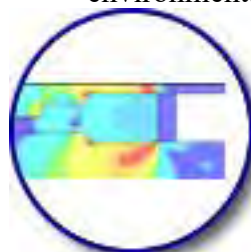



General Motors' Future Electric Vehicles to Debut Industry's First Wireless Battery Management System

Technology developed in collaboration with Analog Devices, Inc.

2020-09-09

DETROIT — General Motors will be the first automaker to use an almost completely wireless battery management system, or wBMS, for production electric vehicles. This wireless system, developed with Analog Devices, Inc., will be a primary driver of GM's ability to ultimately power many different types of electric vehicles from a common set of battery components.

The wBMS is expected to drive GM's Ultium-powered EVs to market faster, as time won't be needed to develop specific communications systems or redesign complex wiring schemes for each new vehicle. Instead, the wBMS helps to ensure the scalability of Ultium batteries across GM's future lineup, encompassing different brands and vehicle segments, from heavy-duty trucks to performance vehicles.

Much like the [pack design](#) of GM's Ultium batteries, which is flexible enough to incorporate new chemistry over time as technology changes, the wBMS' basic structure can easily receive new features as software becomes available. With expanded over-the-air updates provided by GM's all-new Vehicle Intelligence Platform, the system could even be upgraded over time with new software-based features via smartphone-like updates.

"Scalability and complexity reduction are a theme with our Ultium batteries – the wireless battery management system is the critical enabler of this amazing flexibility," said Kent Helfrich, GM executive director of Global Electrification and Battery Systems. "The wireless system represents the epitome of Ultium's configurability and should help GM build profitable EVs at scale."

The wBMS will help GM's electric vehicles balance chemistry within the individual battery cell groups for optimal performance. It can also conduct real-time battery pack health checks and refocus the network of modules and sensors as needed – this helps safeguard battery health over the vehicle's lifespan.

By reducing wires within the batteries by up to 90 percent, the wireless system can help extend charging range by creating lighter vehicles overall and opening extra room for more batteries. The space and flexibility created by this reduction in wires not only enables a cleaner design, but also simpler and more streamlined battery restructuring as needed and more robust manufacturing processes.

This wireless system also provides a unique repurposing capability for battery reuse in secondary applications more easily than conventional wired monitoring systems. When the wireless packs are capacity-reduced to the point where they are no longer ideal for optimum vehicle performance, but still functional as consistent power supplies, they can be combined with other wireless battery packs to form clean power generators. This can be done without a redesign or overhaul of the battery management system traditionally required in second-life usage.

GM's wireless battery management system is protected by cybersecurity measures that are foundational to the company's all-new electrical architecture or Vehicle Intelligence Platform. The DNA of this system includes protective features within the hardware and software layers, including protection of wireless communications.

"General Motors is paving the way toward an all-electric future, and Analog Devices is proud to work with this highly respected automotive leader on the next generation of electric vehicles," said Greg Henderson, Analog Devices, Inc. senior vice president of Automotive, Communications, and Aerospace & Defense. "Our collaboration is aimed at accelerating the transition to electric vehicles and a sustainable future."

The wireless battery monitoring system will be standard on all planned GM vehicles powered by Ultium batteries.

General Motors (NYSE:GM) is a global company committed to delivering safer, better and more sustainable ways for people to get around. General Motors, its subsidiaries and its joint venture entities sell vehicles under the Chevrolet, Buick, GMC, Cadillac, Holden, Baojun and Wuling brands. More information on the company and its subsidiaries, including OnStar, a global leader in vehicle safety and security services, can be found at <http://www.gm.com>.

Analog Devices, Inc. (Nasdaq: ADI) is a leading global high-performance analog technology company dedicated to solving the toughest engineering challenges. We enable our customers to interpret the world around us by intelligently bridging the physical and digital with unmatched technologies that sense, measure, power, connect and interpret. Visit <http://www.analog.com>

LS-DYNA - Resource Links

LS-DYNA Multiphysics YouTube

<https://www.youtube.com/user/980LsDyna>

FAQ LSTC

<ftp.lstc.com/outgoing/support/FAQ>

LS-DYNA Support Site

www.dynasupport.com

LS-OPT & LS-TaSC

www.lsoptsupport.com

LS-DYNA EXAMPLES

www.dynaexamples.com

LS-DYNA CONFERENCE PUBLICATIONS

www.dynalook.com

ATD –DUMMY MODELS

www.dummymodels.com

LSTC ATD MODELS

www.lstc.com/models www.lstc.com/products/models/maillinglist

AEROSPACE WORKING GROUP

<http://awg.lstc.com>

Training - Webinars



Participant's Training Classes

Webinars

Info Days

Class Directory

Directory

BETA CAE Systems	www.beta-cae.com/training.htm
DYNAmore	www.dynamore.de/en/training/seminars
Dynardo	http://www.dynardo.de/en/wost.html
ESI-Group	https://myesi.esi-group.com/trainings/schedules
ETA	http://www.eta.com/training
KOSTECH	www.kostech.co.kr
ANSYS LST	www.lstc.com/training
LS-DYNA OnLine - (Al Tabiei)	www.LSDYNA-ONLINE.COM
OASYS	www.oasys-software.com/training-courses
Predictive Engineering	www.predictiveengineering.com/support-and-training/ls-dyna-training

Constrained Multidisciplinary Topology Optimization

Willem Roux, Imtiaz Gandikota, Guilian Yi

*Livermore Software Technology, an ANSYS Company
7374 Las Positas RD, Livermore, CA 94551, USA*

Abstract

For multidisciplinary topology optimization it can be difficult to select the weights for each load case. This becomes even harder if there are multiple design considerations per case. But if constraint values can be defined, then the problem is solvable, because the problem is transformed into one of satisfying the constraints. The most difficult constraint to control is that of the crash pulse, because the existing linear methodologies cannot be used – solutions such as multipoint strategies and spatial kernels must be introduced instead. The NVH constraints are however linear, and solving the NVH constraints in combination with the crash pulse becomes a two-level problem. In this paper we show multidisciplinary design optimization considering constraints from impact, linear statics, and frequency load cases.

Introduction

For vehicle design one has a multitude of design considerations, of which some are likely in conflict. For example, the standard topology objective of minimum compliance may increase the lethality of the impact forces. There is therefore a need for multidisciplinary topology optimization methodologies.

Topology optimization [1,2,3] finds the layout of a structure supporting the required load by starting with a ground structure within which the required structural topology or load path must be found. Much of the current research in topology optimization is driven by additive manufacturing [2,3].

Multi-objective topology optimization is important in many cases, with modern direction of investigation varying from vehicle design as in this study to the design of pelvic prostheses [4]. A current approach of doing multidisciplinary topology optimization is presented by choosing weights for each load case and doing a trade-off study. This is workable if only there is only a single design consideration per load case. Specifically, it won't work when designing for a NVH (Noise, Vibration and Harshness) load case considering both the fundamental frequency and the first bending/torsion mode frequency, together with an impact load case considering both an energy requirement and a limit on the peak acceleration, because two load case weights cannot be used to control four constraints.

Designing for vehicle occupant protection typically consider a force-displacement curve in some form. For example, the energy E and the load resistance R of a part are related as $E = \int R(u)dx$ with u the displacement. The main technological problem is that of design for the crash pulse and the energy absorbed as described for example in [5]. Design sensitivity information (the derivatives of the constraints and objective with respect to the design variables) is normally used to solve design optimization problems; for example Weider and Schumacher [6] computed topological derivatives considering both material and geometrical nonlinearities. A design sensitivity implementation is however not feasible for impact problems and an alternative method such as surrogate modeling which does not require analytical gradients is required.

sensitivity information. This is solved by using a spatial kernel approach [7] allowing the use of a multipoint scheme. The multipoint and the related metamodeling schemes were first developed by the Livermore Software Technology team in work that started before 2015 [8,9,10,11]. Through our clients such as Honda Research Institute it became known to others. The method has been shown to be able to control the crash pulse and maximize energy absorption [5].

Constrained multi-disciplinary topology optimization

Solving general problems using a dual problem or a saddle point

Considering the load resistance of a part -- the energy E is $E = \int R(u)dx$ with R the resistance and u the displacement. Designing for maximum energy absorption in occupant protection is often stated as $max_x E(x)$ with x the topology variables. This will however not yield the desired result, because a structure must be at its minimum energy state to be stable -- simply maximizing the energy can result in infinite displacements and other instabilities. To obtain a stable problem you must solve for $min_x E(x)$, which is the exact opposite.

The solution is to introduce some additional variables ξ (known as the spatial kernel), and to solve the max-min or saddle point optimization problem

$$max_{\xi} min_x E(\xi, x)$$

One therefore has two saddle directions: a load-bearing structure is found by computing the minimum energy state using x , while energy absorption of the structure is maximized by solving for the spatial kernel variables ξ .

In general, and specifically for Multidisciplinary Design Optimization (MDO) problems, one does not design merely for energy absorption. A generalized problem can be solved considering the dual problem:

$$min_{\xi} F(\xi(x))$$

where x is computed using

$$min_x f(x(\xi))$$

with f usually taken as the compliance, or the negative value of fundamental frequency, which means the analyst only have to specify F . In such a case one can maximize energy absorption using F while maximize stiffness using f . Similarly, you can minimize mass using F while maximizing stiffness using f .

Introducing constraints into the dual problem

We have the standard objective is

$$f(x)$$

and the constraints as

$$g_i(x) \leq 0$$

The constraints can be split into two sets -- for the one set design sensitivity information can be analytically computed

$$g_i^{ana}(x) \leq 0 \text{ with } i = 1, \dots, n$$

while the other set requires the computation of numerical derivatives using the spatial kernel in the upper problem

$$g_j^{num}(x) \leq 0 \text{ with } j = 1, \dots, m$$

LS-DYNA New Feature and Application

Adding the Lagrange multipliers to the objective gives us the Lagrange function

$$L(\mathbf{x}, \boldsymbol{\lambda}, \boldsymbol{\xi}) = f(\mathbf{x}) + \sum_i \lambda_i g_i^{\text{ana}}(\mathbf{x}) + \sum_j \xi_j g_j^{\text{num}}(\mathbf{x})$$

The constraints needing numerical derivatives are given special treatment. A spatial kernel

$$s(\boldsymbol{\xi}) = \sum_j \xi_j S_j(\boldsymbol{\zeta})$$

is introduced to satisfy these constraints. The kernel is composed of basis functions referring to $\boldsymbol{\zeta}$ the spatial coordinates associated with variable \mathbf{x} and is applied to $f(\mathbf{x})$ which is the function that generates the load bearing structure, which yields

$$L(\mathbf{x}, \boldsymbol{\lambda}, \boldsymbol{\xi}) = [1 + s(\boldsymbol{\xi})]f(\mathbf{x}) + \sum_i \lambda_i g_i^{\text{ana}}(\mathbf{x})$$

The current implementation of the spatial kernel is slightly different, because we roll up all the spatial kernel functions into a surface written as a summation over both the basis functions and the elements as:

$$h(\mathbf{x}) = \frac{1}{n} \sum_{e=1}^N \frac{x_e}{\exp(\xi_0 + \xi_1 S_1(\zeta_e) + \xi_2 S_2(\zeta_e) + \dots)} = 1$$

with x_e a spatial value at element e ($e = 1, \dots, N$), and $\boldsymbol{\xi}$ the solved for to satisfy the constraints. See reference [7] for the details of an implementation.

Expansion to MDO

For multidisciplinary optimization we have the objective as

$$f(\mathbf{x}) = \sum_{lc} w_{lc} f_{lc}(\mathbf{x})$$

in which it should be noted that the load case weights can be used to solve for a subset of the constraints. The constraints are split into two sets as described before -- for the one set design sensitivity information can be computed, while the other set requires the computation of numerical derivatives using the spatial kernel in the upper problem.

As before we can add the Lagrange multipliers to the objective giving the Lagrange function

$$L(\mathbf{x}, \boldsymbol{\lambda}, \boldsymbol{\xi}) = \sum_{lc} w_{lc} [1 + s(\boldsymbol{\xi})] f_{lc}(\mathbf{x}) + \sum_i \lambda_i g_i^{\text{ana}}(\mathbf{x})$$

which contains the high-level variables $[\mathbf{w}, \boldsymbol{\lambda}, \boldsymbol{\xi}]$ used to solve for the constraints.

Solving the dual problem

The dual problem is solved as an upper level problem in the Lagrange multipliers (including weight and spatial kernel variables) and a lower level problem in the topology variables. The lower level problem is solved using the projected subgradient method [12] considering the Lagrange multipliers, while the upper level problem can be solved using finite differences or surrogate models.

The important algorithm settings are the step size (desired mass flow) for the lower level problem and the trust region bounds (move limits) for the upper level problem. The two settings are linked. If the convergence is too noisy then they can both be reset to a smaller value such as “0.25*Default” – in which it must be noted that “Default” is an allowed and recommended part of the expression.

LS-DYNA New Feature and Application

Examples

Benchmark example with a displacement and fundamental frequency constraint.

This is an academic example chosen for benchmark and verification purposes. It can be found as part example problems of LS-TaSC version 4.2. The structure is designed for two load cases – supporting the load as shown as well as for the fundamental frequency. Two constraints are placed on the design: the displacement must be less than 0.008 and the 2nd harmonic of the structure must be larger than 80. Results are shown in Figure 1.

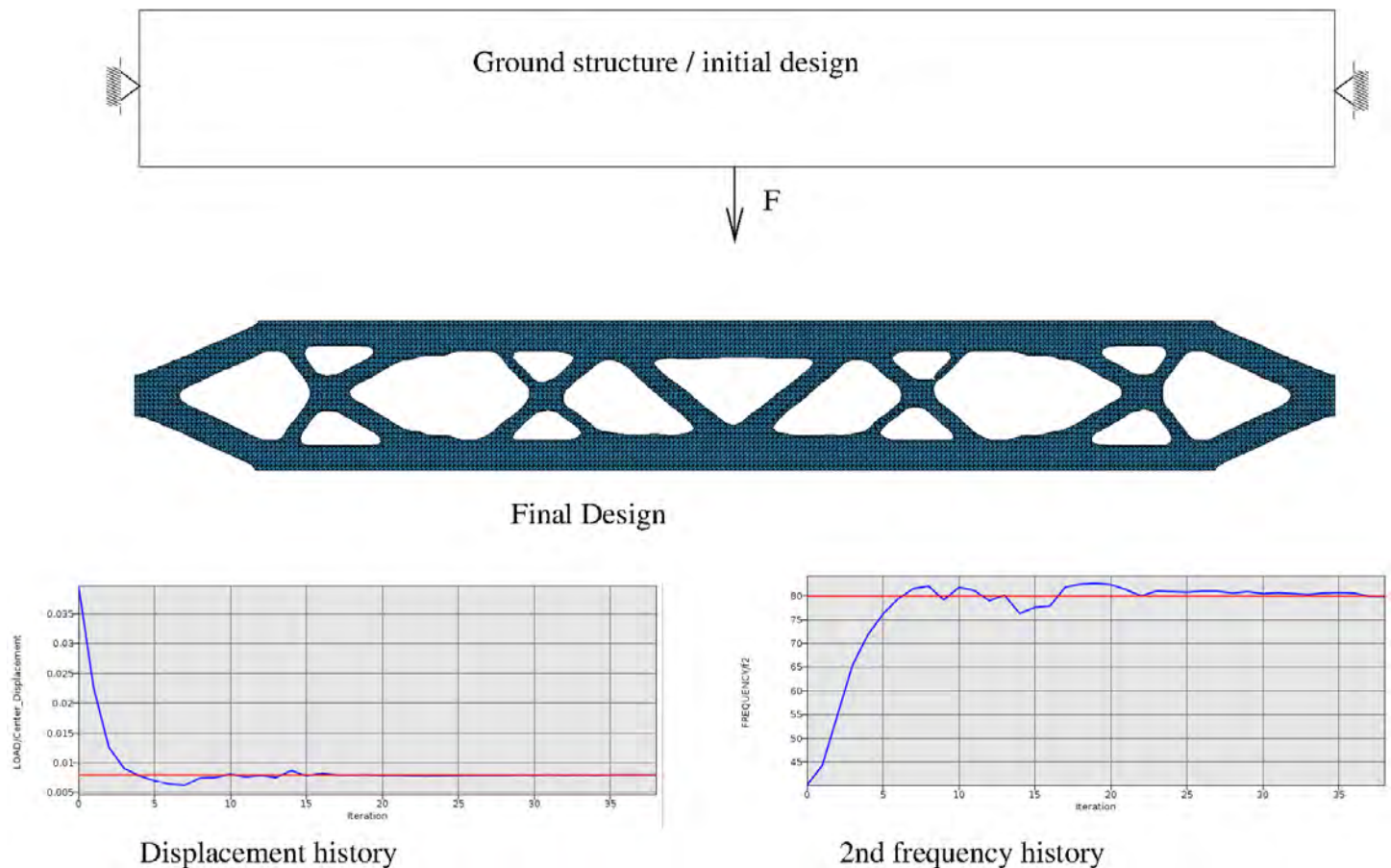

Figure 1 Benchmark example. The ground structure is shown on top with the final design below. The histories of the displacement and 2nd frequency constraints show that design process satisfied the constraints.

Nonlinear Beam Example

For this problem we study the trade-off between the natural frequency and a nonlinear displacement. The multidisciplinary problem is stated as minimizing displacement while subject to a lower bound of 750 on the natural frequency. This problem required a reduction in the step size.

LS-DYNA New Feature and Application

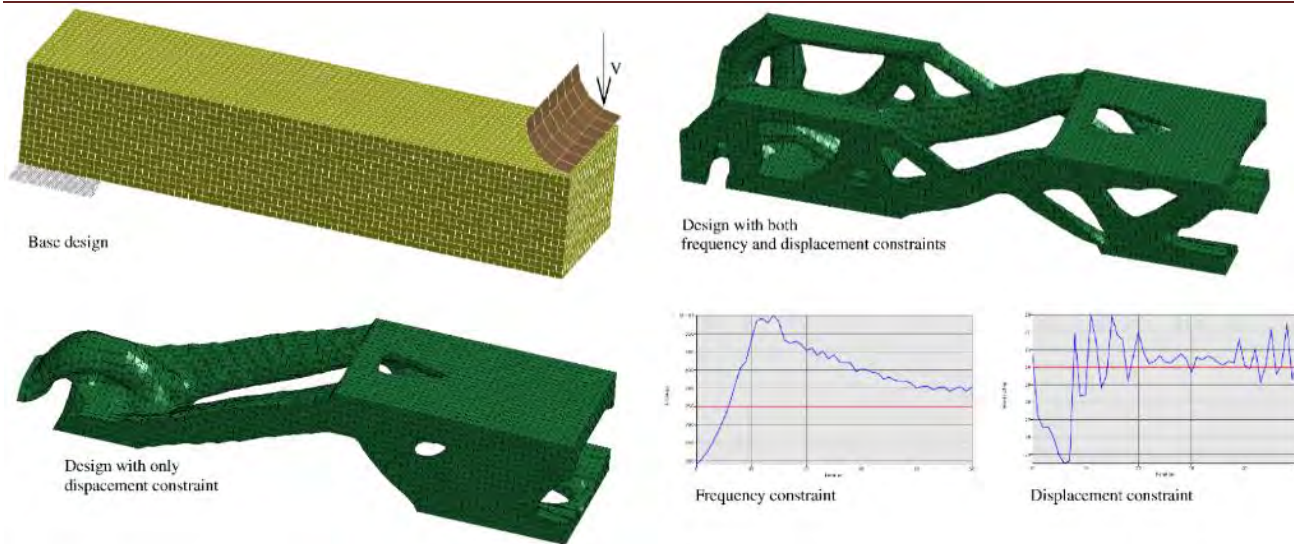
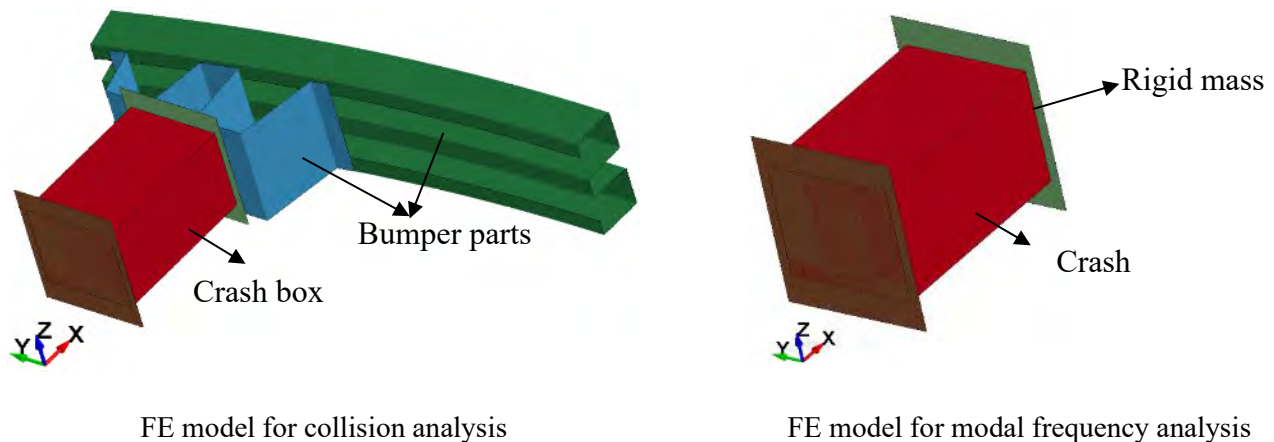

Figure 2 Nonlinear beam example. Shown are the base structure and two designs. The one design used only a displacement constraint and the other both a displacement and natural frequency constraint. The constraint histories for the latter case is also shown.

Crash Box Example

This problem is to perform lightweight optimization of an automotive crash box by considering crashworthiness characteristics along with NVH characteristics. These two characteristics yield a competition between deformability necessary for improving energy absorption and rigidity for improving NVH characteristics of the crash box. A solid design part connected to simplified bumper parts is used as the baseline design of the crash box subject to high-speed collision. However, this FE model cannot be used directly for conducting modal frequency analysis due to the involvement of bumper parts in the model. Therefore, the solid design part of the crash box with rigid mass attached at its front end is used for modal frequency analysis. A multidisciplinary optimization is conducted to minimize mass of the crash box with a constraint on energy absorption ability and two constraints on the frequencies of the first two bending modes with mode tracking. The energy absorption ability of the crash box should meet at least same maximum energy absorption as a reference shell-structured crash box, which is $E^* = 52$ KJ. The frequencies of the first two bending modes in y-direction and z-direction should be larger than 0.73 and 0.71 respectively. Results are shown in Figure 3, Figure 4 and Figure 5.



LS-DYNA New Feature and Application



Final design of crash box

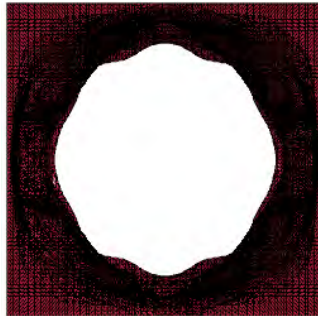

Front view of crash box



Side view of crash box

Figure 3 Crash box example. The FE models for two load cases are shown on top with the final design below displayed in different views.

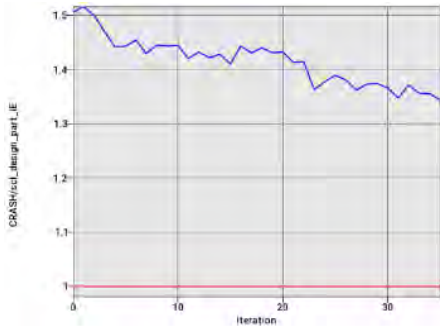

Internal energy history

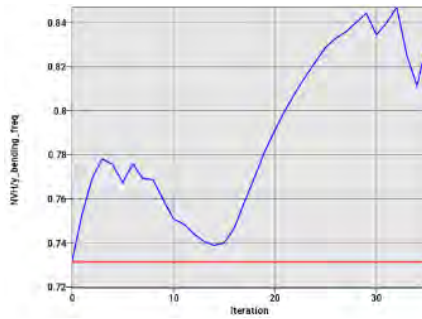

Frequency history of the 1st bending mode in y-direction

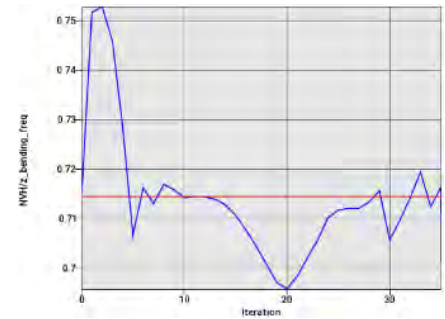

Frequency history of the 1st bending mode in z-direction

Figure 4 Histories of the internal energy and two frequency constraints.

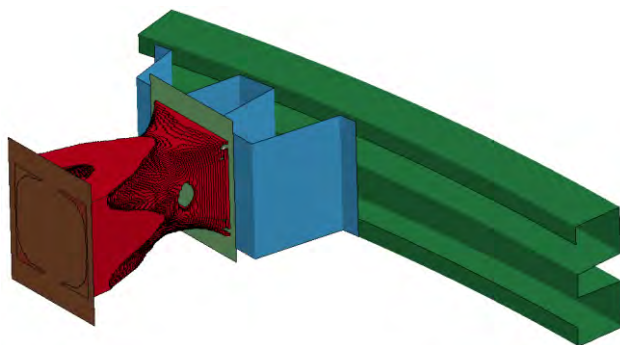

Deformation of crash box and bumper at t = 0 ms (left) and t = 30 ms (right)

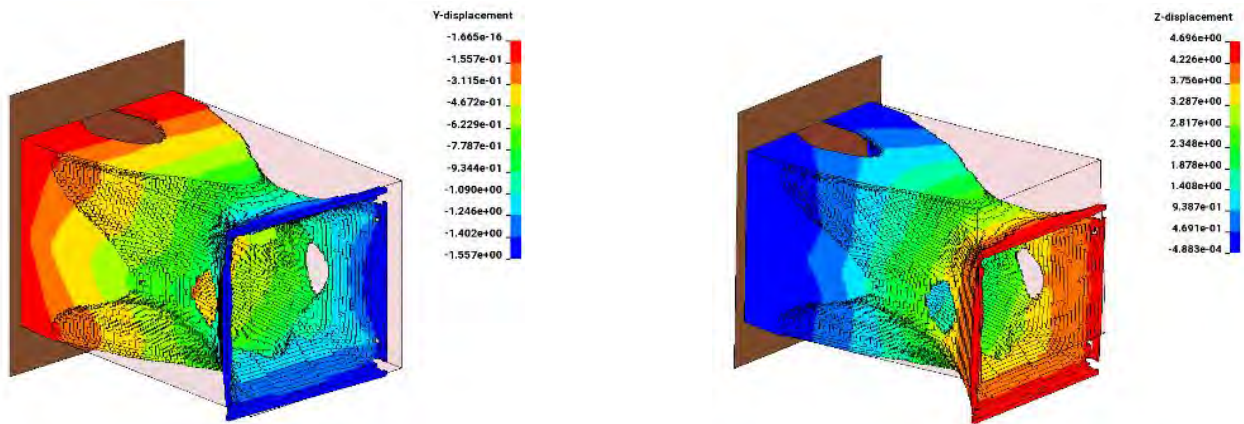

First two bending modes in y-direction (left) and z-direction (right)

Figure 5 The deformed structures for two load cases.

Summary and Conclusions

The paper showed how multidisciplinary topology optimization problems are formulated and solved by formulating a Lagrange function from the multitude of objectives and the constraints. This allows us to solve huge multidisciplinary topology optimization problems incorporating both occupant safety and NVH constraints. can be done by considering the constraints belonging to each discipline.

References

1. J. Deaton, R. Grandhi, A survey of structural and multidisciplinary continuum topology optimization: post 2000, *Struct. Multidiscip. Optim.* 49(1): 1–38, 2014.
2. J. Liu, A. Gaynor, S. Z. K. Chen, K. Suresh, A. Takezawa, L. Li, J. Kato, J. Tang, C. C. L. Wang, L. Cheng, X. Liang, A. C. To, Current and future trends in topology optimization for additive manufacturing, *Struct. Multidiscip. Optim.* 57(6): 2457–2483, 2018.
3. J. Liu, Y. Ma, A survey of manufacturing oriented topology optimization methods, *Adv. Eng. Softw.* 100: 161–175, 2016.
4. T. Iqbal, L. Wang, D. Li, E. Dong, H. Fan, J. Fu, C. Hu, A general multi-objective topology optimization methodology developed for customized design of pelvic prostheses, *Medical Engineering and Physics*, 69: 8– 16, 2019. <https://doi.org/10.1016/j.medengphy.2019.06.008>.
5. I. Gandikota, G. Yi, W. Roux, Crashworthiness and lightweight optimization of an automotive crash box using LS-TaSC, *FEA Information Engineering Solutions*, October 2019.
6. K. Weider, A. Schumacher, Adjoint method for topological derivatives for optimization tasks with material and geometrical nonlinearities, in: R. H. et al (Ed.), *Proceedings of the 6th International Conference on Engineering Optimization*, Springer, Cham, 2018.
7. W. Roux, G. Yi, I. Gandikota, A spatial kernel approach for topology optimization, *Computer Methods in Applied Mechanics and Engineering*, 361: 112794, 2020. <https://doi.org/10.1016/j.cma.2019.112794>
8. W. Roux, Structural topology optimization using numerical derivatives, Japan patent 6548532. Filed September, 2015. Issued July 1, 2019.
9. W. Roux, Constrained topology optimization using multi-point perturbations of global variables, *USNCCM 13*, 2015. doi:10.13140/RG.2.2.35972.88969.
10. W. Roux, A feasible minimum energy state method for constrained, multi-disciplinary topology optimization problems, *USNCCM 14*, 2017. doi:10.13140/RG.2.2.24228.83845.
11. W. Roux, The LS-TaSC multipoint method for constrained topology optimization, in: *14th International LS-DYNA Users Conference*, Dearborn MI, 12-14 June, 2016.
12. W. Roux, G. Yi, I. Gandikota, Implementation of the projected subgradient method in LS-TaSC™, in: *15th International LS-DYNA Users Conference*, Dearborn MI, 10-12 June, 2018.



BETA CAE Systems.

www.beta-cae.com

BETA CAE Systems - ANSA

An advanced multidisciplinary CAE pre-processing tool that provides all the necessary functionality for full-model build up, from CAD data to ready-to-run solver input file, in a single integrated environment. ANSA is a full product modeler for LS-DYNA, with integrated Data Management and Process Automation. ANSA can also be directly coupled with LS-OPT of LST, an ANSYS company to provide an integrated solution in the field of optimization.

BETA CAE Systems μ ETA

Is a multi-purpose post-processor meeting diverging needs from various CAE disciplines. It owes its success to its impressive performance, innovative features and capabilities of interaction between animations, plots, videos, reports and other objects. It offers extensive support and handling of LS-DYNA 2D and 3D results, including those compressed with SCAI's FEMZIP software.

Solutions for:

Process Automation - Data Management – Meshing – Durability - Crash & Safety NVH - CFD
- Thermal analysis - Optimization - Powertrain
Products made of composite materials - Analysis Tools -
Maritime and Offshore Design - Aerospace engineering - Biomechanics



ETA – Engineering Technology Associates
etainfo@eta.com

www.eta.com

Invention Suite™

Invention Suite™ is an enterprise-level CAE software solution, enabling concept to product. Invention's first set of tools will be released soon, in the form of an advanced Pre & Post processor, called PreSys.

Invention's unified and streamlined product architecture will provide users access to all of the suite's software tools. By design, its products will offer a high performance modeling and post-processing system, while providing a robust path for the integration of new tools and third party applications.

PreSys

Invention's core FE modeling toolset. It is the successor to ETA's VPG/PrePost and FEMB products. PreSys offers an easy to use interface, with drop-down

menus and toolbars, increased graphics speed and detailed graphics capabilities. These types of capabilities are combined with powerful, robust and accurate modeling functions.

VPG

Advanced systems analysis package. VPG delivers a unique set of tools which allow engineers to create and visualize, through its modules--structure, safety, drop test, and blast analyses.

DYNAFORM

Complete Die System Simulation Solution. The most accurate die analysis solution available today. Its formability simulation creates a "virtual tryout", predicting forming problems such as cracking, wrinkling, thinning and spring-back before any physical tooling is produced.



get it right® Visual-Environment is an integrative simulation platform for simulation tools operating either concurrently or standalone for various solver. Comprehensive and integrated solutions for meshing, pre/post processing, process automation and simulation data management are available within same environment enabling seamless execution and automation of tedious workflows. This very open and versatile environment simplifies the work of CAE engineers across the enterprise by facilitating collaboration and data sharing leading to increase of productivity.

Visual-Crash DYNA provides advanced preprocessing functionality for LS-DYNA users, e.g. fast iteration and rapid model revision processes, from data input to visualization for crashworthiness simulation and design. It ensures quick model browsing, advanced mesh editing capabilities and rapid graphical assembly of system models. Visual-Crash DYNA allows graphical creation, modification and deletion of LS-DYNA entities. It comprises tools for checking model quality and simulation parameters prior to launching calculations with the solver. These tools help in correcting errors and fine-tuning the model and simulation before submitting it to the solver, thus saving time and resources.

Several high productivity tools such as advanced dummy positioning, seat morphing, belt fitting and airbag folder are provided in **Visual-Safe**, a dedicated application to safety utilities.

Visual-Mesh is a complete meshing tool supporting CAD import, 1D/2D/3D meshing and editing for linear and quadratic meshes. It supports all meshing capabilities, like shell and solid automesh, batch meshing, topo mesh, layer mesh, etc. A convenient Meshing Process guides

you to mesh the given CAD component or full vehicle automatically.

Visual-Viewer built on a multi-page/multi-plot environment, enables data grouping into pages and plots. The application allows creation of any number of pages with up to 16 windows on a single page. These windows can be plot, animation, video, model or drawing block windows. Visual-Viewer performs automated tasks and generates customized reports and thereby increasing engineers' productivity.

Visual-Process provides a whole suite of generic templates based on LS-DYNA solver (et altera). It enables seamless and interactive process automation through customizable LS-DYNA based templates for automated CAE workflows.

All generic process templates are easily accessible within the unique framework of Visual-Environment and can be customized upon request and based on customer's needs.

VisualDSS is a framework for Simulation Data and Process Management which connects with Visual-Environment and supports product engineering teams, irrespective of their geographic location, to make correct and realistic decisions throughout the virtual prototyping phase. VisualDSS supports seamless connection with various CAD/PLM systems to extract the data required for building virtual tests as well as building and chaining several virtual tests upstream and downstream to achieve an integrated process. It enables the capture, storage and reuse of enterprise knowledge and best practices, as well as the automation of repetitive and cumbersome tasks in a virtual prototyping process, the propagation of engineering changes or design changes from one domain to another.



JSOL Corporation

www.jsol.co.jp/english/cae/

HYCRASH

Easy-to-use one step solver, for Stamping-Crash Coupled Analysis. HYCRASH only requires the panels' geometry to calculate manufacturing process effect, geometry of die are not necessary. Additionally, as this is target to usage of crash/strength analysis, even forming analysis data is not needed. If only crash/strength analysis data exists and panel ids is defined. HYCRASH extract panels to calculate it's strain, thickness, and map them to the original data.

JSTAMP/NV

As an integrated press forming simulation system for virtual tool shop

the JSTAMP/NV meets the various industrial needs from the areas of automobile, electronics, iron and steel, etc. The JSTAMP/NV gives satisfaction to engineers, reliability to products, and robustness to tool shop via the advanced technology of the JSOL Corporation.

JMAG

JMAG uses the latest techniques to accurately model complex geometries, material properties, and thermal and structural phenomena associated with electromagnetic fields. With its excellent analysis capabilities, JMAG assists your manufacturing process.



Livermore Software Technology, an ANSYS Company
www.lstc.com

LS-DYNA

A general-purpose finite element program capable of simulating complex real world problems. It is used by the automobile, aerospace, construction, military, manufacturing, and bioengineering industries. LS-DYNA is optimized for shared and distributed memory Unix, Linux, and Windows based, platforms, and it is fully QA'd by LST, an ANSYS company. The code's origins lie in highly nonlinear, transient dynamic finite element analysis using explicit time integration.

LS-PrePost

An advanced pre and post-processor that is delivered free with LS-DYNA. The user interface is designed to be both efficient and intuitive. LS-PrePost runs on Windows, Linux, and Macs utilizing OpenGL graphics to achieve fast rendering and XY plotting.

LS-OPT

LS-OPT is a standalone Design Optimization and Probabilistic Analysis package with an interface to LS-DYNA. The graphical preprocessor LS-OPTui facilitates definition of the design input and the creation of a command

file while the postprocessor provides output such as approximation accuracy, optimization convergence, tradeoff curves, anthill plots and the relative importance of design variables.

LS-TaSC

A Topology and Shape Computation tool. Developed for engineering analysts who need to optimize structures, LS-TaSC works with both the implicit and explicit solvers of LS-DYNA. LS-TaSC handles topology optimization of large non-linear problems, involving dynamic loads and contact conditions.

LST, AN ANSYS COMPANY Dummy Models

Anthropomorphic Test Devices (ATDs), as known as "crash test dummies", are life-size mannequins equipped with sensors that measure forces, moments, displacements, and accelerations.

LST, AN ANSYS COMPANY Barrier Models

LSTC offers several Offset Deformable Barrier (ODB) and Movable Deformable Barrier (MDB) model.

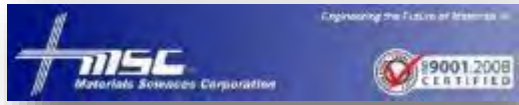

Material Sciences Corporation

www.materials-sciences.com

Materials Sciences Corporation has provided engineering services to the composites industry since 1970. During this time, we have participated in numerous programs that demonstrate our ability to: perform advanced composite design, analysis and testing; provide overall program management; work in a team environment; and transition new product development to the military and commercial sectors. MSC's corporate mission has expanded beyond basic research and development now to include transitioning its proprietary technologies from the research lab into innovative new products. This commitment is demonstrated through increased staffing and a more than 3-fold expansion of facilities to allow in-house manufacturing and testing of advanced composite materials and structures.

Materials Sciences Corporation (MSC) MAT161/162 - enhanced features have been added to the Dynamic Composite Simulator module of LS-DYNA.

This enhancement to LS-DYNA, known as MAT161/162, enables the most effective and accurate dynamic progressive failure modeling of composite structures to enable the most effective and accurate dynamic progressive

failure modeling of composite structures currently available.

MSC/LS-DYNA Composite Software and Database -

Fact Sheet: <http://www.materials-sciences.com/dyna-factsheet.pdf>

- MSC and LSTC have joined forces in developing this powerful composite dynamic analysis code.
- For the first time, users will have the enhanced ability to simulate explicit dynamic engineering problems for composite structures.
- The integration of this module, known as 'MAT 161', into LS-DYNA allows users to account for progressive damage of various fiber, matrix and interply delamination failure modes.
- Implementing this code will result in the ability to optimize the design of composite structures, with significantly improved survivability under various blast and ballistic threats.

MSC's LS-DYNA module can be used to characterize a variety of composite structures in numerous applications—such as this composite hull under blast.



LS-DYNA ENVIRONMENT

Oasys Ltd. LS-DYNA Environment

www.oasys-software.com/dyna

The Oasys Suite of software is exclusively written for LS-DYNA® and is used worldwide by many of the largest LS-DYNA® customers. The suite comprises of:

Oasys PRIMER

Key benefits:

- Pre-Processor created specifically for LS-DYNA®
- Compatible with the latest version of LS-DYNA®
- Maintains the integrity of data
- Over 6000 checks and warnings – many auto-fixable
- Specialist tools for occupant positioning, seatbelt fitting and seat squashing (including setting up pre-simulations)
- Many features for model modification, such as part replace
- Ability to position and depenetrate impactors at multiple locations and produce many input decks automatically (e.g. pedestrian impact, interior head impact)

- Contact penetration checking and fixing
- Connection feature for creation and management of connection entities.
- Support for Volume III keywords and large format/long labels
- Powerful scripting capabilities allowing the user to create custom features and processes

www.oasys-software.com/dyna

Oasys D3PLOT

Key benefits:

- Powerful 3D visualization post-processor created specifically for LS-DYNA®
- Fast, high quality graphics
- Easy, in-depth access to LS-DYNA® results
- Scripting capabilities allowing the user to speed up post-processing, as well as creating user defined data components



www.predictiveengineering.com

Predictive Engineering provides finite element analysis consulting services, software, training and support to a broad range of engineering companies across North America. We strive to exceed client expectations for accuracy, timeliness and knowledge transfer. Our process is both cost-effective and collaborative, ensuring all clients are reference clients.

Our mission is to be honest brokers of information in our consulting services and the software we represent.

Our History

Since 1995, Predictive Engineering has continually expanded its client base. Our clients include many large organizations and industry leaders such as SpaceX, Nike, General Electric, Navistar, FLIR Systems, Sierra Nevada Corp, Georgia-Pacific, Intel, Messier-Dowty and more. Over the years, Predictive Engineering has successfully completed more than 800 projects, and has set itself apart on its strong FEA, CFD and LS-DYNA consulting services.



Shanghai Hengstar

www.hengstar.com

Center of Excellence: Hengstar Technology is the first LS-DYNA training center of excellence in China. As part of its expanding commitment to helping CAE engineers in China, Hengstar Technology will continue to organize high level training courses, seminars, workshops, forums etc., and will also continue to support CAE events such as: China CAE Annual Conference; China Conference of Automotive Safety Technology; International Forum of Automotive Traffic Safety in China; LS-DYNA China users conference etc.

On Site Training: Hengstar Technology also provides customer customized training programs on-site at the company facility. Training is tailored for customer needs using LS-DYNA such as material test and input keyword preparing; CAE process automation with customized script program; Simulation result correlation with the test result; Special topics with new LS-DYNA features etc..

Distribution & Support: Hengstar distributes and supports LS-DYNA, LS-OPT, LS-Prepost, LS-TaSC, LSTC FEA Models; Hongsheng Lu, previously was directly employed by LSTC before opening his distributorship in China for LSTC software. Hongsheng visits LSTC often to keep update on the latest software features.

Hengstar also distributes and supports d3View; Genesis, Visual DOC, ELSDYNA; Visual-Crash Dyna, Visual-Process, Visual-Environment; EnkiBonnet; and DynaX & MadyX etc.

Consulting

As a consulting company, Hengstar focuses on LS-DYNA applications such as crash and safety, durability, bird strike, stamping, forging, concrete structures, drop analysis, blast response, penetration etc with using LS-DYNA's advanced methods: FEA, ALE, SPH, EFG, DEM, ICFD, EM, CSEC..

Contact: JSOL Corporation Engineering Technology Division cae-info@sci.jsol.co.jp



**Cloud computing services
for
JSOL Corporation LS-DYNA users in Japan**

**JSOL Corporation is cooperating with chosen
cloud computing services**

JSOL Corporation, a Japanese LS-DYNA distributor for Japanese LS-DYNA customers.

LS-DYNA customers in industries / academia / consultancies are facing increased needs for additional LS-DYNA cores

In calculations of optimization, robustness, statistical analysis, we find that an increase in cores of LS-DYNA are needed, for short term extra projects or cores.

JSOL Corporation is cooperating with some cloud computing services for JSOL's LS-DYNA users and willing to provide short term license.

This service is offered to customers using Cloud License fee schedule, the additional fee is less expensive than purchasing yearly license.

The following services are available (only in Japanese). HPC OnLine:

NEC Solution Innovators, Ltd. - http://jpn.nec.com/manufacture/machinery/hpc_online/

Focus - Foundation for Computational Science
<http://www.j-focus.or.jp>

Platform Computation Cloud - CreDist.Inc.

PLEXUS CAE

Information Services International-Dentsu, Ltd. (ISID) <https://portal.plexusplm.com/plexus-cae/>

SCSK Corporation - <http://www.scsk.jp/product/keyword/keyword07.html>

Cloud - HPC Services - Subscription *RESCALE*

www.rescale.com



Rescale: Cloud Simulation Platform

The Power of Simulation Innovation

We believe in the power of innovation. Engineering and science designs and ideas are limitless. So why should your hardware and software be limited? You shouldn't have to choose between expanding your simulations or saving time and budget.

Using the power of cloud technology combined with LS-DYNA allows you to:

- Accelerate complex simulations and fully explore the design space
- Optimize the analysis process with hourly software and hardware resources
- Leverage agile IT resources to provide flexibility and scalability

True On-Demand, Global Infrastructure

Teams are no longer in one location, country, or even continent. However, company data centers are often in one place, and everyone must connect in, regardless of office. For engineers across different regions, this can cause connection issues, wasted time, and product delays.

Rescale has strategic/technology partnerships with infrastructure and software providers to offer the following:

- Largest global hardware footprint – GPUs, Xeon Phi, InfiniBand
- Customizable configurations to meet every simulation demand
- Worldwide resource access provides industry-leading tools to every team
- Pay-per-use business model means you only pay for the resources you use
- True on-demand resources – no more queues

ScaleX Enterprise: Transform IT, Empower Engineers, Unleash Innovation

The ScaleX Enterprise simulation platform provides scalability and flexibility to companies while offering enterprise IT and management teams the opportunity to expand and empower their organizations.

Cloud - HPC Services - Subscription **RESCALE**

Rescale Cloud Simulation Platform

www.rescale.com

ScaleX Enterprise allows enterprise companies to stay at the leading edge of computing technology while maximizing product design and accelerating the time to market by providing:

- Collaboration tools
- Administrative control
- API/Scheduler integration
- On-premise HPC integration

Industry-Leading Security

Rescale has built proprietary, industry-leading security solutions into the platform, meeting the needs of customers in the most demanding and competitive industries and markets.

- Manage engineering teams with user authentication and administrative controls
- Data is secure every step of the way with end-to-end data encryption
- Jobs run on isolated, kernel-encrypted, private clusters
- Data centers include biometric entry authentication
- Platforms routinely submit to independent external security audits

Rescale maintains key relationships to provide LS-DYNA on demand on a global scale. If you have a need to accelerate the simulation process and be an innovative leader, contact Rescale or the following partners to begin running LS-DYNA on Rescale's industry-leading cloud simulation platform.

LSTC - DYNAmore GmbH JSOL Corporation

Rescale, Inc. - 1-855-737-2253 (1-855-RESCALE) - info@rescale.com

944 Market St. #300, San Francisco, CA 94102 USA



ESI Cloud offers designers and engineers cloud-based computer aided engineering (CAE) solutions across physics and engineering disciplines.

ESI Cloud combines ESI's industry tested virtual engineering solutions integrated onto ESI's Cloud Platform with browser based modeling,

With ESI Cloud users can choose from two basic usage models:

- An end-to-end SaaS model: Where modeling, multi-physics solving, results visualization and collaboration are conducted in the cloud through a web browser.
- A Hybrid model: Where modeling is done on desktop with solve, visualization and collaboration done in the cloud through a web browser.

Virtual Performance Solution:

ESI Cloud offers ESI's flagship Virtual Performance Solution (VPS) for multi-domain performance simulation as a hybrid offering on its cloud platform. With this offering, users can harness the power of Virtual Performance Solution, leading multi-domain CAE solution for virtual engineering of crash, safety, comfort, NVH (noise, vibration and harshness), acoustics, stiffness and durability.

In this hybrid model, users utilize VPS on their desktop for modeling including geometry, meshing and simulation set up. ESI Cloud is then used for high performance computing with an integrated visualization and real time collaboration offering through a web browser.

The benefits of VPS hybrid on ESI Cloud include:

- Running large concurrent simulations on demand
- On demand access to scalable and secured cloud HPC resources
- Three tiered security strategy for your data
- Visualization of large simulation data sets
- Real-time browser based visualization and collaboration
- Time and cost reduction for data transfer between cloud and desktop environments
- Support, consulting and training services with ESI's engineering teams

VPS On Demand

ESI Cloud features the Virtual Performance Solution (VPS) enabling engineers to analyze and test products, components, parts or material used in different engineering domains including crash and high velocity impact, occupant safety, NVH and interior acoustics, static and dynamic load cases. The solution enables VPS users to overcome hardware limitations and to drastically reduce their simulation time by running on demand very large concurrent simulations that take advantage of the flexible nature of cloud computing.

Key solution capabilities:

- Access to various physics for multi-domain optimization
- Flexible hybrid model from desktop to cloud computing
- On demand provisioning of hardware resources
- Distributed parallel processing using MPI (Message Passing Interface) protocol
- Distributed parallel computing with 10 Gb/s high speed interconnects

Result visualization

ESI Cloud deploys both client-side and server-side rendering technologies. This enables the full interactivity needed during the simulation workflow along with the ability to handle large data generated for 3D result visualization in the browser, removing the need for time consuming data transfers. Additionally ESI Cloud visualization engine enables the comparisons of different results through a multiple window user interface design.

Key result visualization capabilities:

- CPU or GPU based client and server side rendering
- Mobility with desktop like performance through the browser
- 2D/3D VPS contour plots and animations
- Custom multi-window system for 2D plots and 3D contours
- Zooming, panning, rotating, and sectioning of multiple windows

Collaboration

To enable real time multi-user and multi company collaboration, ESI Cloud offers extensive synchronous and asynchronous collaboration capabilities. Several users can view the same project, interact with the same model results, pass control from one to another. Any markups, discussions or annotations can be archived for future reference or be assigned as tasks to other members of the team.

Key collaboration capabilities:

- Data, workflow or project asynchronous collaboration
- Multi-user, browser based collaboration for CAD, geometry, mesh and results models
- Real-time design review with notes, annotations and images archiving and retrieval
- Email invite to non ESI Cloud users for real time collaboration

TOYOTA - Total Human Model for Safety – THUMS



The Total Human Model for Safety, or THUMS®, is a joint development of Toyota Motor Corporation and Toyota Central R&D Labs. Unlike dummy models, which are simplified representation of humans, THUMS represents actual humans in detail, including the outer shape, but also bones, muscles, ligaments, tendons, and internal organs. Therefore, THUMS can be used in automotive crash simulations to identify safety problems and find their solutions.

Each of the different sized models is available as sitting model to represent vehicle occupants



and as standing model to represent pedestrians.



The internal organs were modeled based on high resolution CT-scans.

THUMS is limited to civilian use and may under no circumstances be used in military applications.

LSTC is the US distributor for THUMS. Commercial and academic licenses are available.

For information please contact: THUMS@lstc.com

THUMS®, is a registered trademark of Toyota Central R&D Labs.

ATD - Human Models - Barrier

LST, An ANSYS Company – Dummy Models

Crash Test Dummies (ATD)

Meeting the need of their LS-DYNA users for an affordable crash test dummy (ATD), LSTC offers the LSTC developed dummies at no cost to LS-DYNA users.

LSTC continues development on the LSTC Dummy models with the help and support of their customers. Some of the models are joint developments with their partners.

e-mail to: atds@lstc.com

Models completed and available
(in at least an alpha version)

- Hybrid III Rigid-FE Adults
- Hybrid III 50th percentile FAST
- Hybrid III 5th percentile detailed
- Hybrid III 50th percentile detailed
- Hybrid III 50th percentile standing
- EuroSID 2
- EuroSID 2re
- SID-IIs Revision D
- USSID
- Free Motion Headform
- Pedestrian Legform Impactors

Models In Development

- Hybrid III 95th percentile detailed
- Hybrid III 3-year-old
- Hybrid II
- WorldSID 50th percentile
- THOR NT FAST
- Ejection Mitigation Headform

Planned Models

- FAA Hybrid III
- FAST version of THOR NT
- FAST version of EuroSID 2
- FAST version of EuroSID 2re
- Pedestrian Headforms
- Q-Series Child Dummies
- FLEX-PLI



ATD - Human Models - Barrier

LST, An ANSYS Company – Barrier Models

Meeting the need of their LS-DYNA users for affordable barrier models, LSTC offers the LSTC developed barrier models at no cost to LS-DYNA users.

LSTC offers several Offset Deformable Barrier (ODB) and Movable Deformable Barrier (MDB) models:

- ODB modeled with shell elements
- ODB modeled with solid elements
- ODB modeled with a combination of shell and solid elements
- MDB according to FMVSS 214 modeled with shell elements
- MDB according to FMVSS 214 modeled with solid elements
- MDB according to ECE R-95 modeled with shell elements
- AE-MDB modeled with shell elements
- IIHS MDB modeled with shell elements
- IIHS MDB modeled with solid elements
- RCAR bumper barrier
- RMDB modeled with shell and solid elements

LSTC ODB and MDB models are developed to correlate to several tests provided by our customers. These tests are proprietary data and are not currently available to the public.

All current models can be obtained through our webpage in the LSTC Models download section or through your LS-DYNA distributor.

To submit questions, suggestions, or feedback about LSTC's models, please send an e-mail to: atds@lstc.com. Also, please contact us if you would like to help improve these models by sharing test data.



Social Media



FACEBOOK

[BETA CAE Systems](#)

[ESI Group](#)

[CADFEM](#)



TWITTER

[BETA CAE Systems](#)

[ETA](#)

[CADFEM](#)

[ESI Group](#)



LINKEDIN

[BETA CAE Systems](#)

[DYNAmore Nordic](#)

[ESI Group](#)

[CADFEM](#)

[ETA](#)



YOUTUBE

YOUTUBE Channel

[BETA CAE Systems](#)

[CADFEM](#)

[ESI Group](#)

[ETA](#)

[Lancemore](#)

WebSite URL

www.beta-cae.com

www.cadfem.de

www.esi-group.com

www.eta.com

www.lancemore.jp/index_en.html

GOOGLE+

[BETA CAE Systems](#)